

Софтвери у грађевинарству

мр Вуле Алексић, проф.

Предавање VII

ДИМЕНЗИОНИСАЊЕ

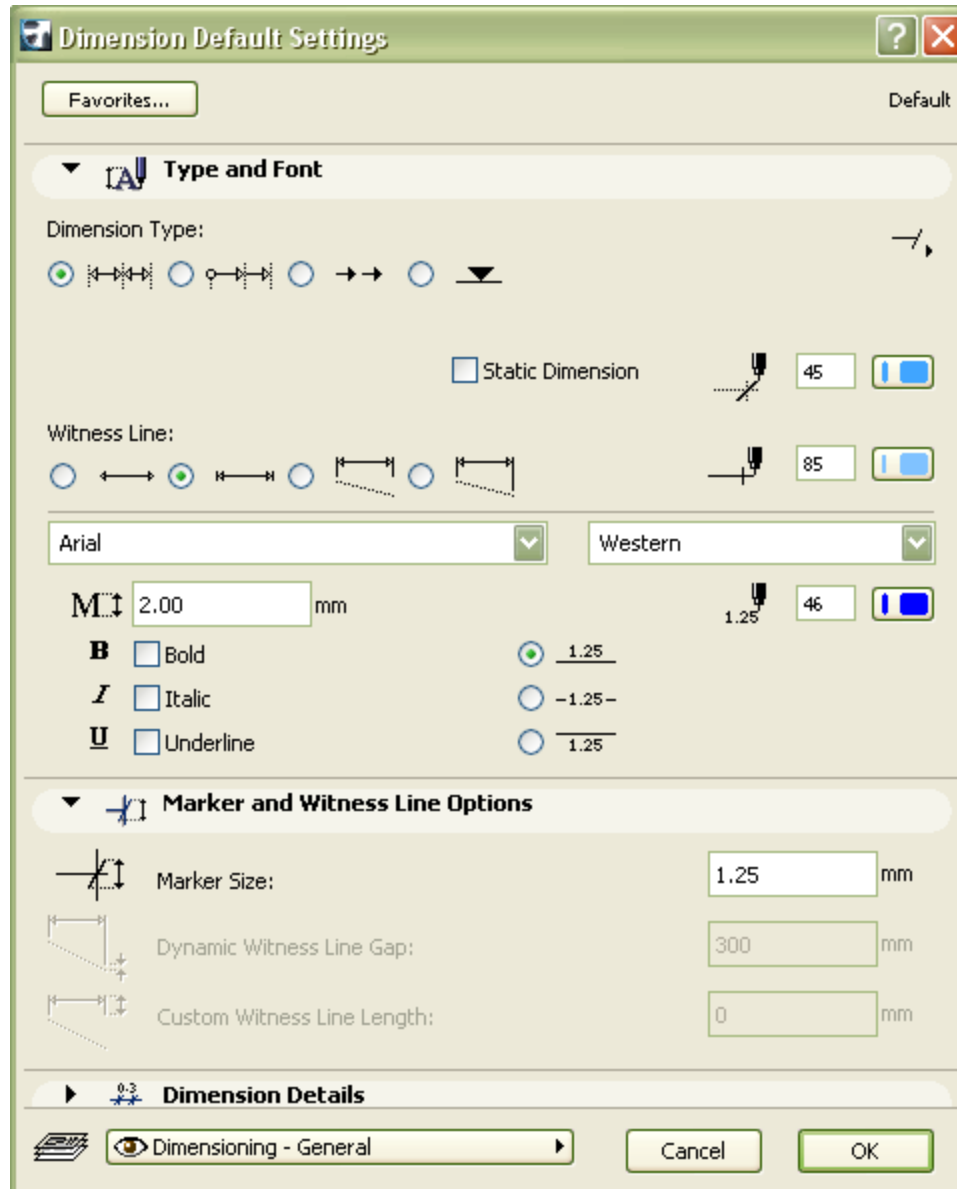

ДИМЕНЗИОНИСАЊЕ

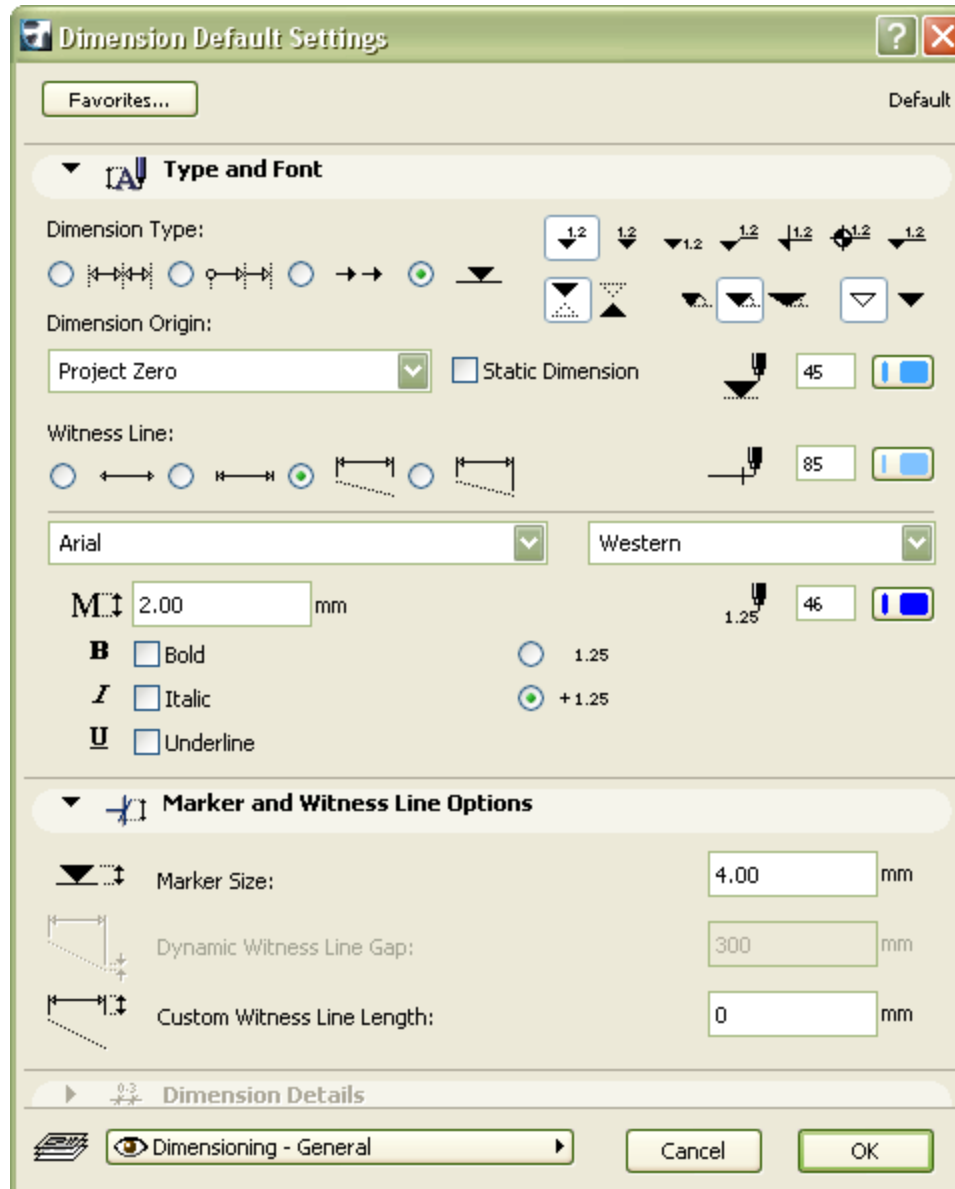

Димензионисање

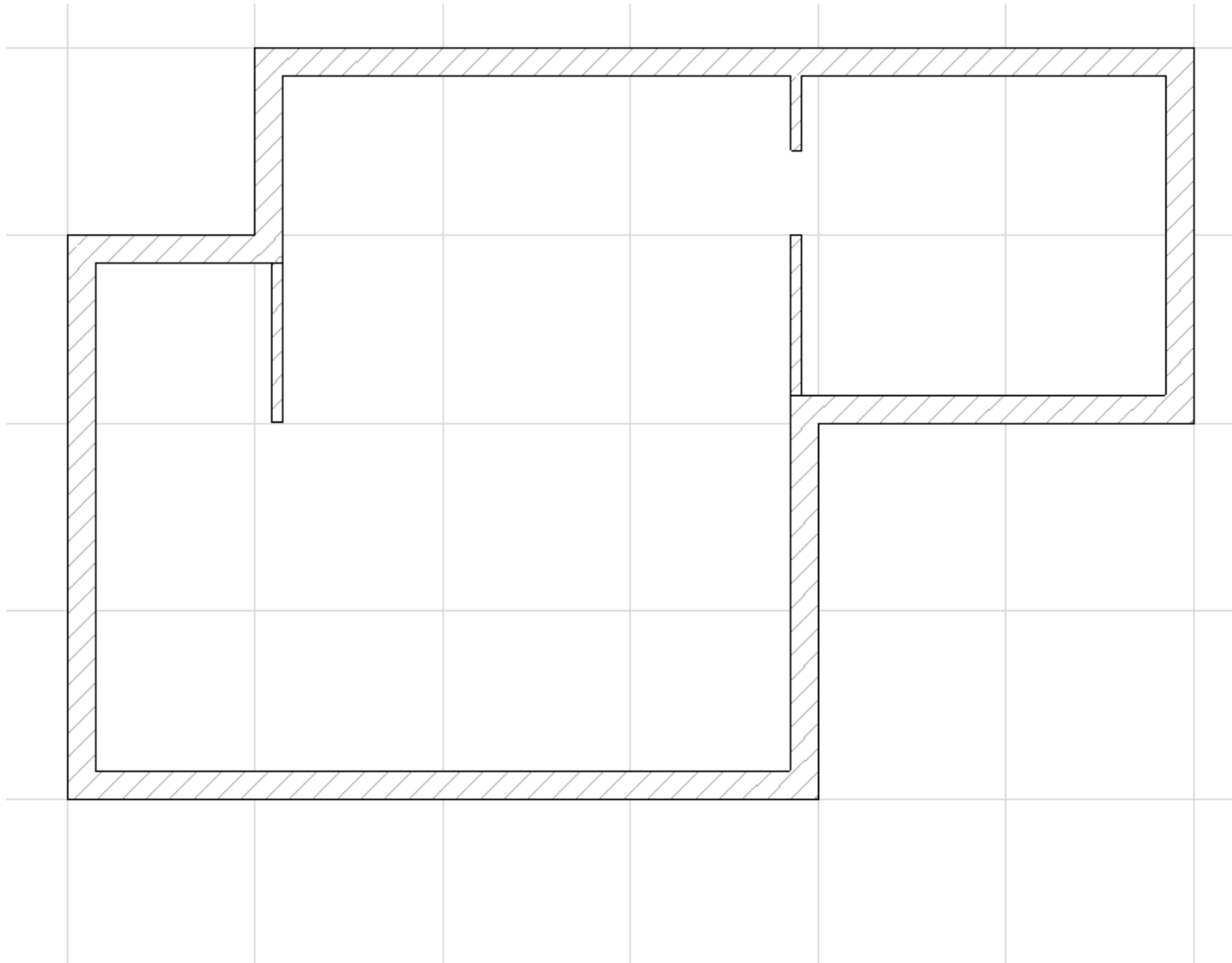

Димензионисање

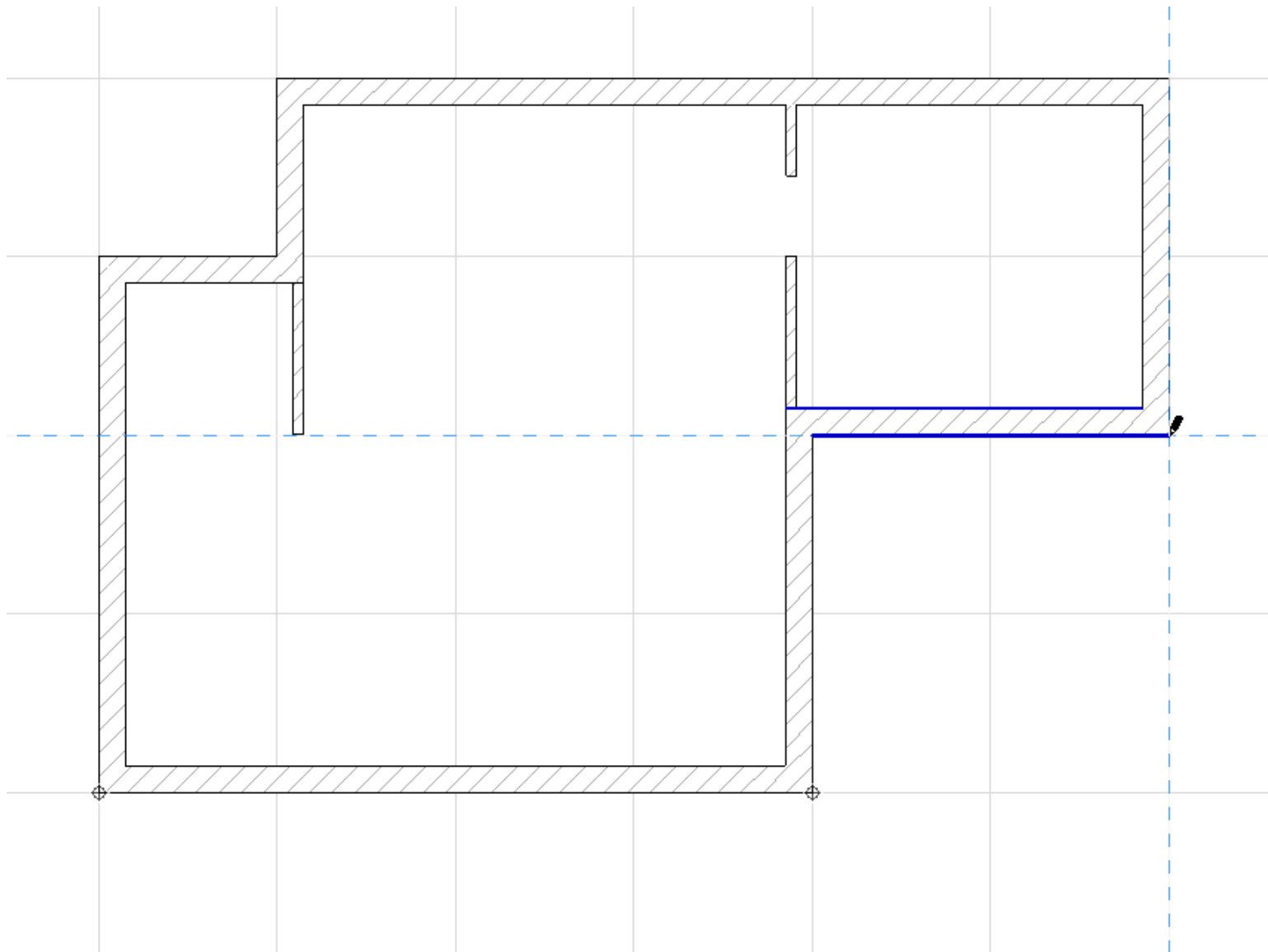

Димензионисање

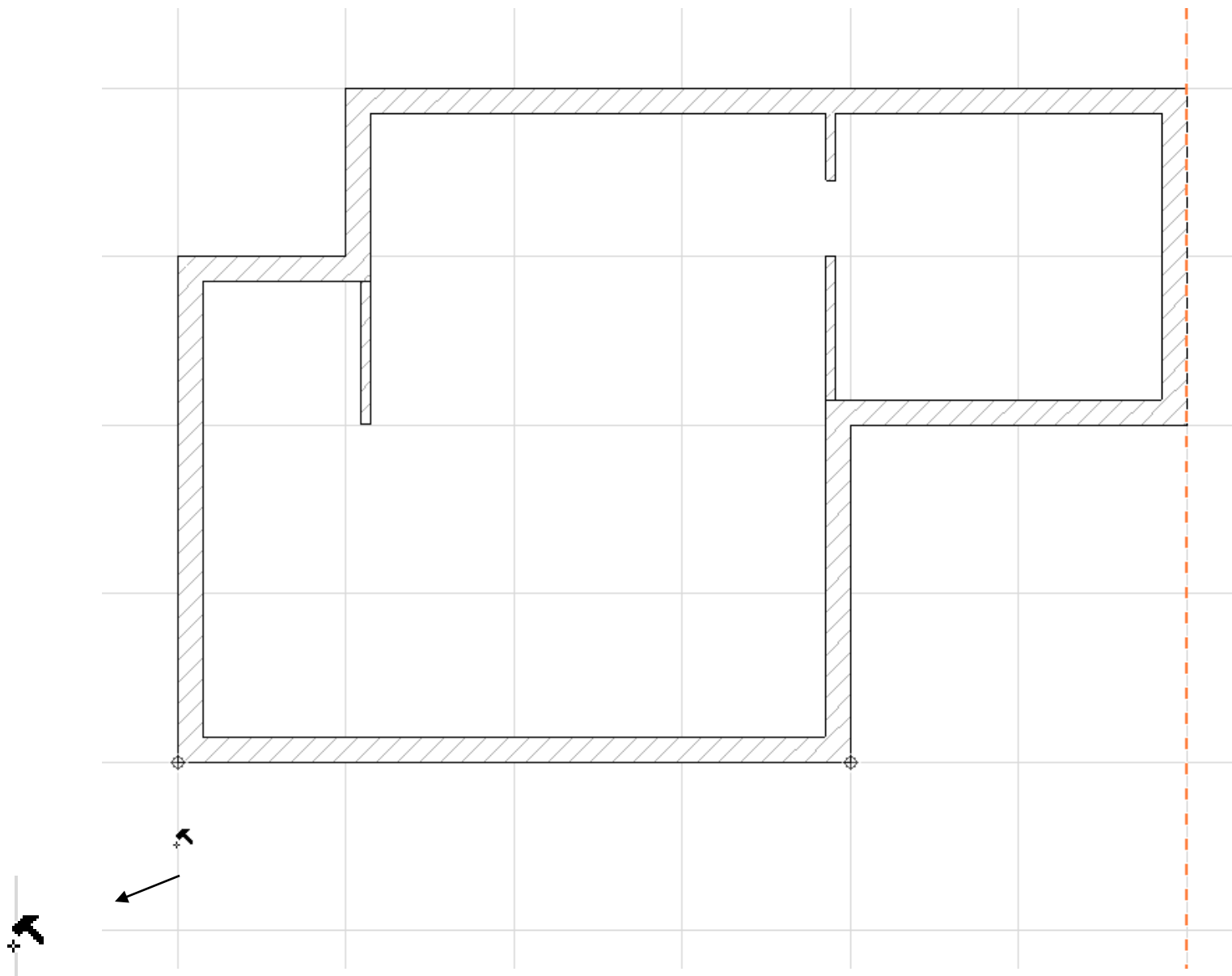

Димензионисање

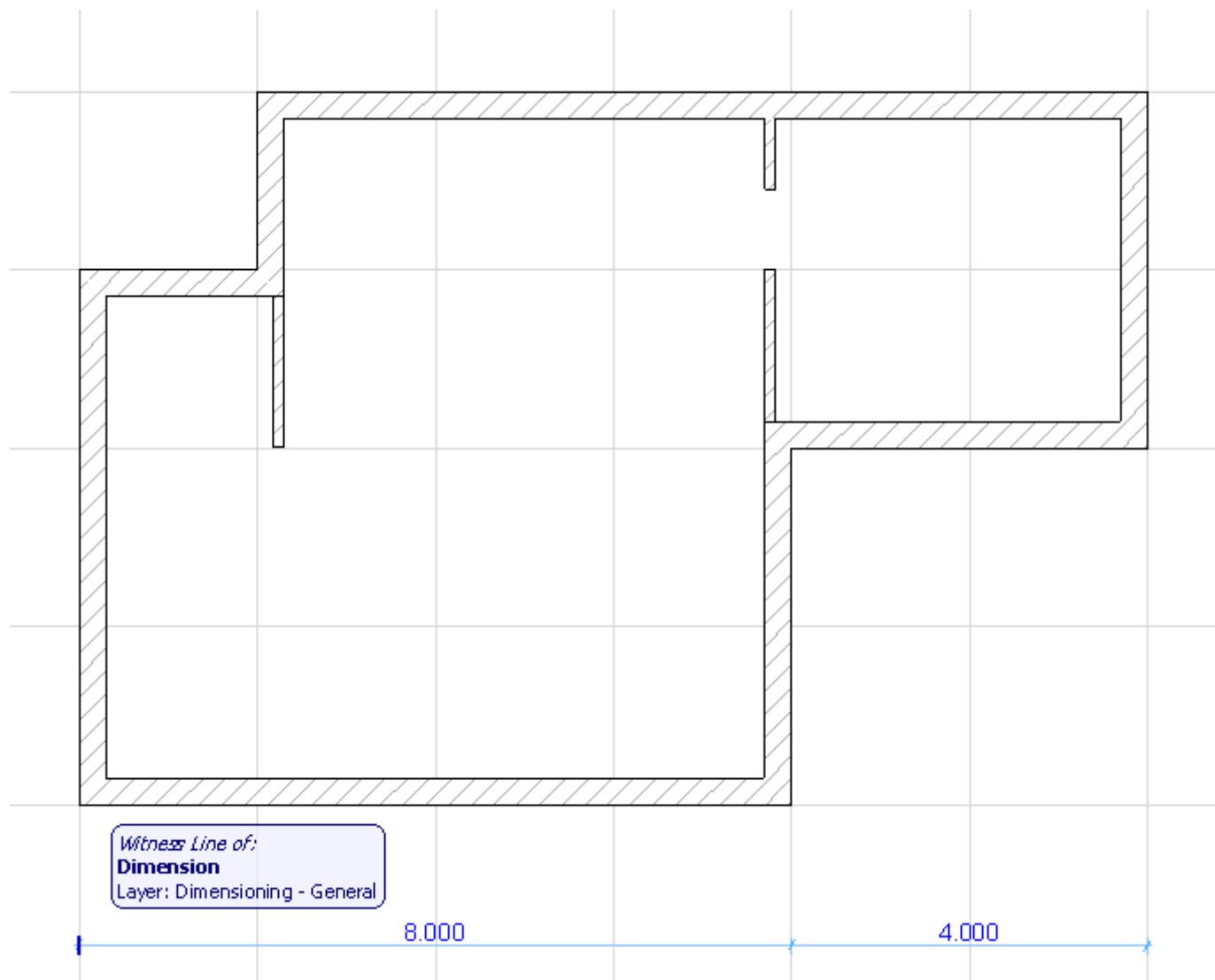

Димензионисање

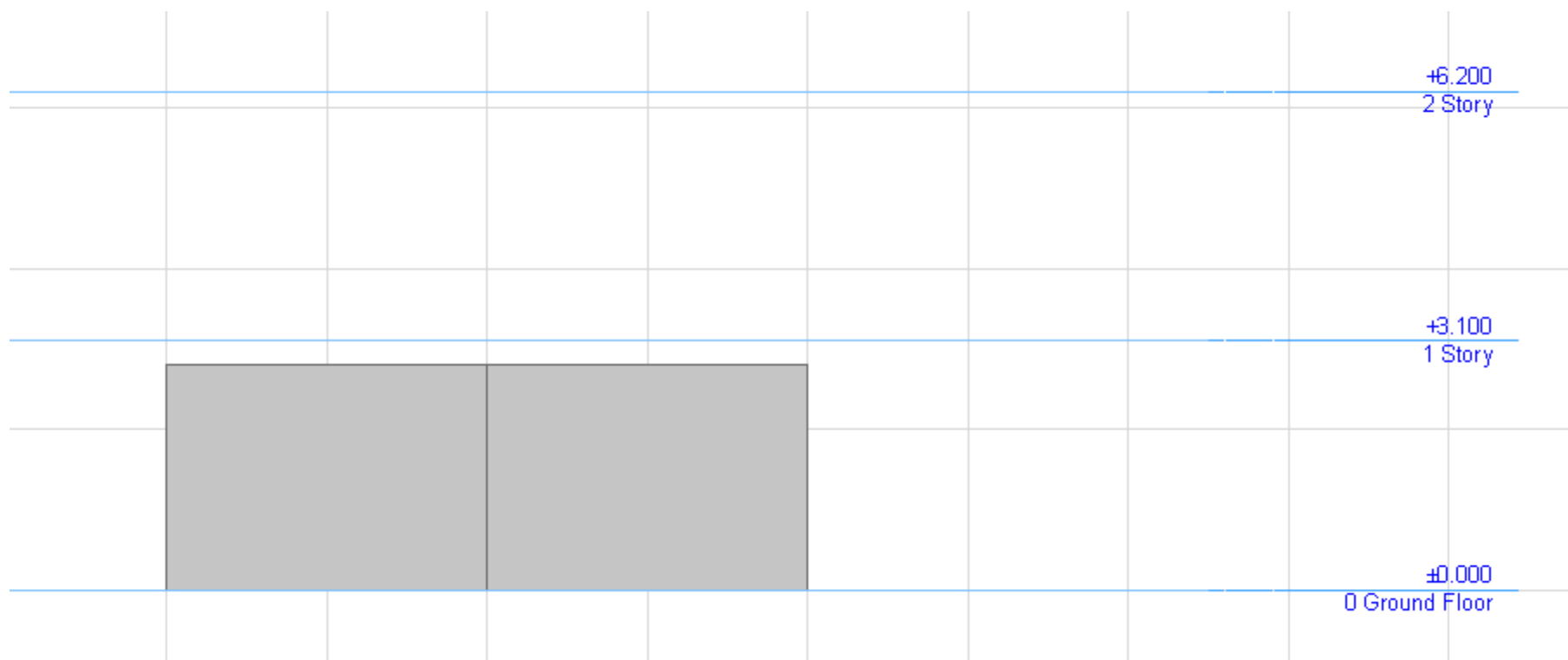
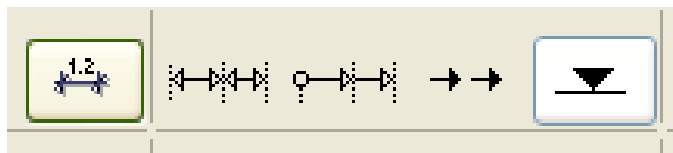

Димензионисање

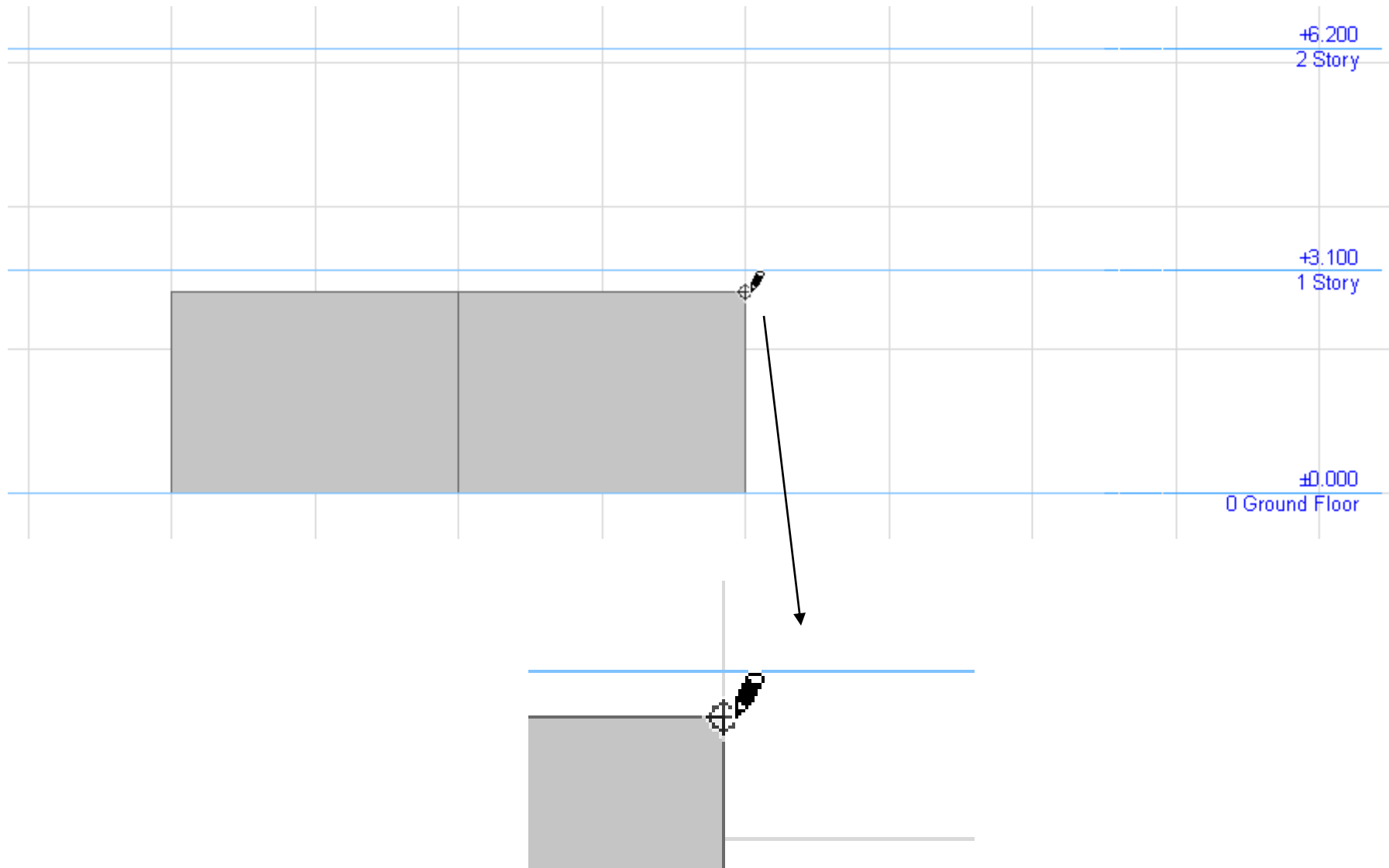

Димензионисање

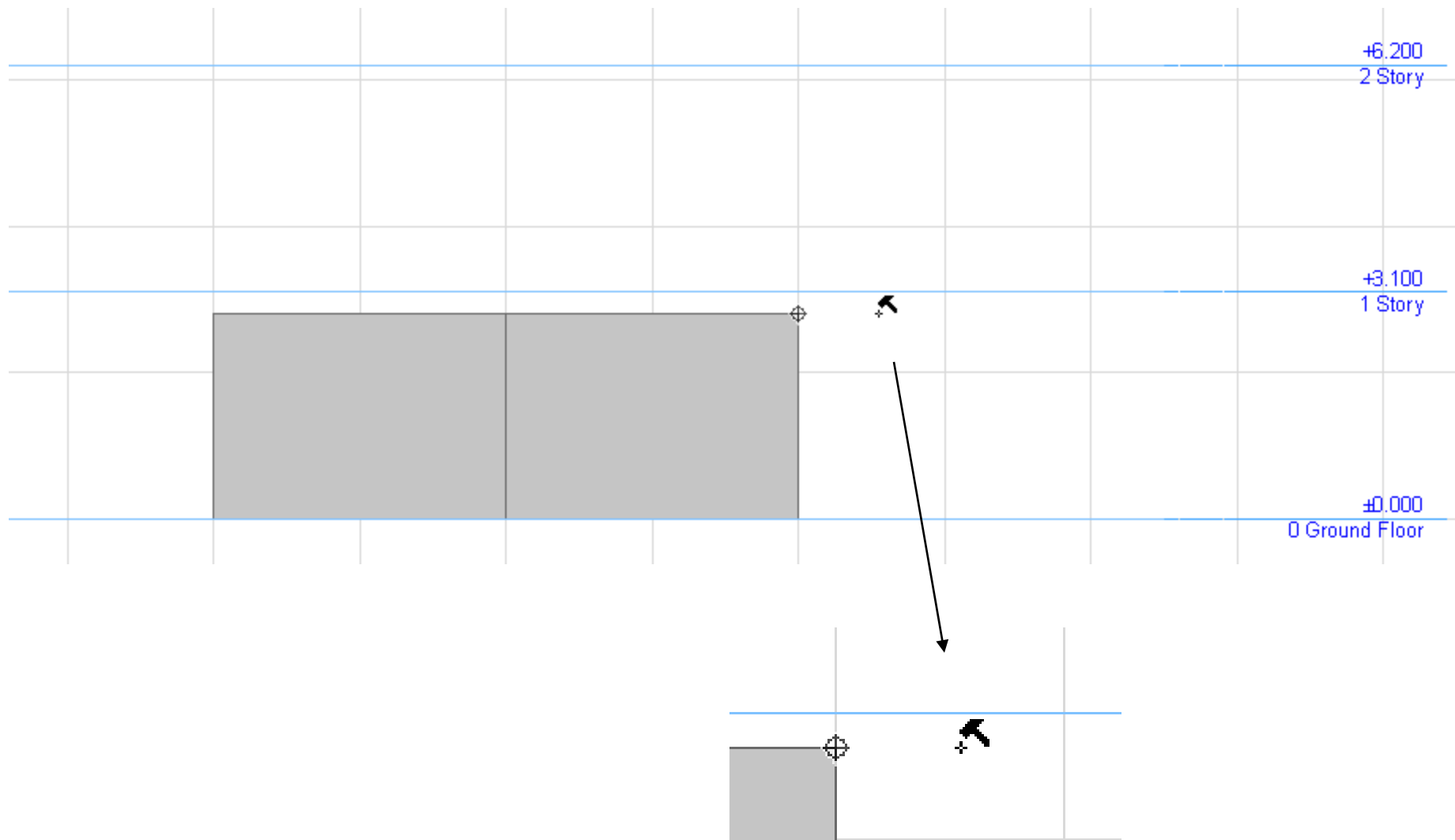

Димензионисање

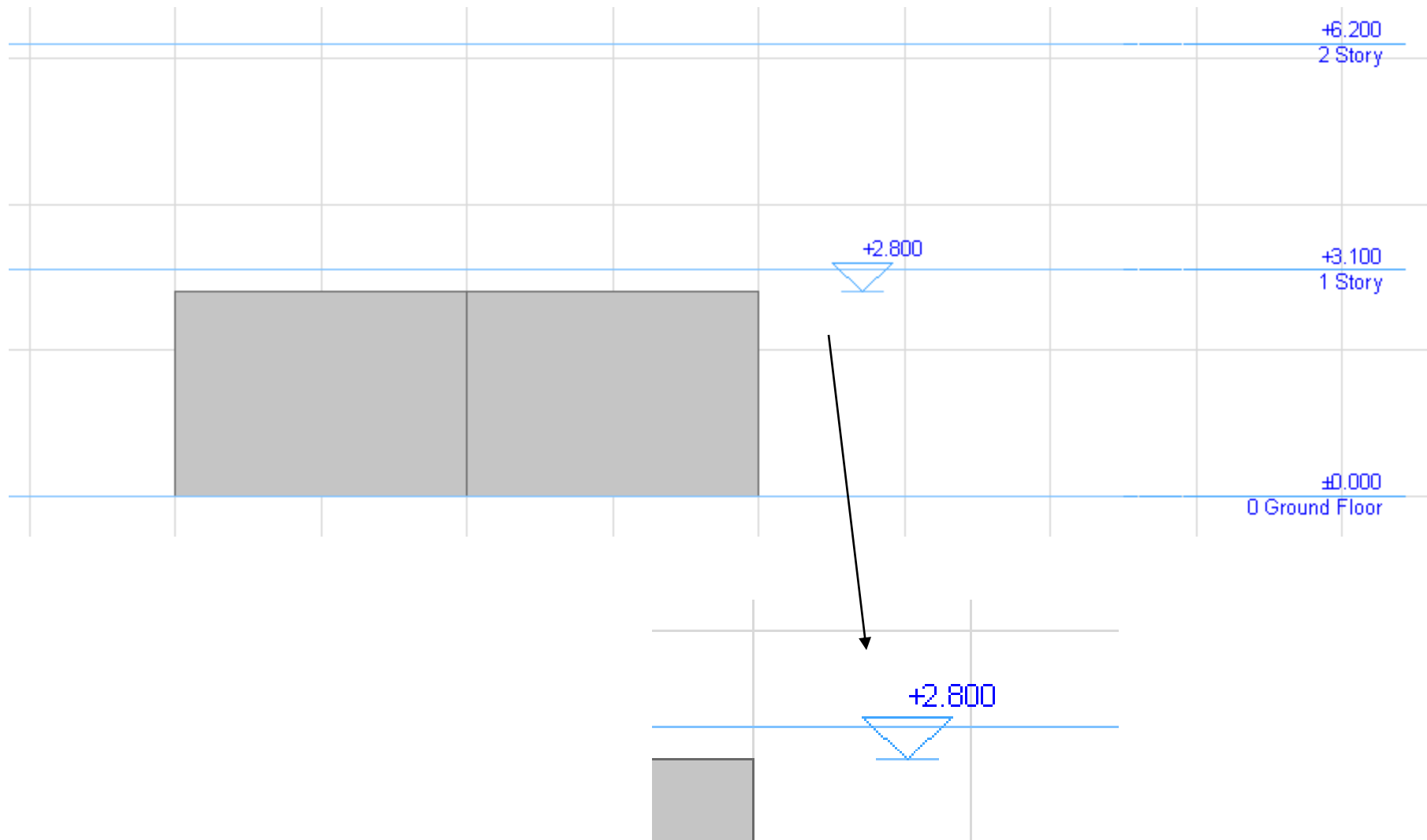

Димензионисање

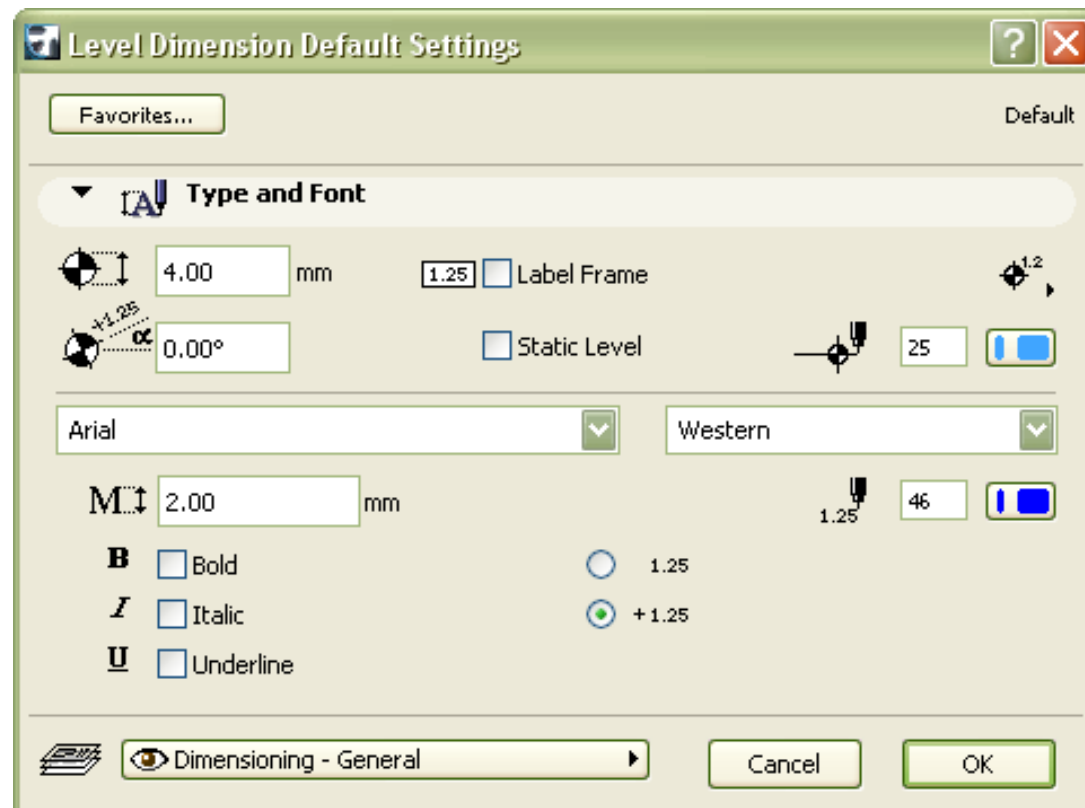
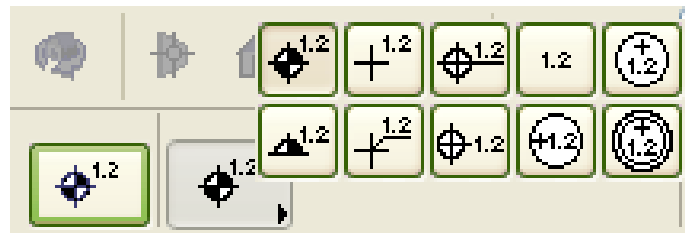
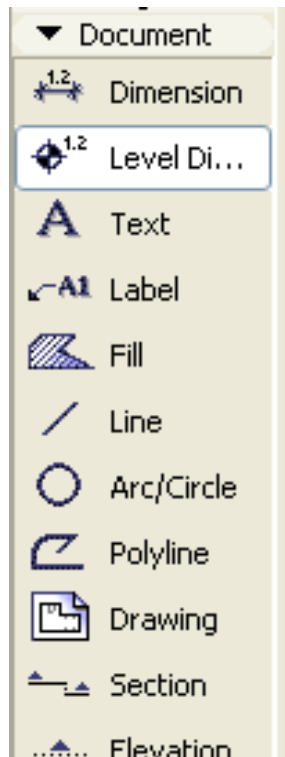

Димензионисање

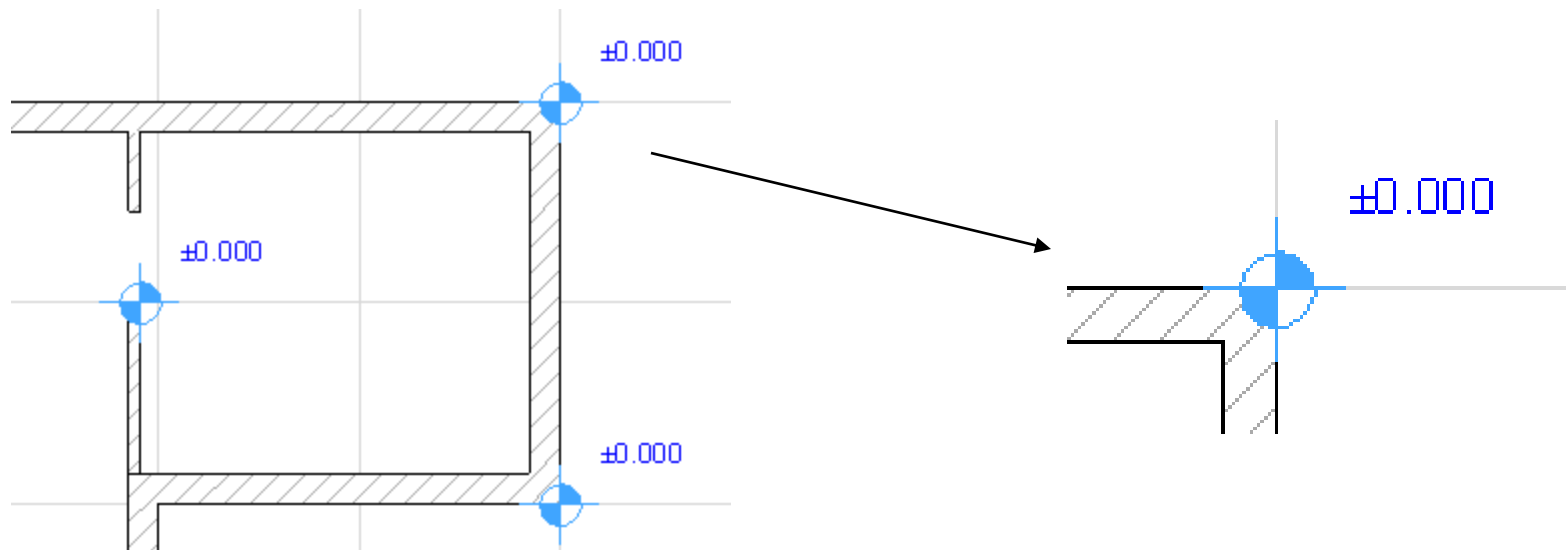
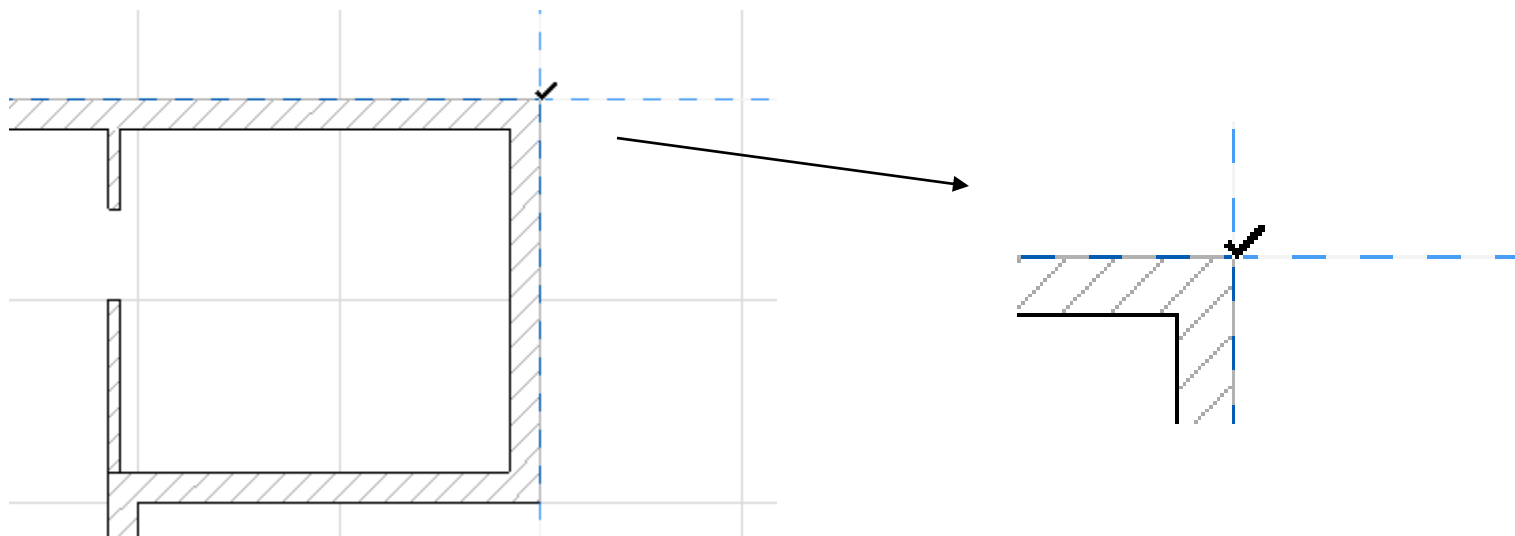

ДИМЕНЗИОНИСАЊЕ

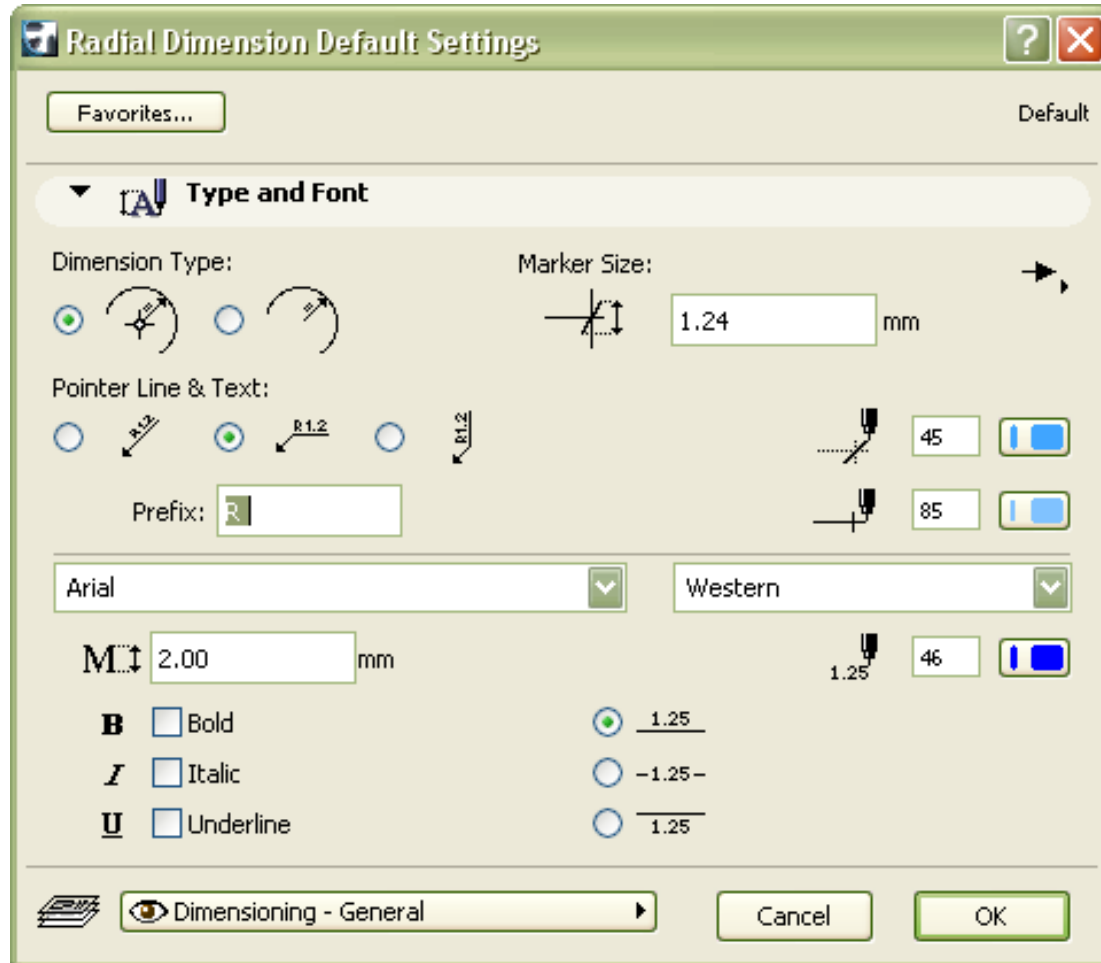

Димензионисање

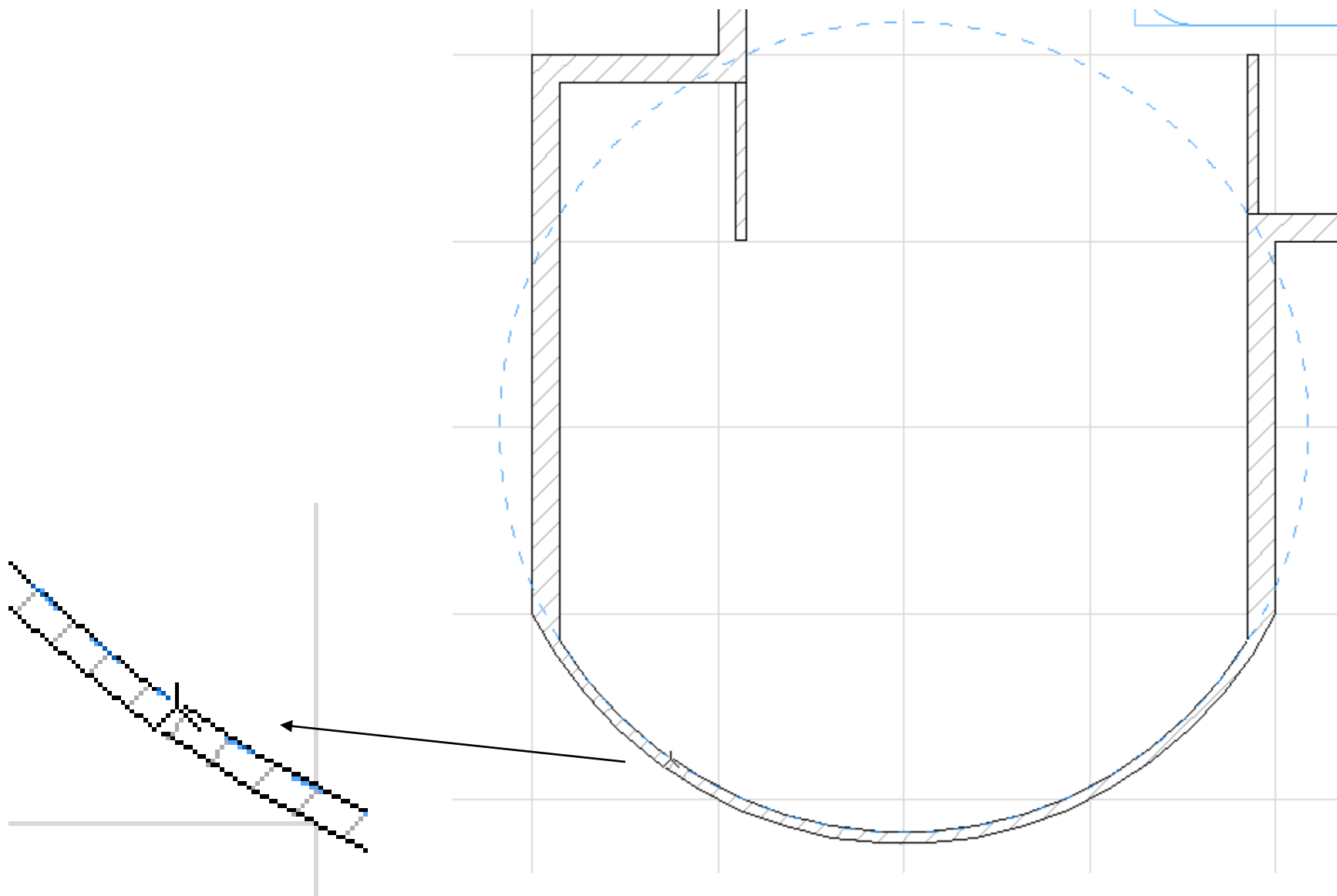

Димензионисање

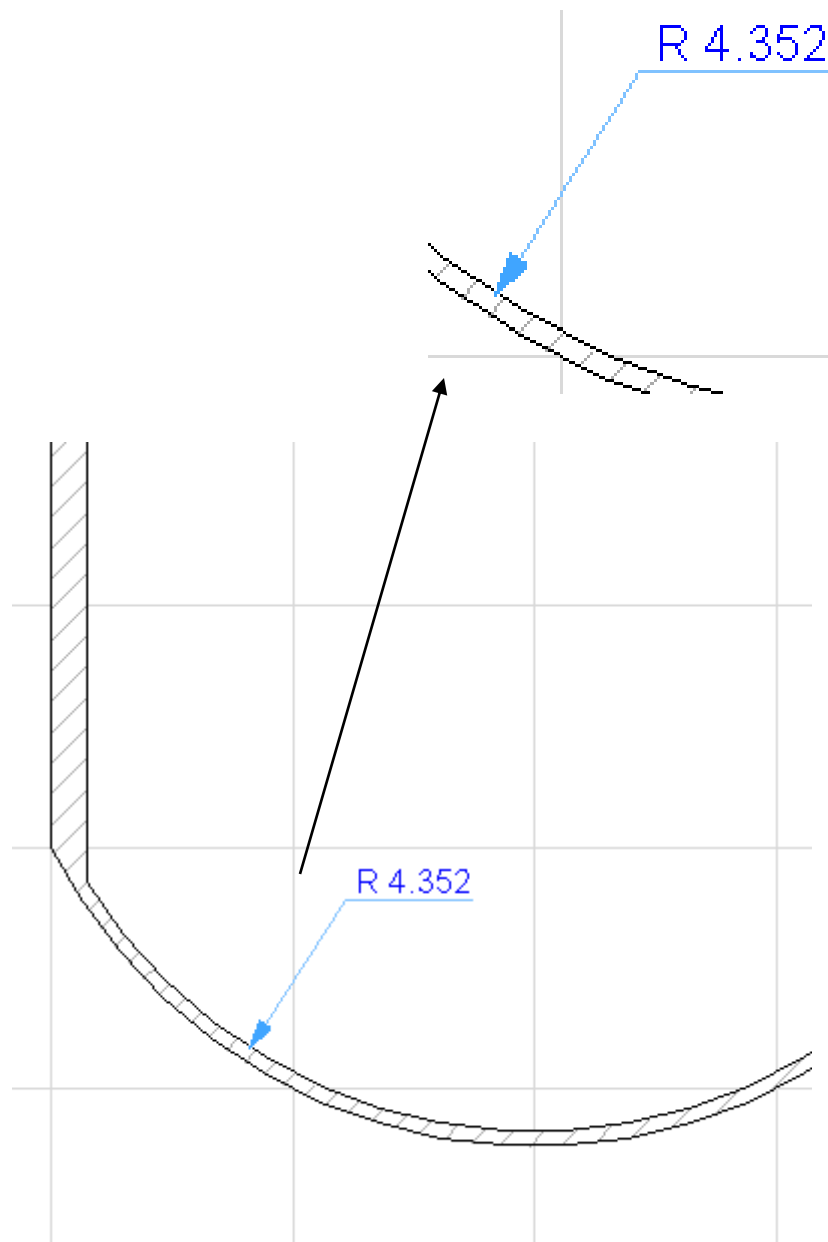
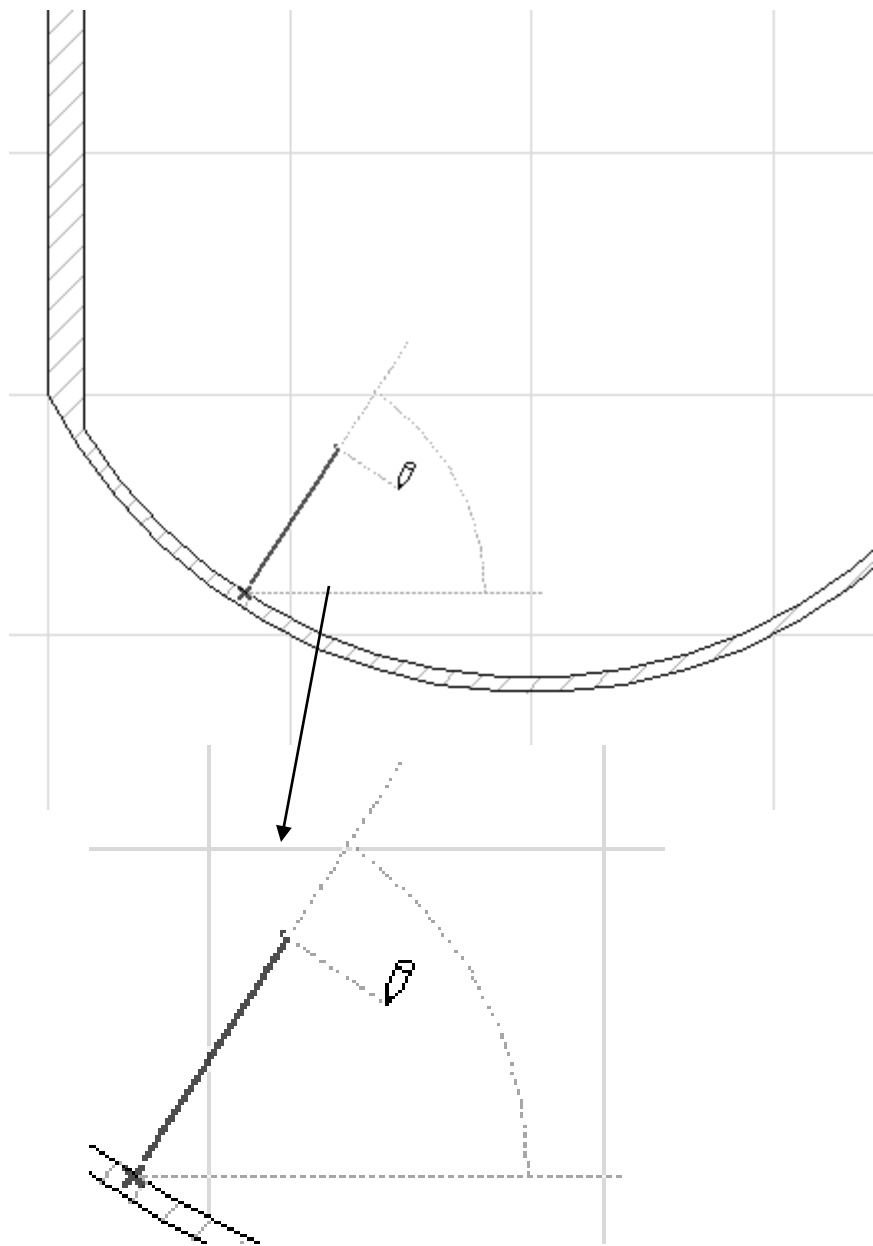

Димензионисање

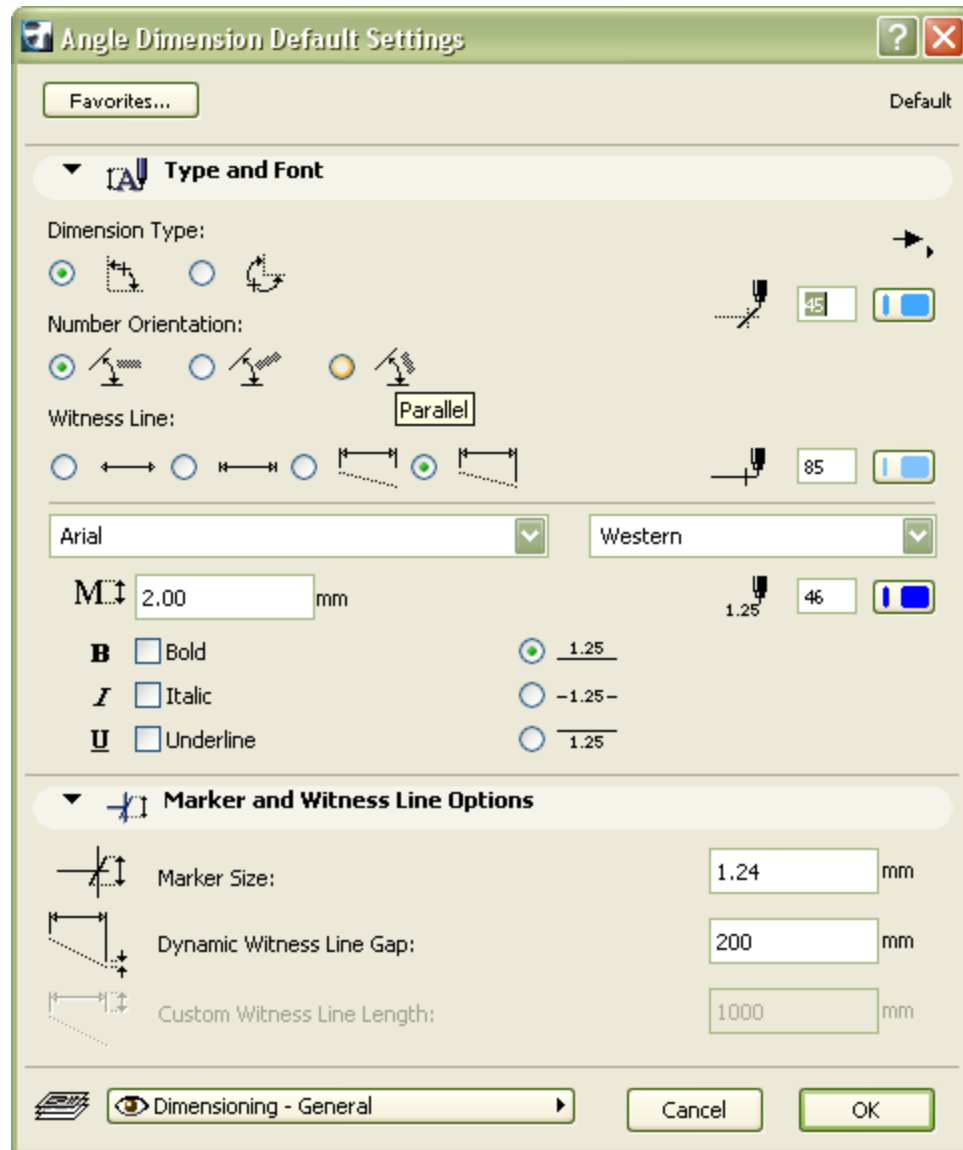

Димензионисање

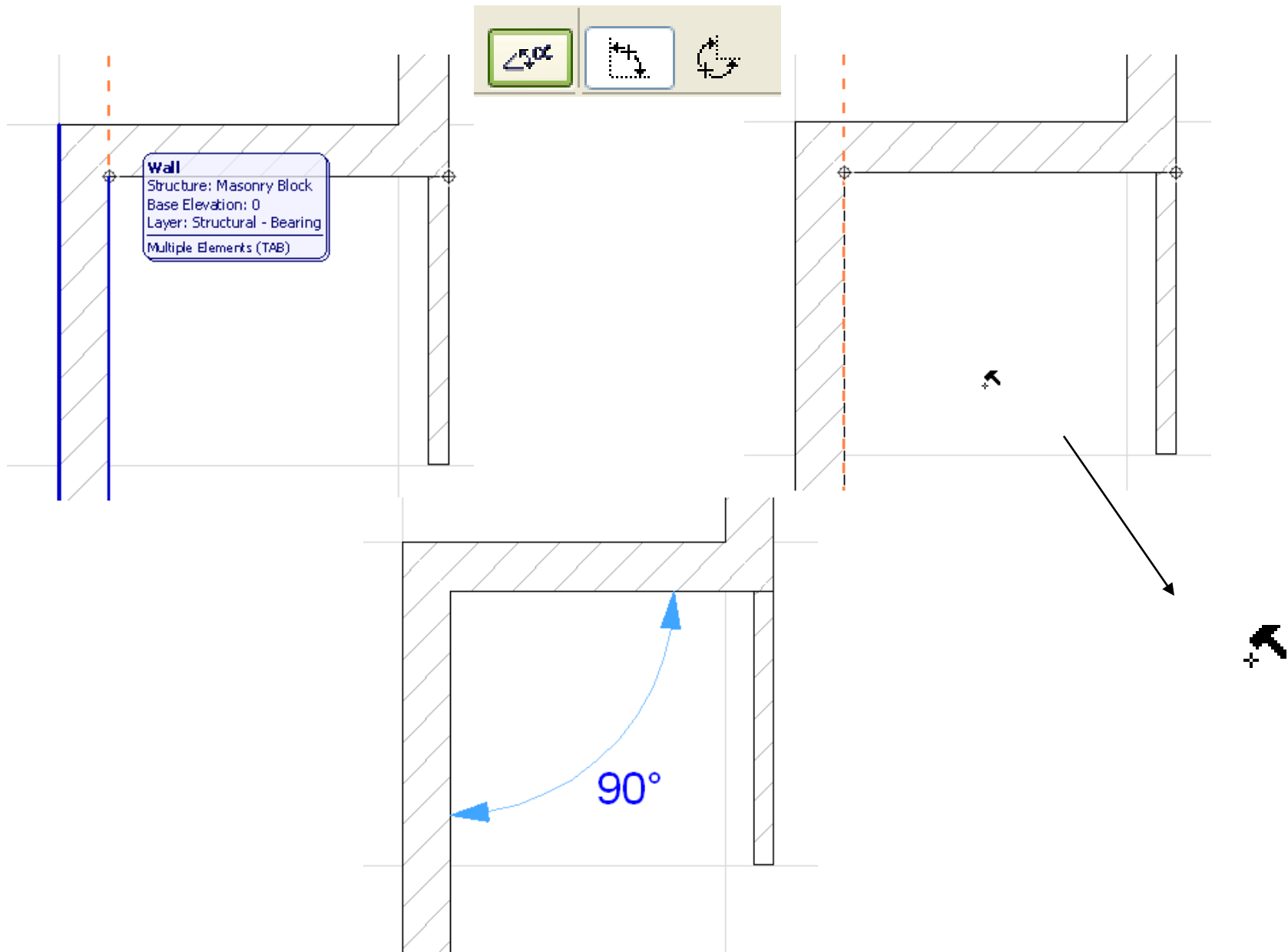

Димензионисање

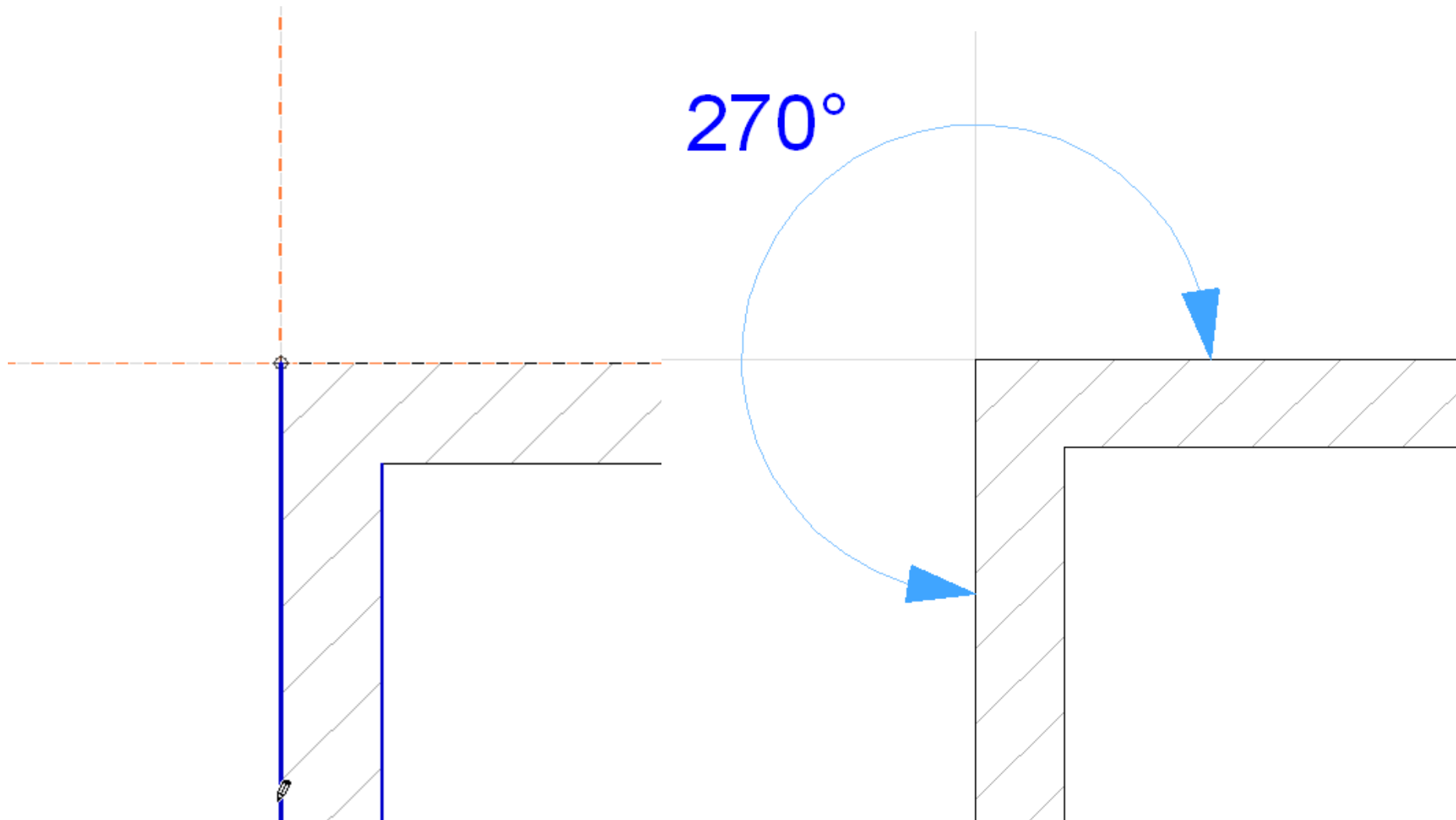

Текст

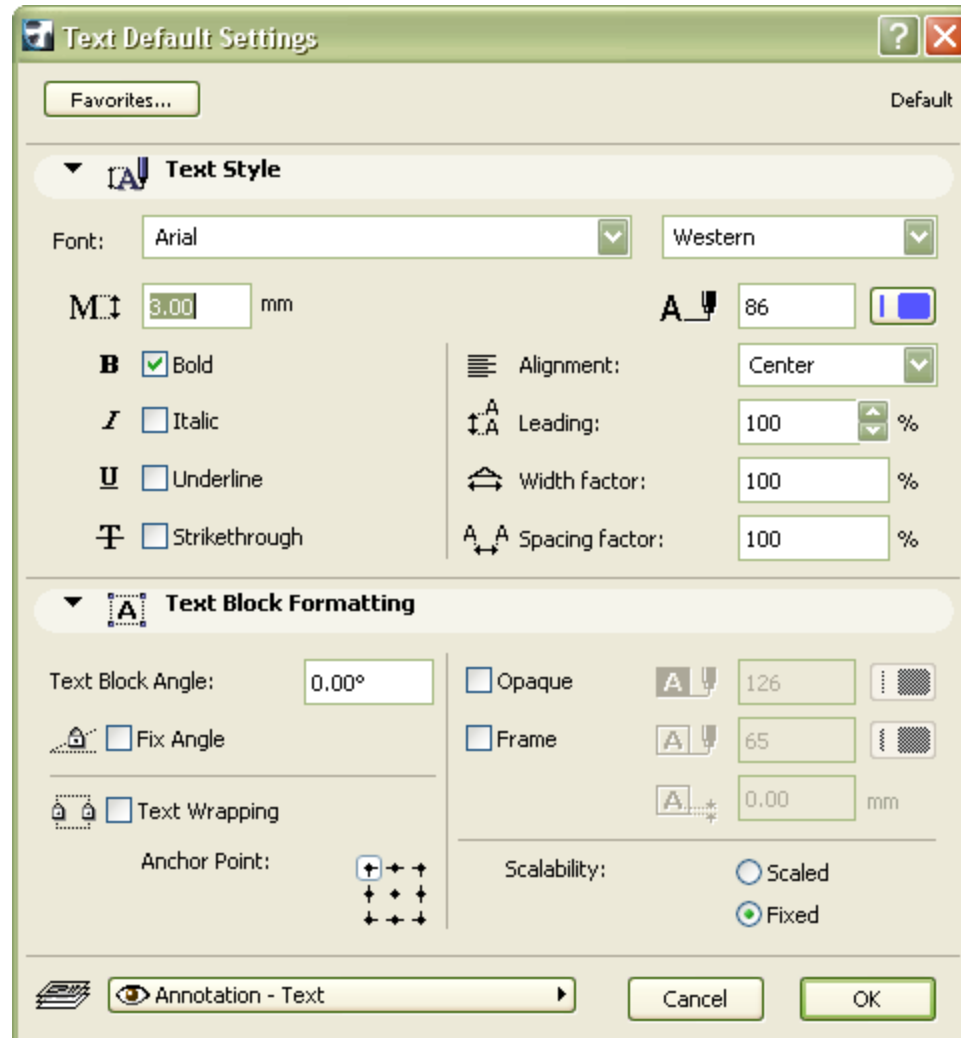
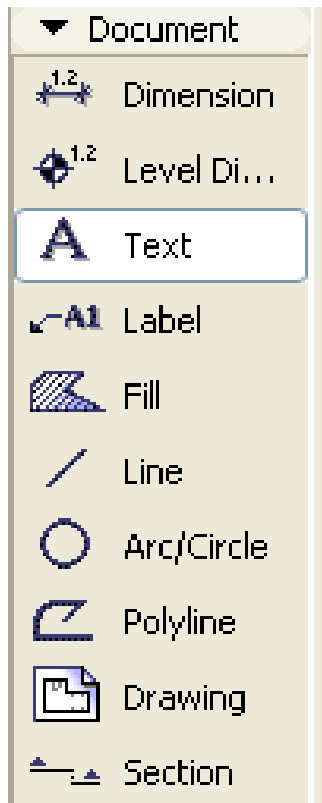

Текст

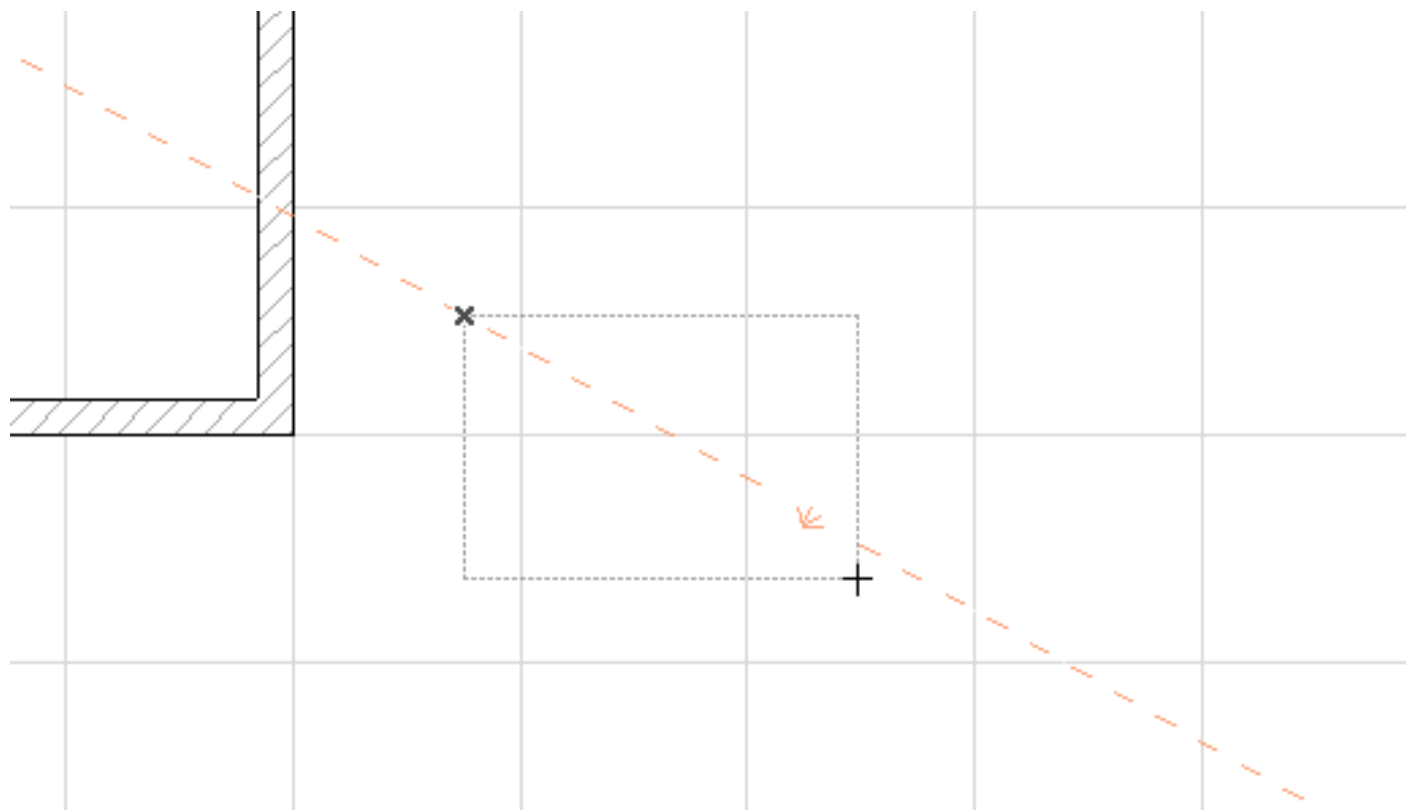

Текст

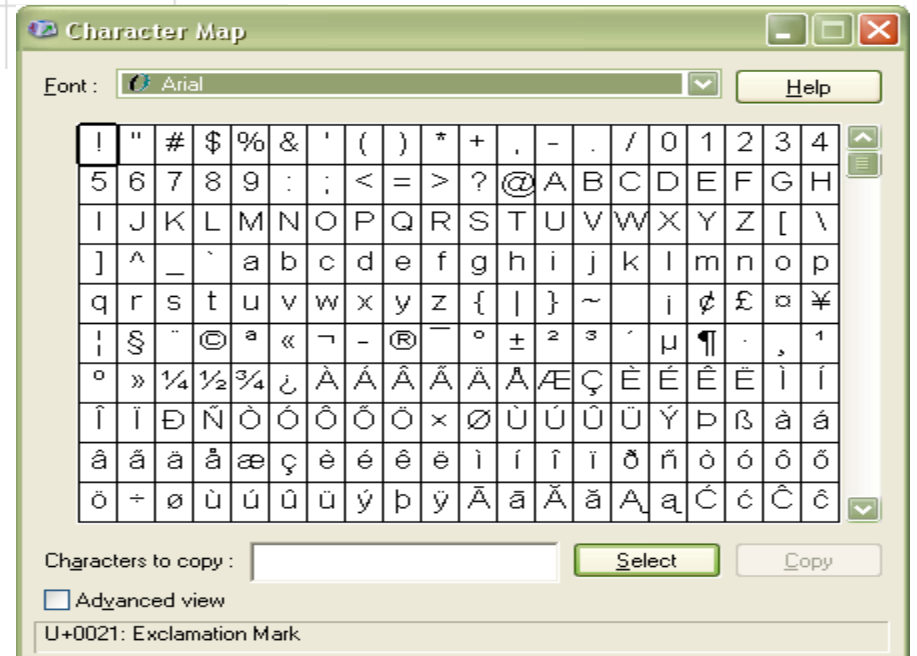
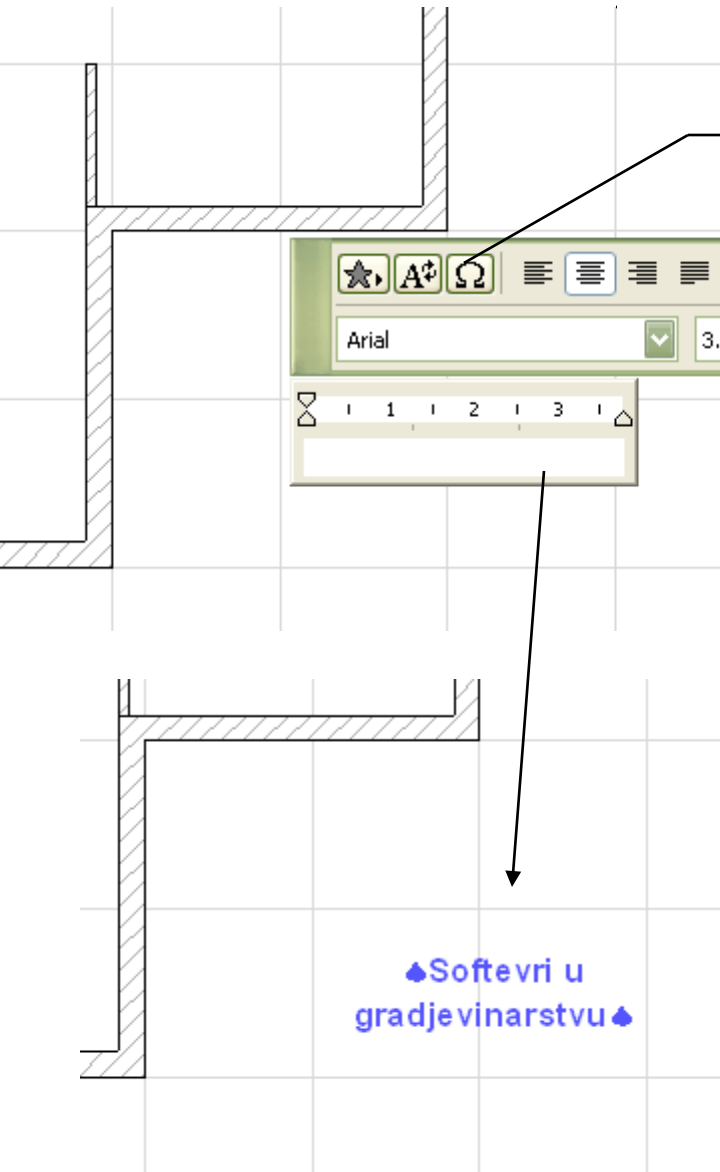

Деталѝ

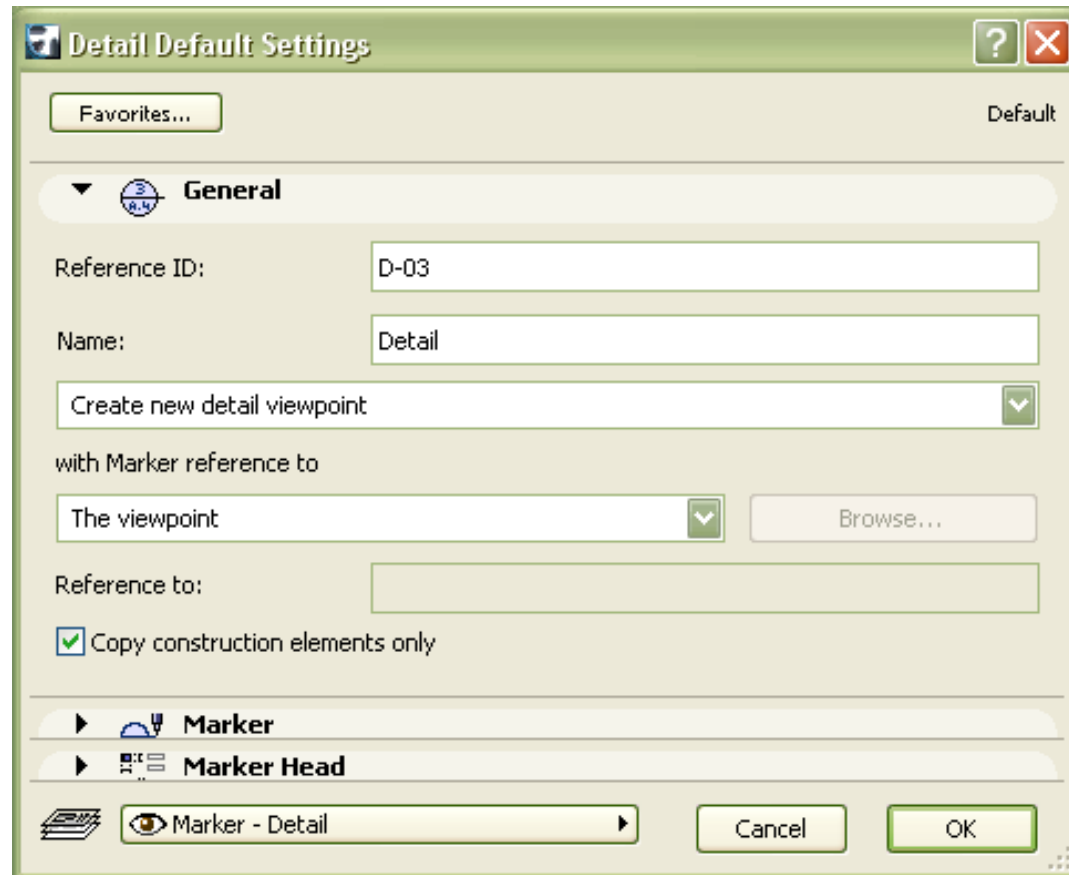
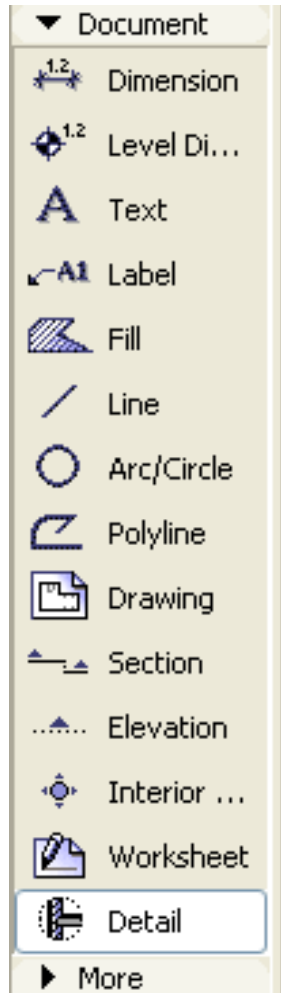

Деталји

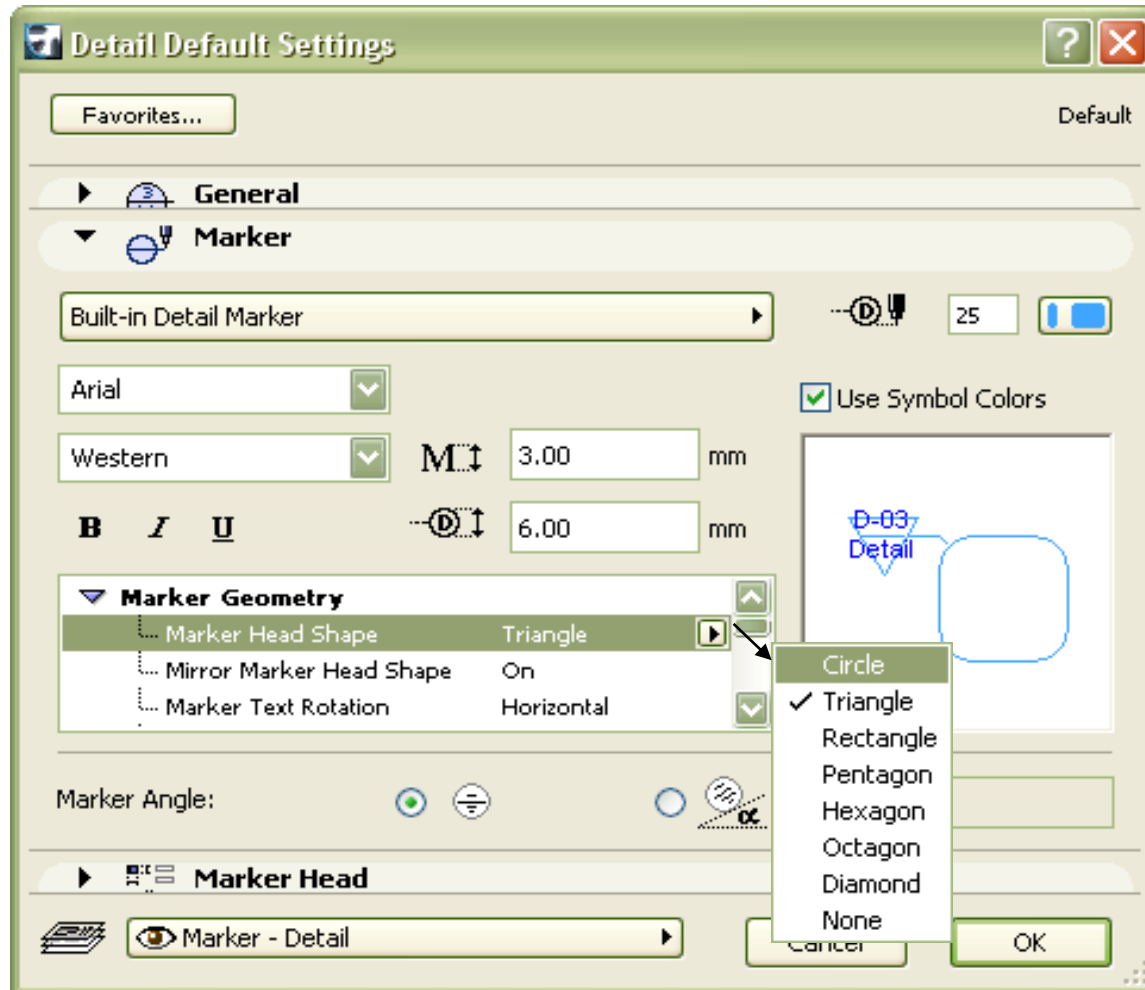

Деталји

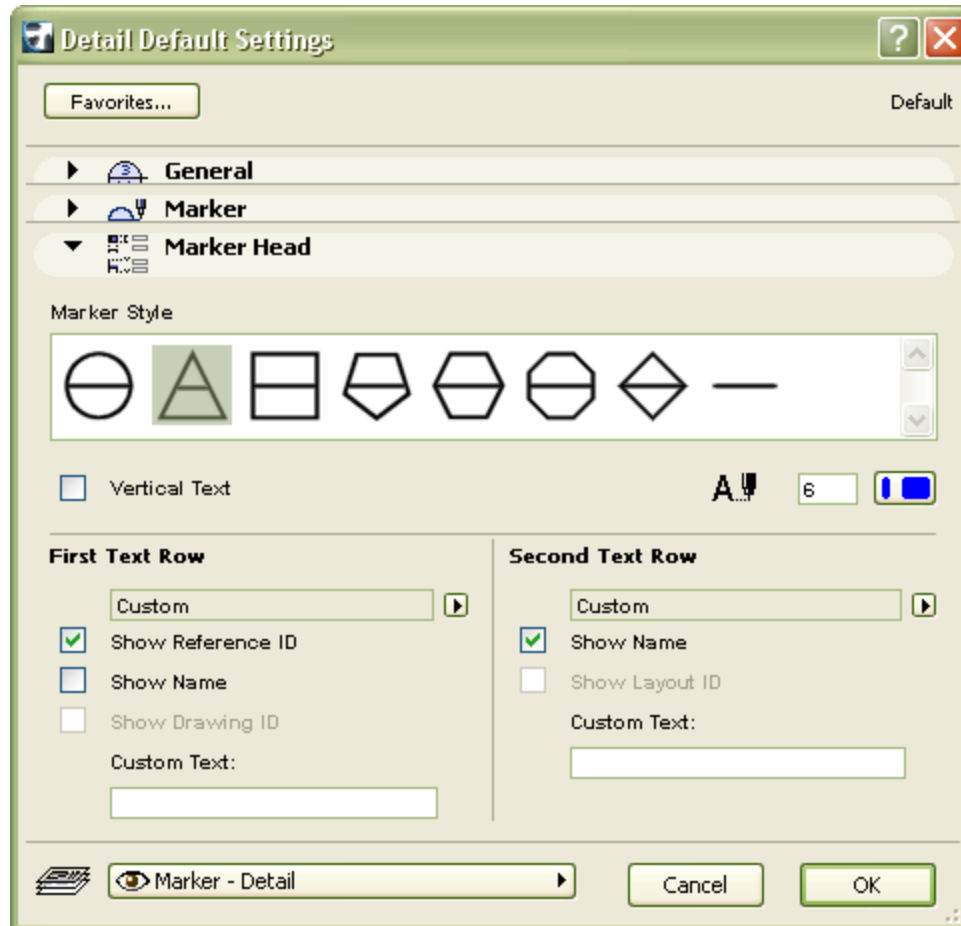

Деталѝ

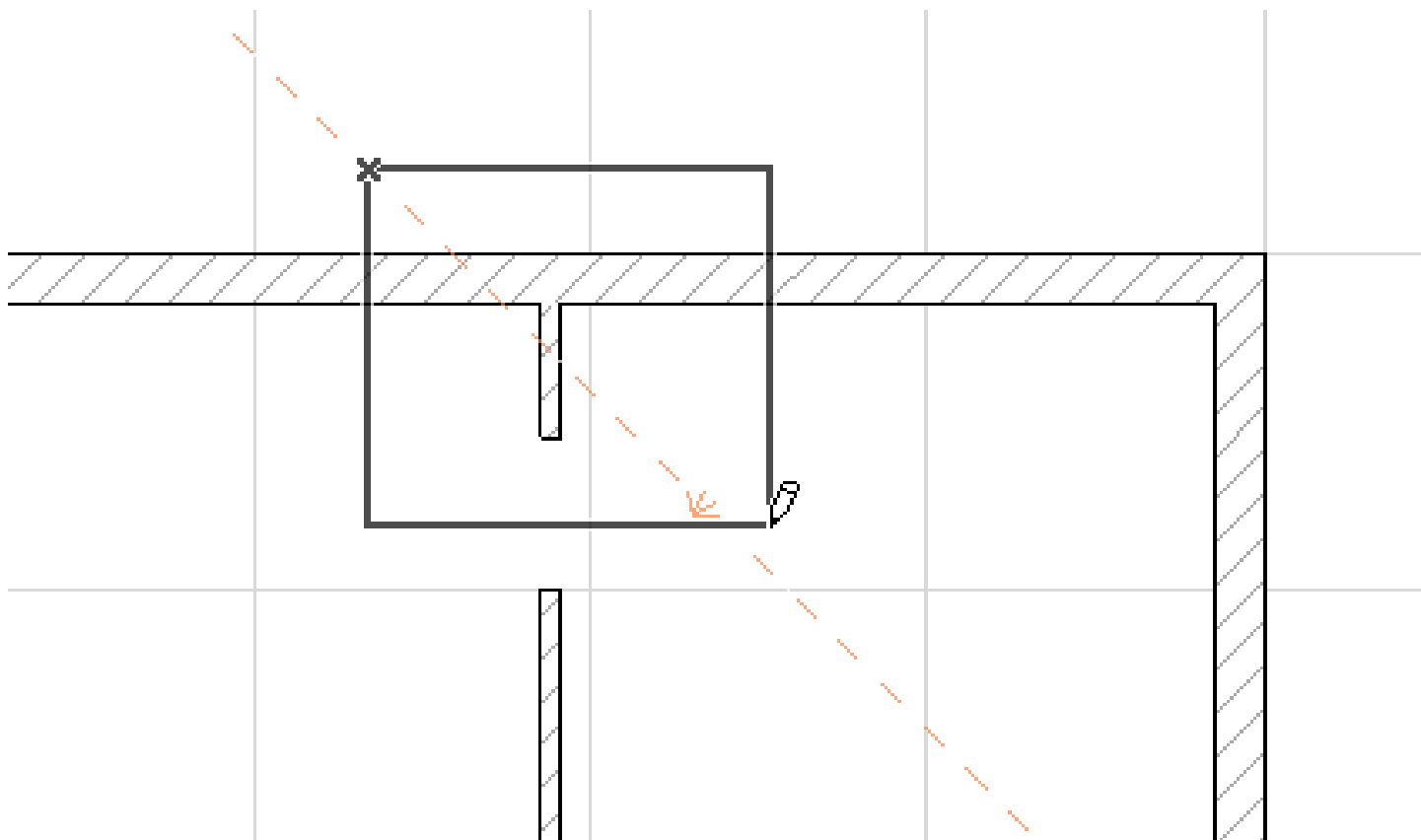

Деталѝ

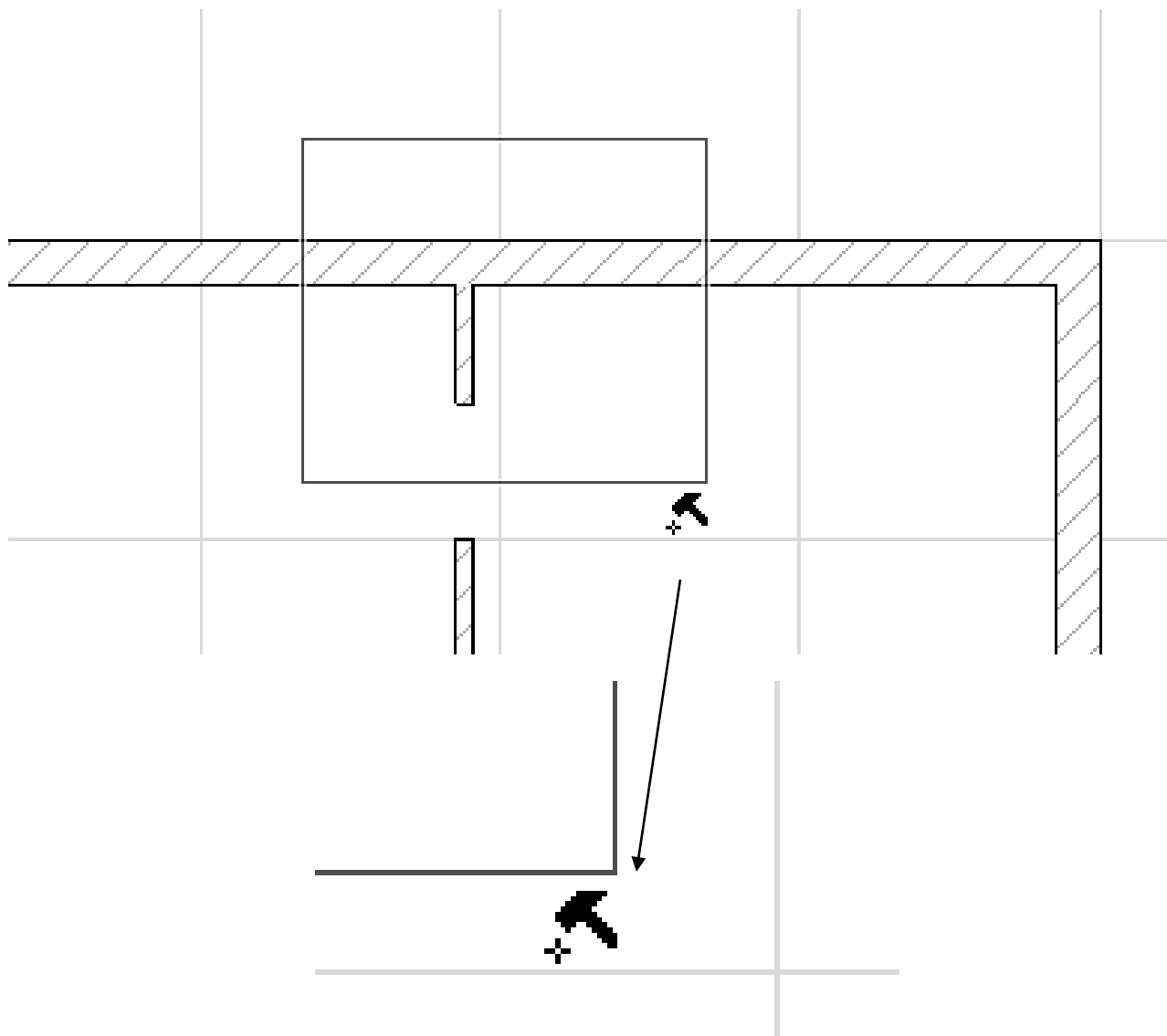

Деталѝ

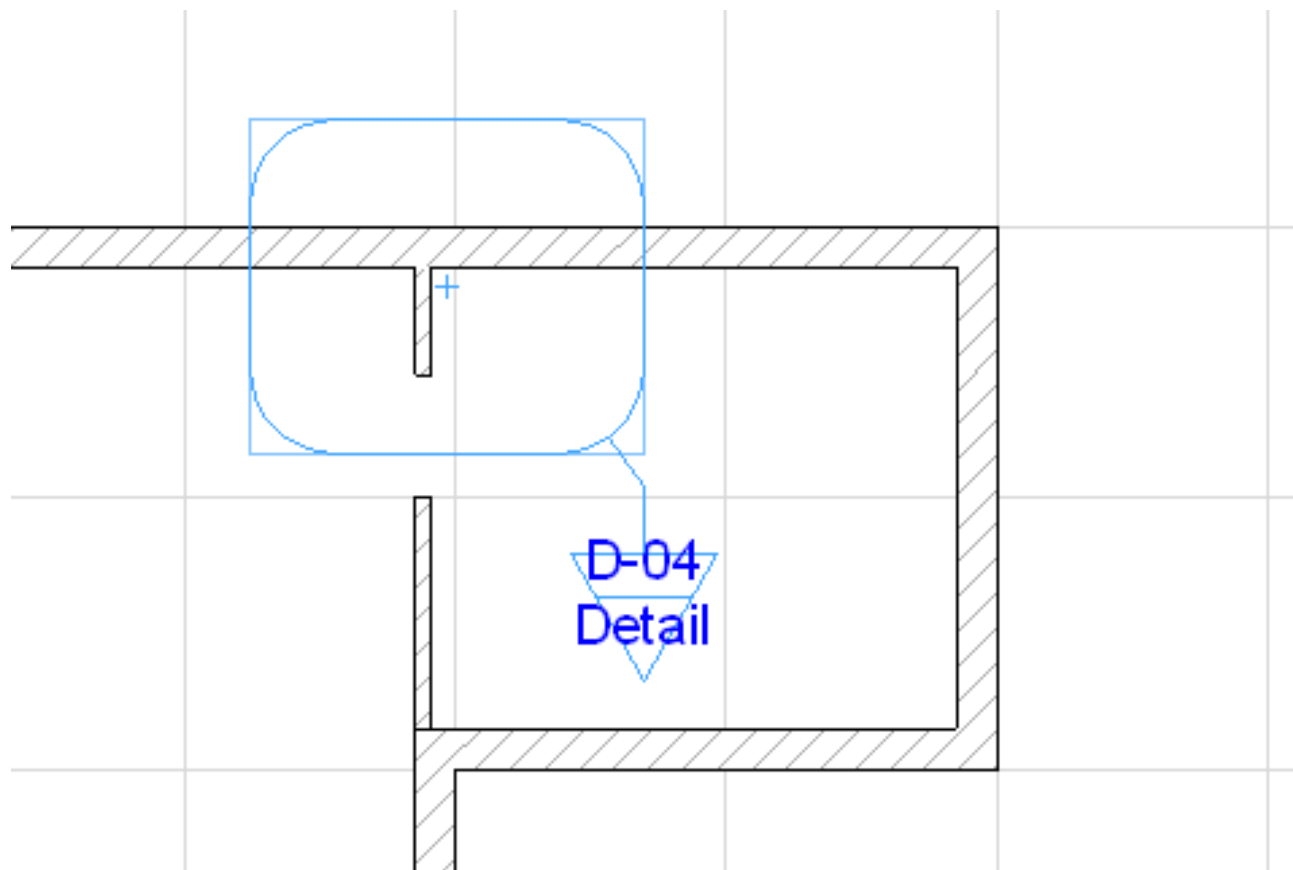

Деталји

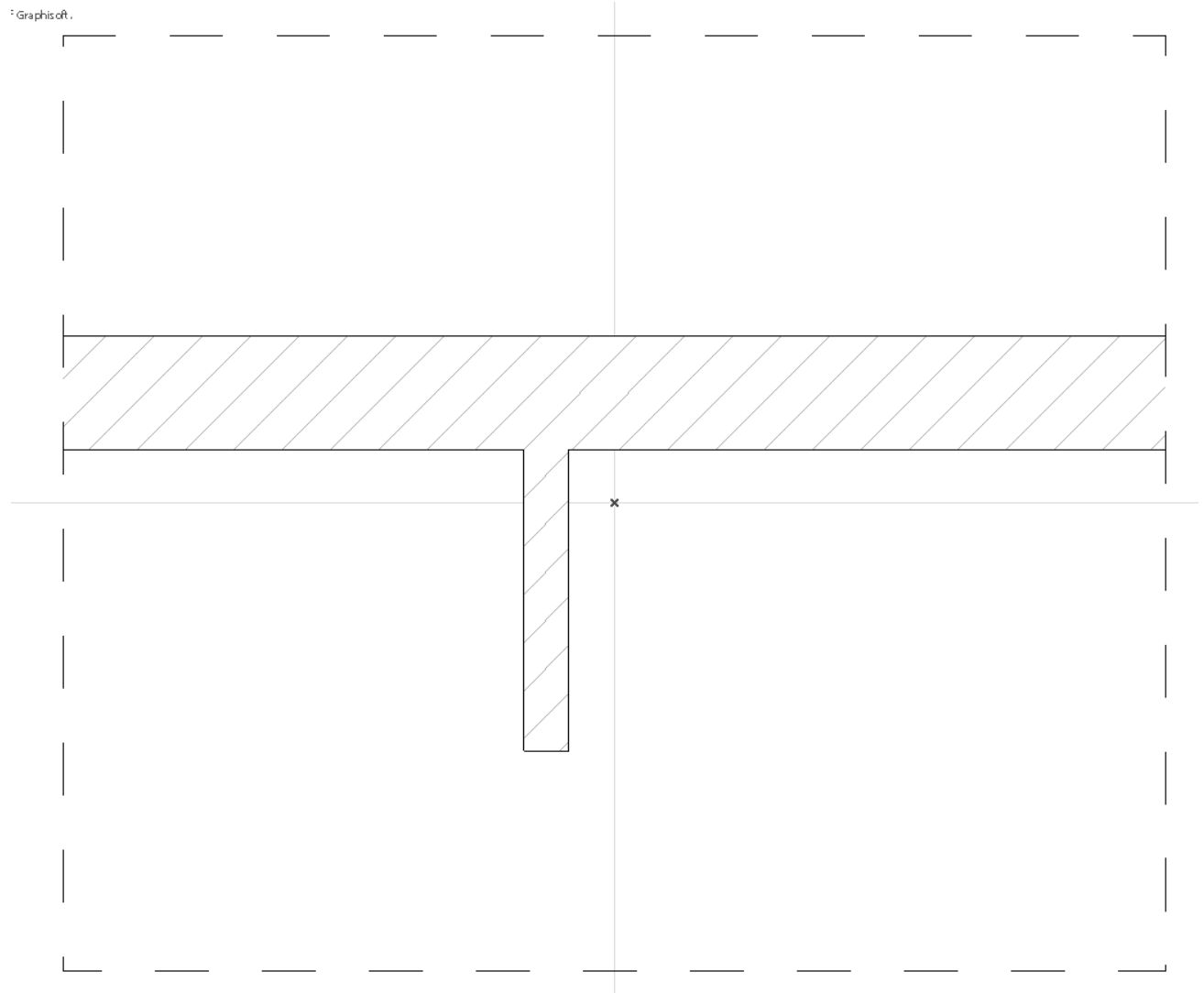
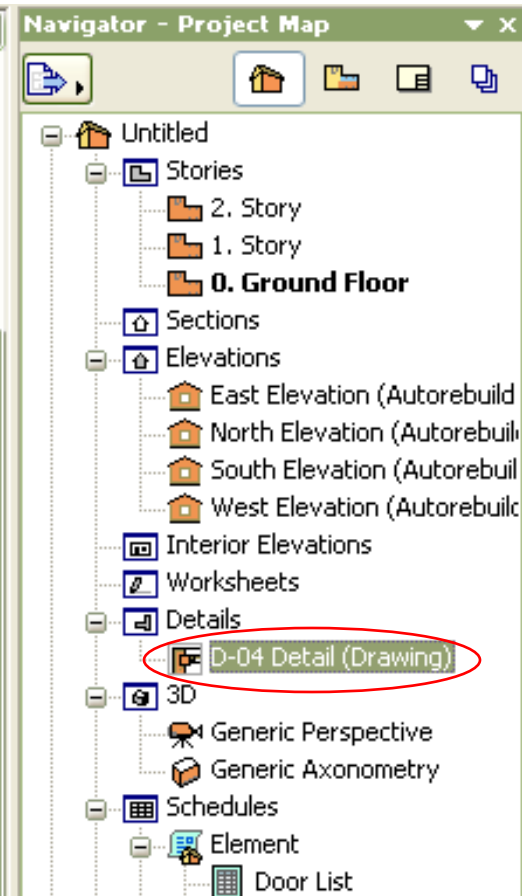

Слика

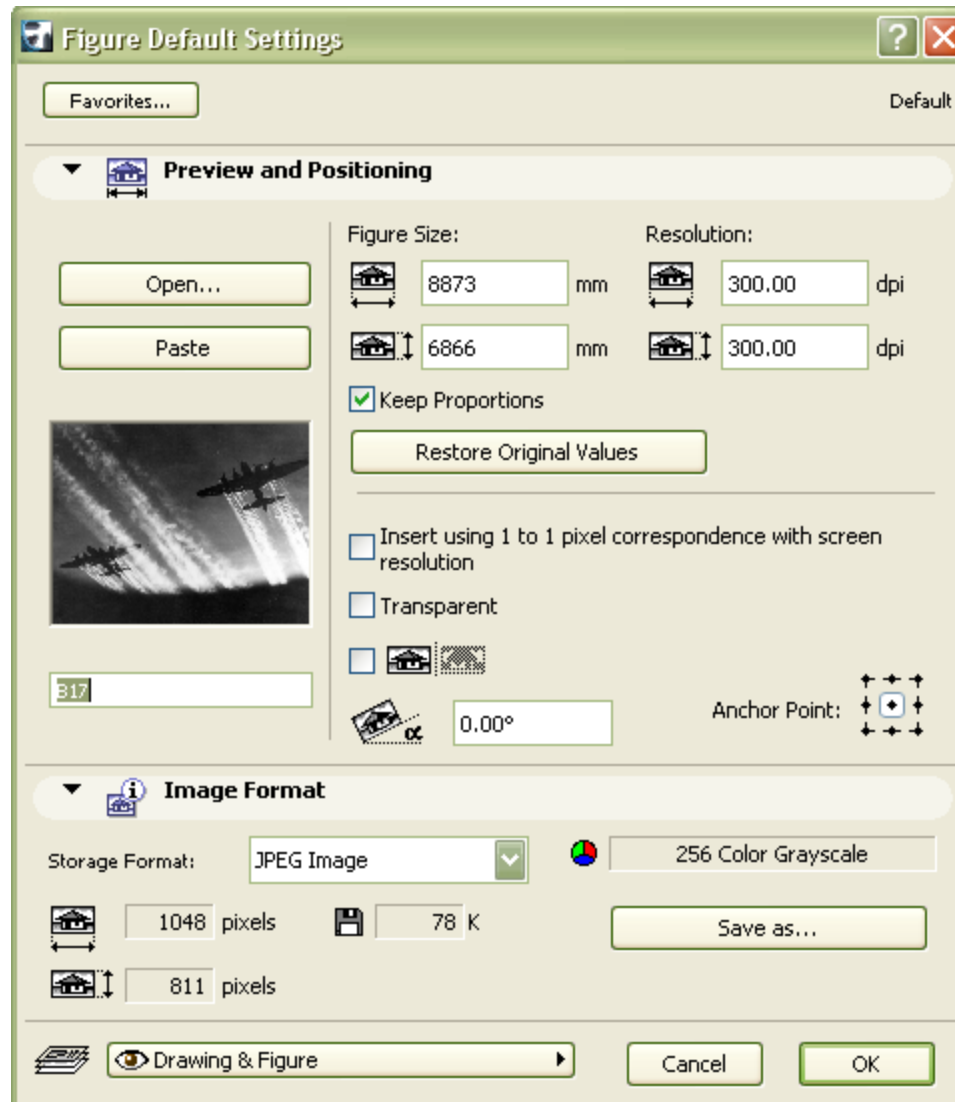

Слика

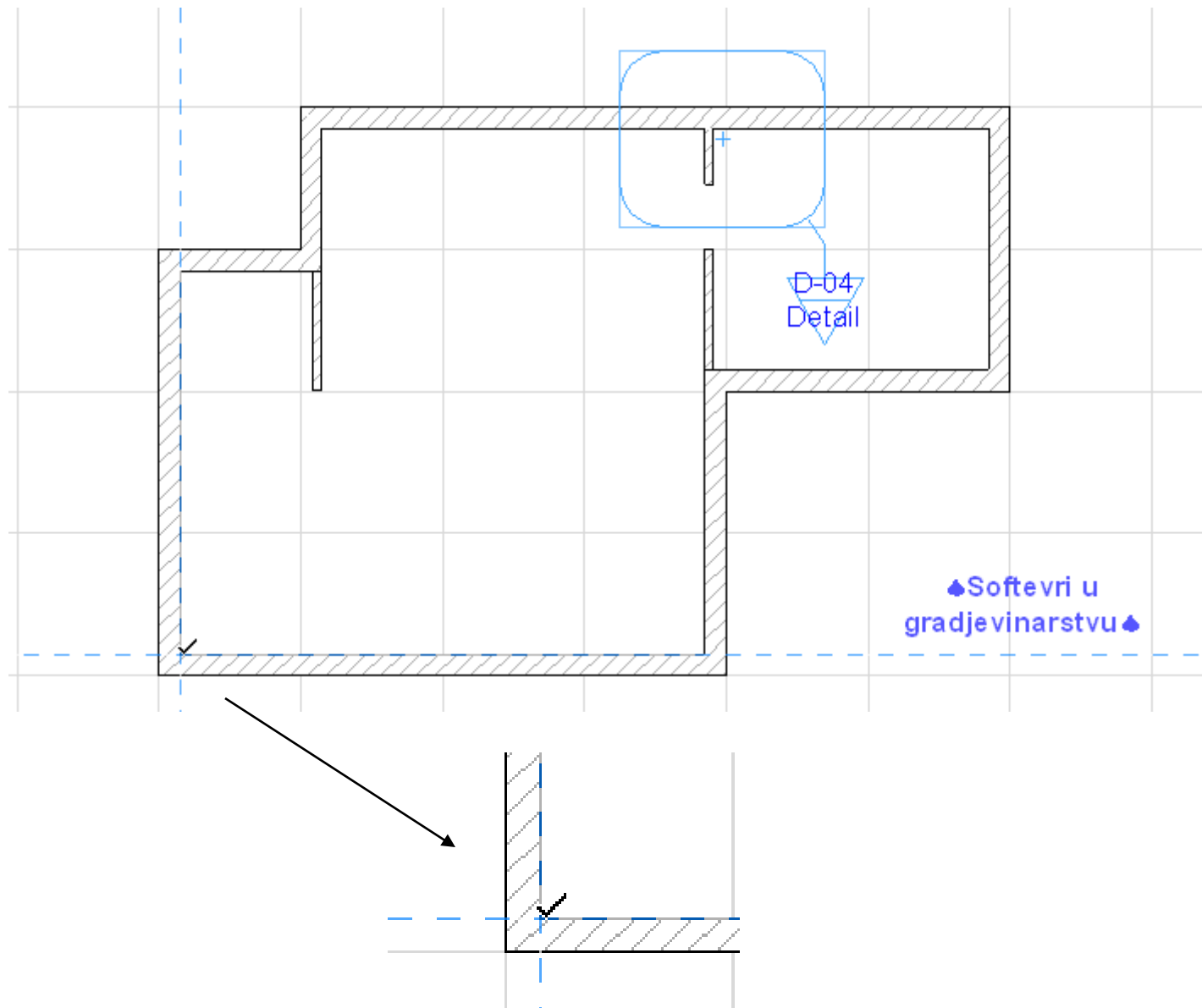

Слика

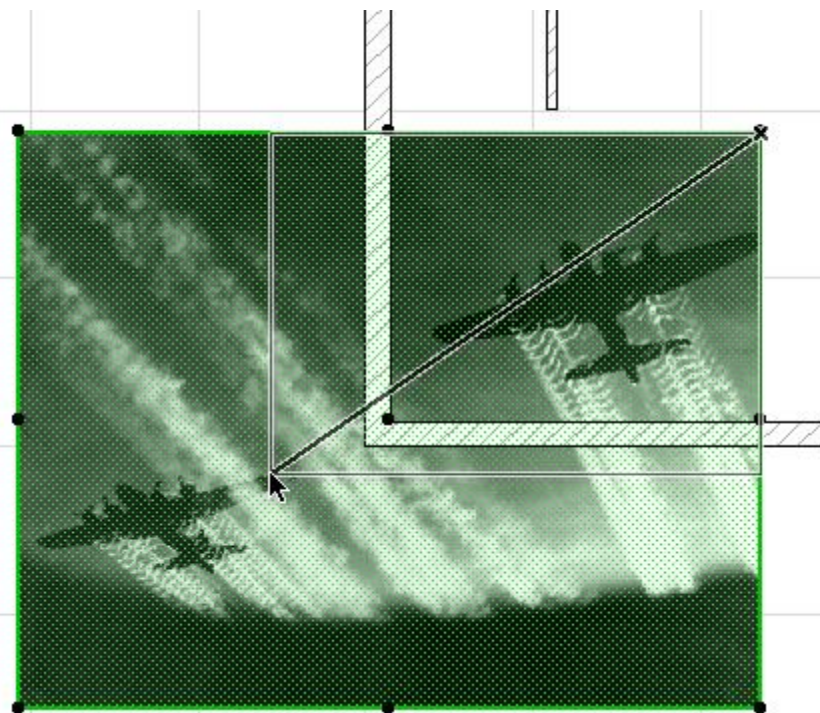
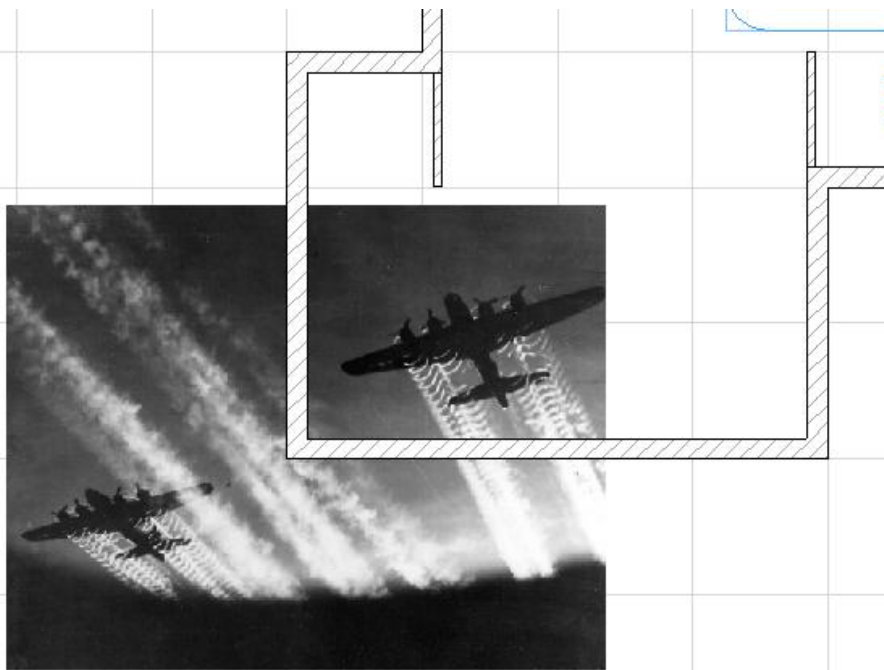

Зоне - просторије



Zone Default Settings [?] [X] Default

Favorites...

Name and Positioning

Zone Category: 2 Office

Zone Name: Office No: 001

Zone Height: 2700

Zone Level: 0

Subfloor Thickness: 0

Zone Polygon:
 Gross Net

Zone Stamp Angle:
0.00°
 Fix Angle

Floor Plan

Zone Stamp

Custom Settings

Model

Area Calculation

Listing and Labeling

Model Unit - Zone

Cancel OK

Зоне - просторије

Zone Default Settings [?] [X] Default

Favorites... [Default]

▶ **Name and Positioning**

▼ **Floor Plan**

 Solid Line [74] [On]

 Circles 2 [94] [On] [134] [Off]

Link to Project Origin Use Fill of surface Material
 Link To Fill Origin

▼ **Zone Stamp**

Zone_Stamp_02 11 [6] [On]

Arial [M] 3.00 mm Use Symbol Colors
Western

Midpoint Hotspots	On
Font Size for Details	3.00
Details Justification	Centered
▶ Show Frame	On
▶ Show Zone Name	On
▶ Show Zone No.	On

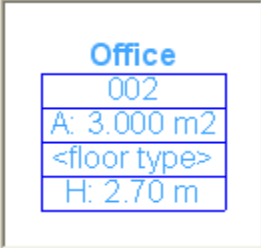

▶ **Custom Settings**

▶ **Model**

▶ **Area Calculation**

▶ **Listing and Labeling**

 Model Unit - Zone [Cancel] [OK]

Зоне - просторије

Zone Default Settings [?] [X] Default

Favorites... [Default]



▶ **Name and Positioning**

▶ **Floor Plan**

▶ **Zone Stamp**

▶ **Custom Settings**

▼ **Model**

 **Brick-Common Bond**  [X] ▶

Use this Material on All Zone Surfaces
 Inherit Boundary Wall and Trimming Element Materials

Zone is Trimmed by one or more Elements. [Undo Top Trim] [Undo Bottom Trim]

▶ **Area Calculation**

▼ **Listing and Labeling**

ID:

Link Properties:
 By Criteria

Matching Properties:
Cannot display the list of Matching Prop... [Up] [Down]

Individually [Choose...]

 **Model Unit - Zone** ▶ [Cancel] [OK]

Зоне - просторије

Zone Default Settings [?] [X] Default

Favorites...

▶ **Name and Positioning**

▶ **Floor Plan**

▶ **Zone Stamp**

▶ **Custom Settings**

▶ **Model**

▼ **Area Calculation**

Measured Net Area:

Area Subtraction:

-

-

-

-

Remaining Area:

Reduce by %

Calculated Area:

Any changes will take effect if zones are updated.

Measured Gross Area:

▶ **Listing and Labeling**

Model Unit - Zone

Cancel OK

Зоне - просторије

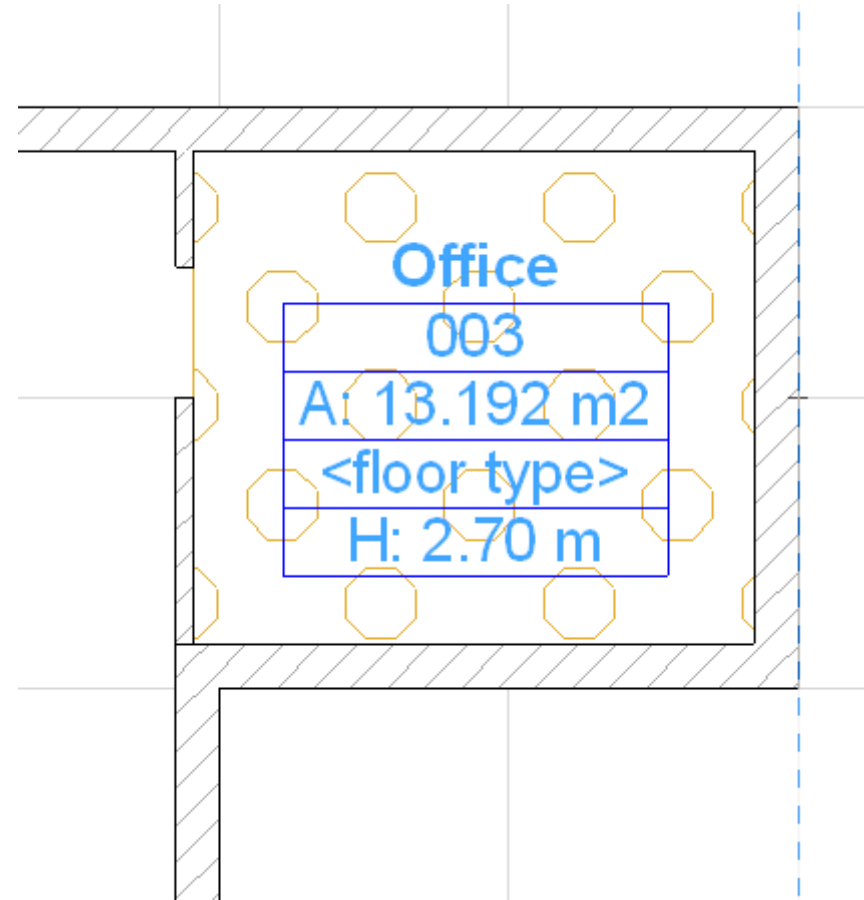
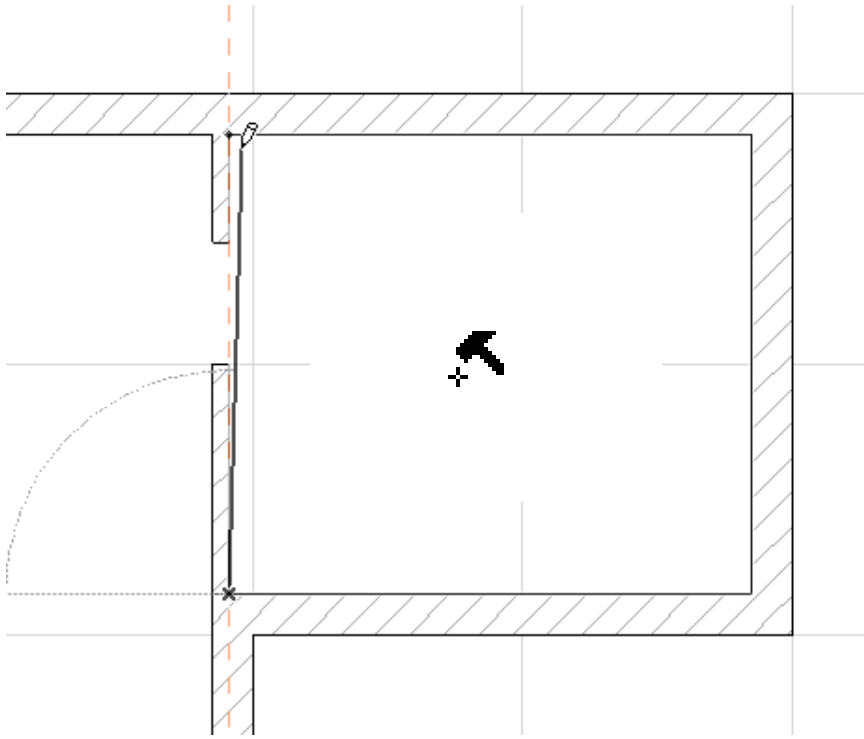

Зоне - просторије

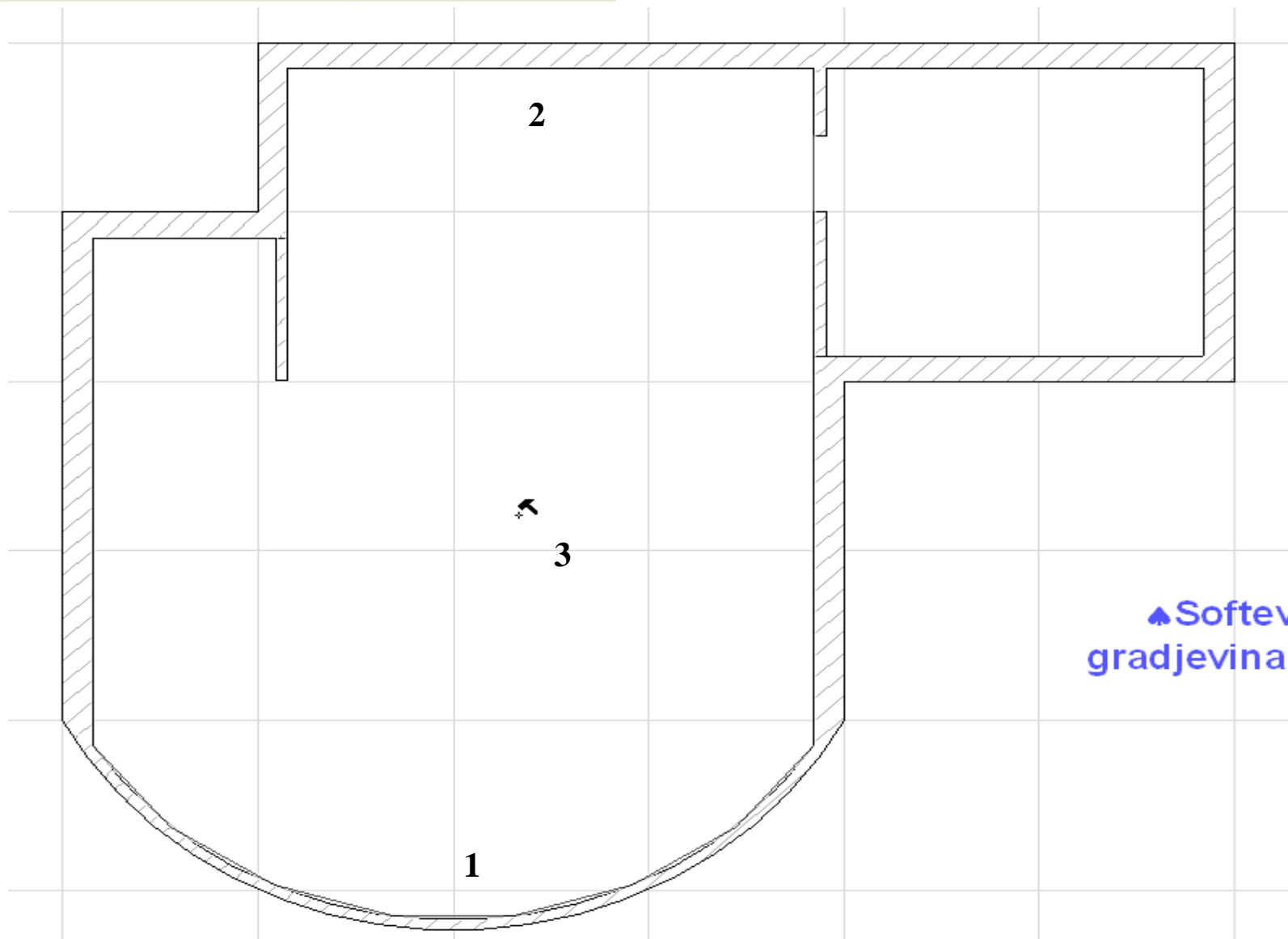
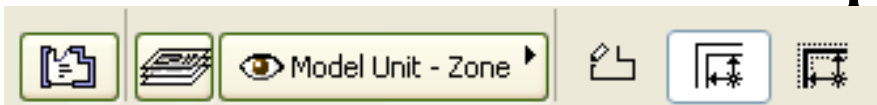

Зоне - просторије

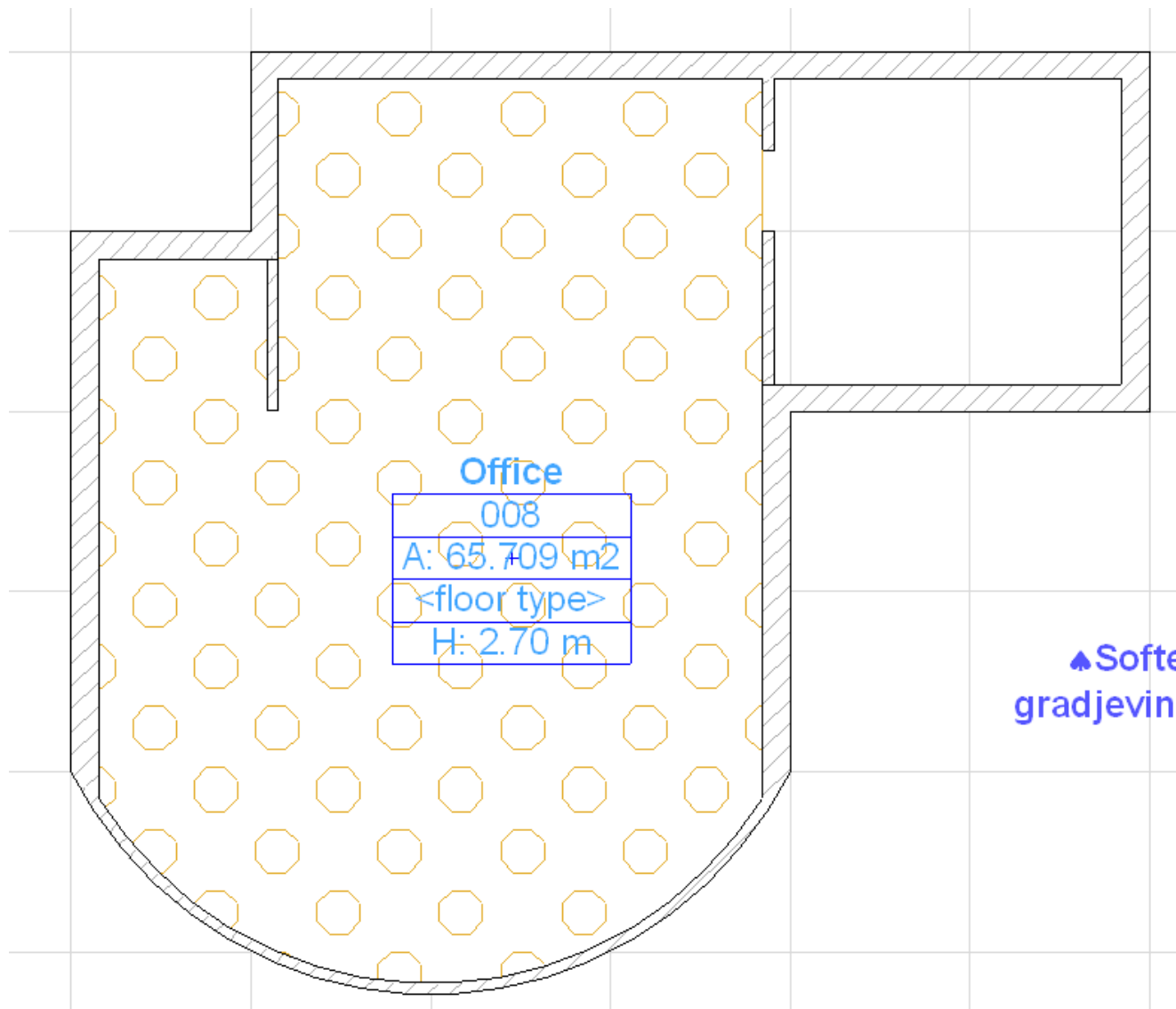

Mesh – Терен - Земљиште

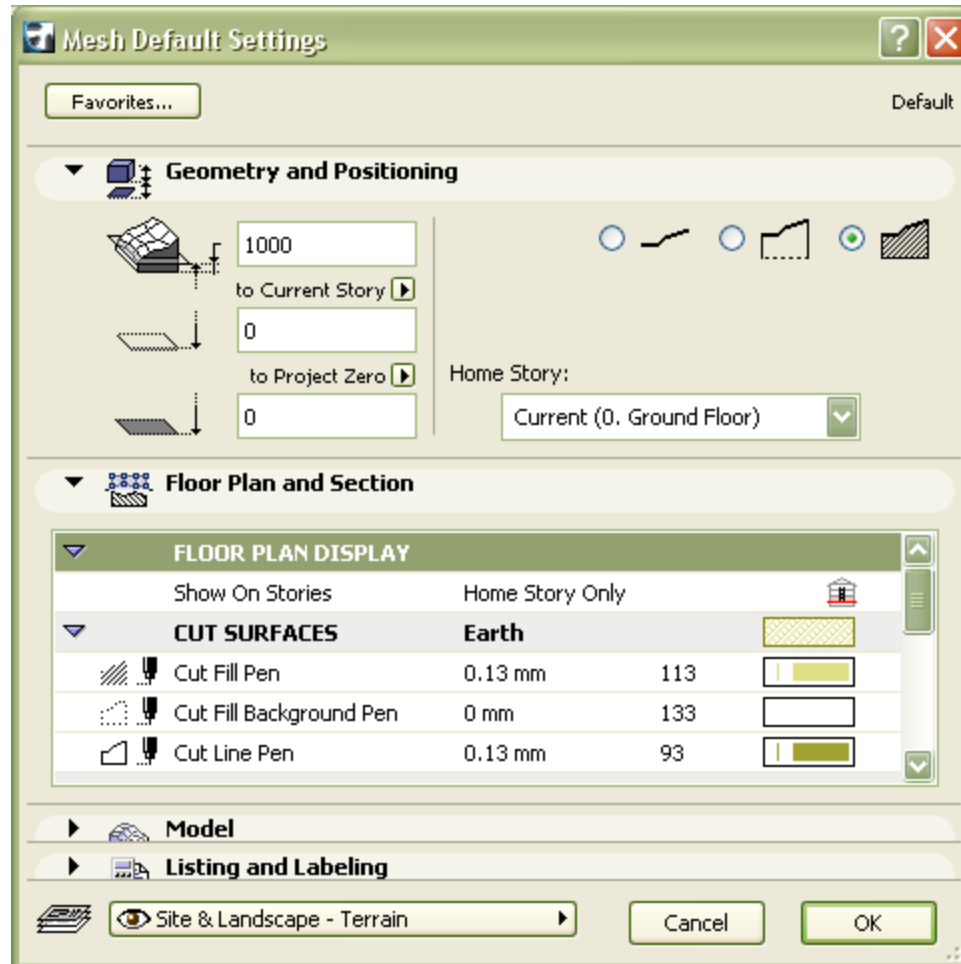
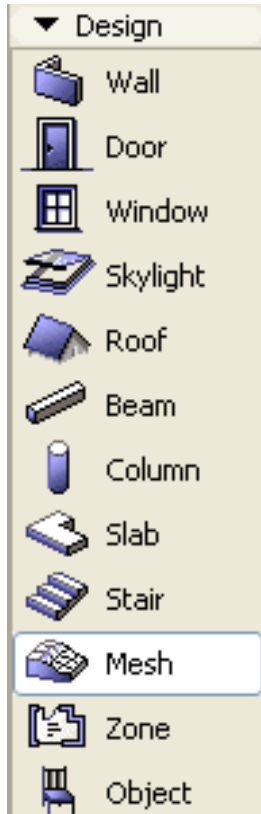

Mesh – Терен - Земљиште

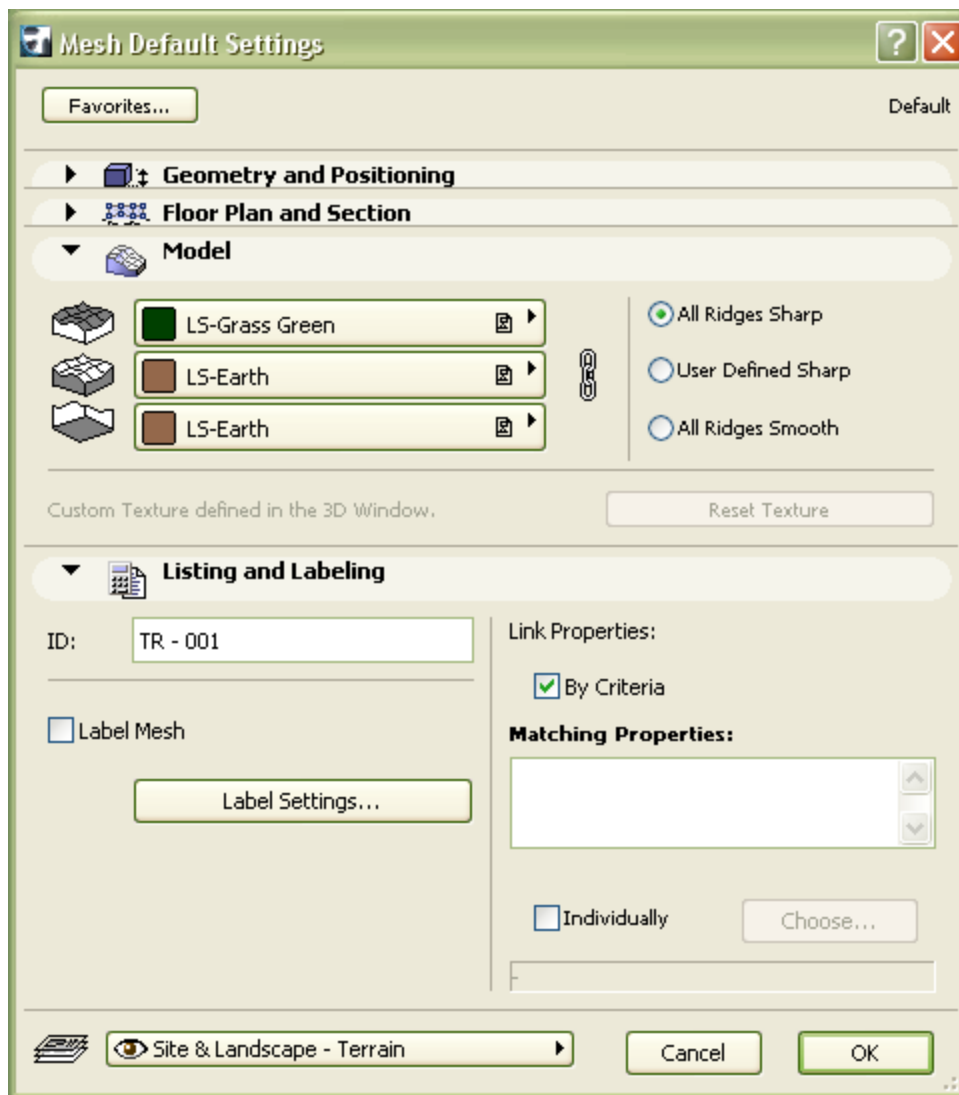

Mesh – Терен - Земљиште

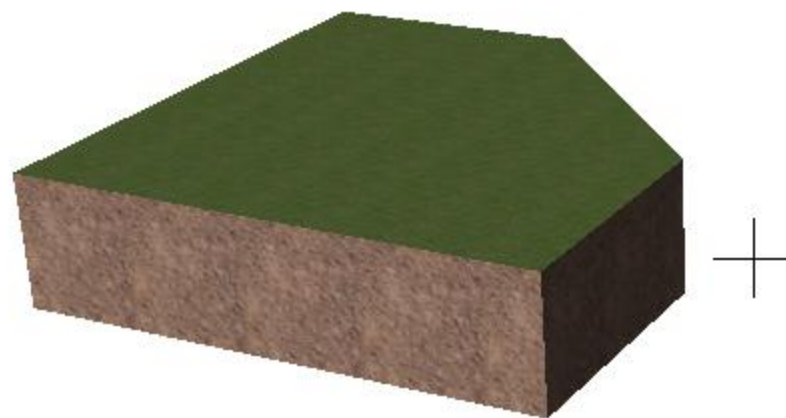
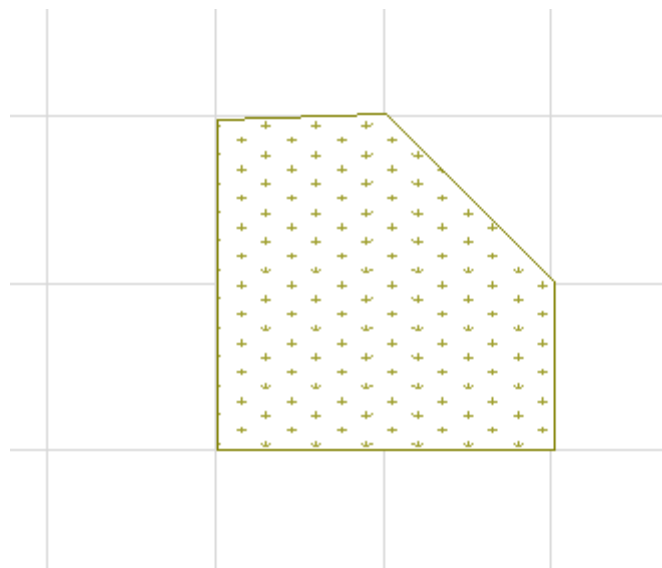
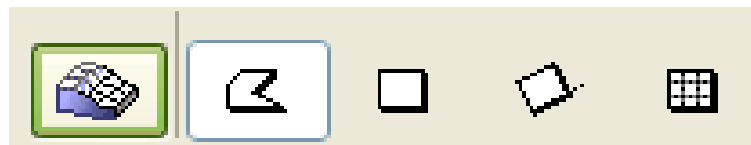

Mesh – Терен - Земљиште

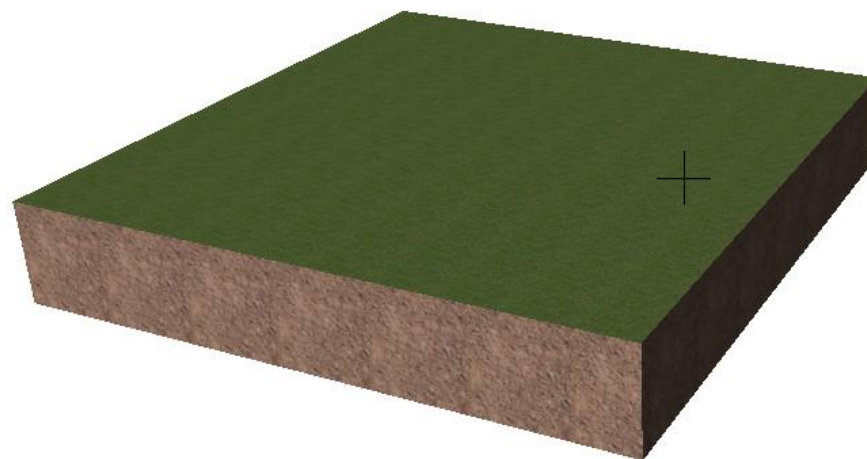
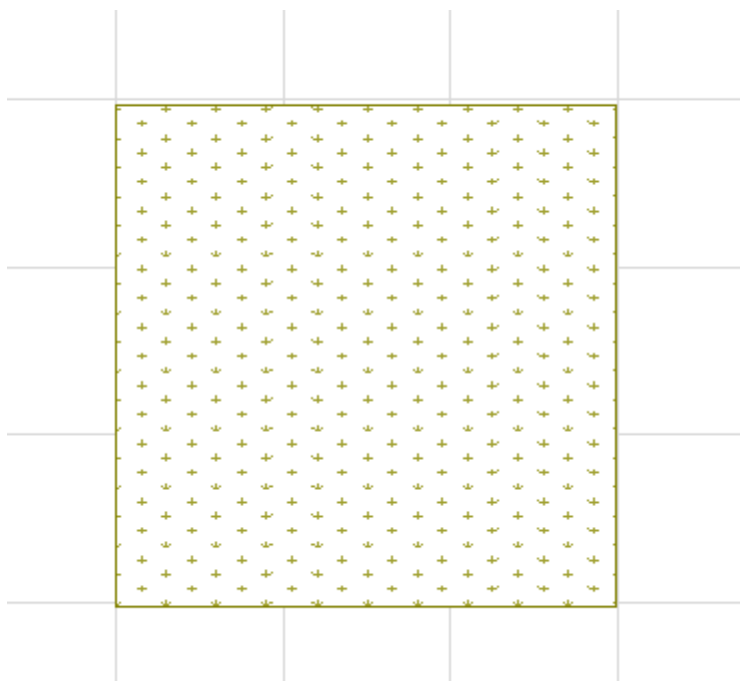
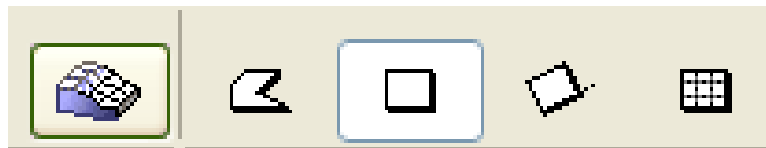

Mesh – Терен - Земљиште

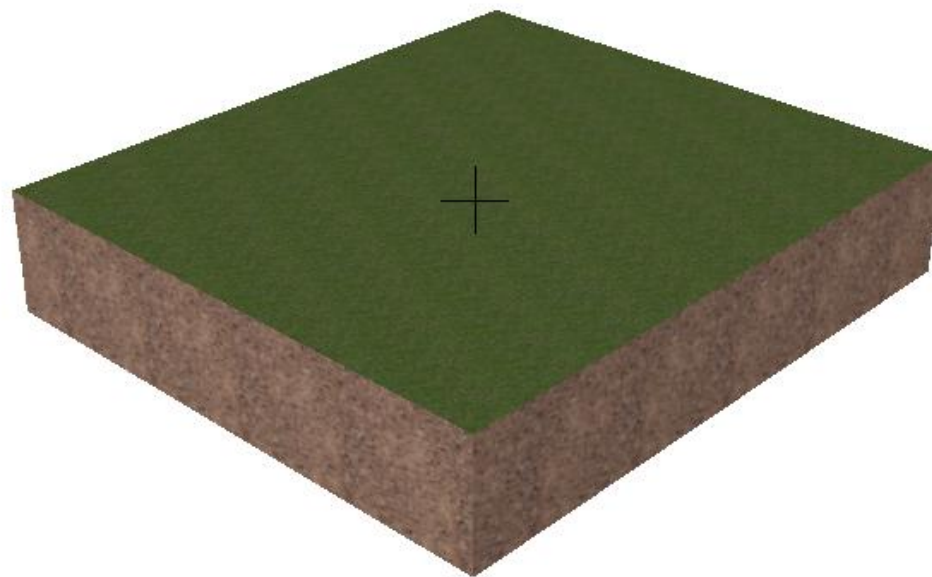
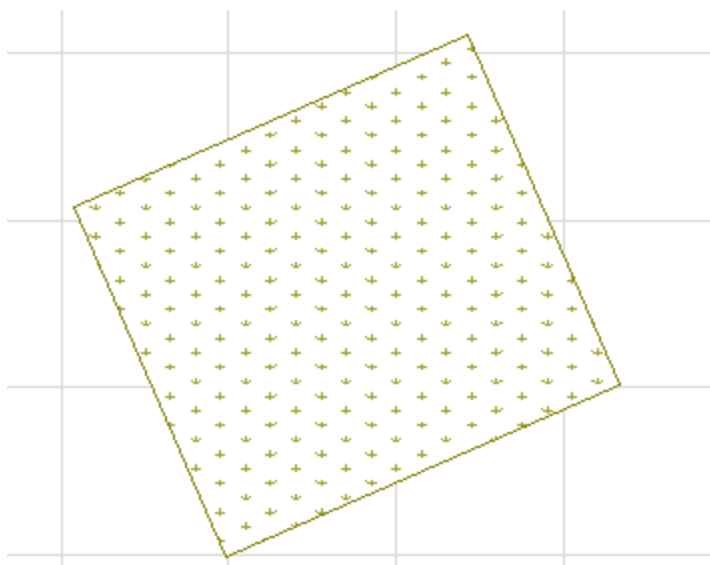
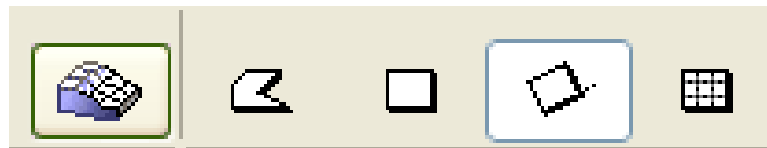

Mesh – Терен - Земљиште

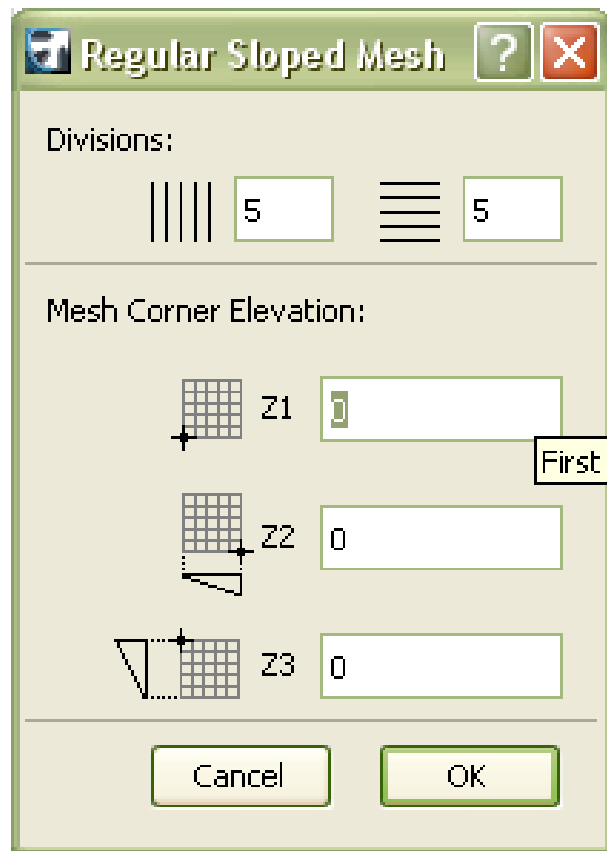
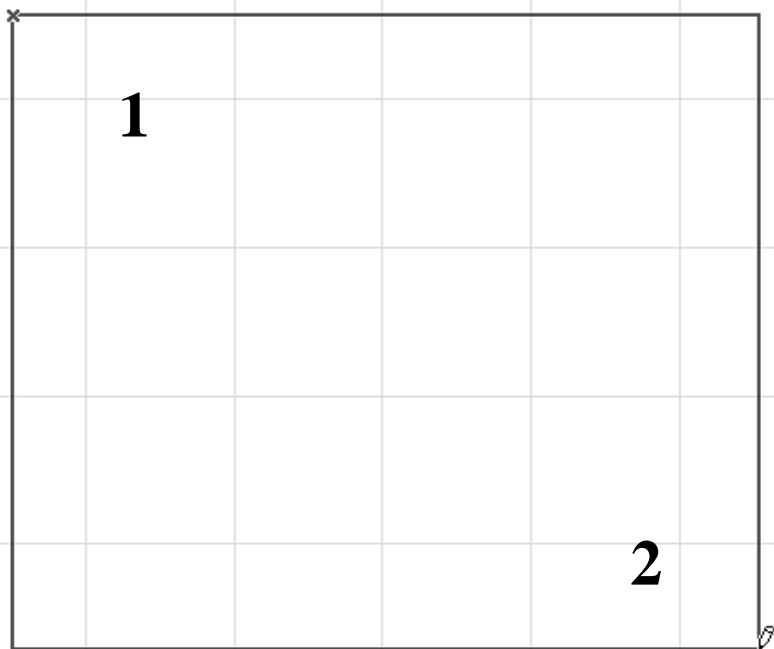
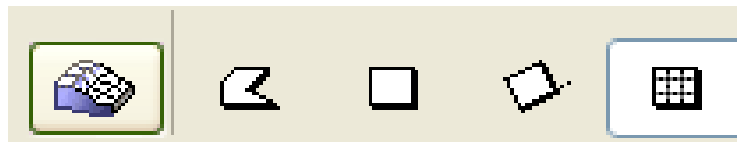

Mesh – Терен - Земљиште

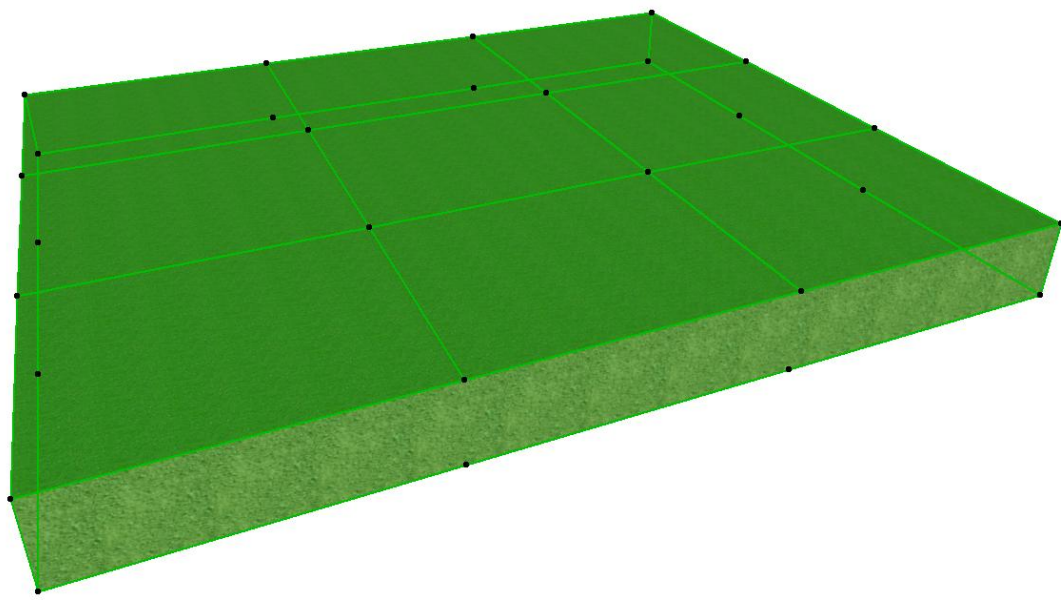
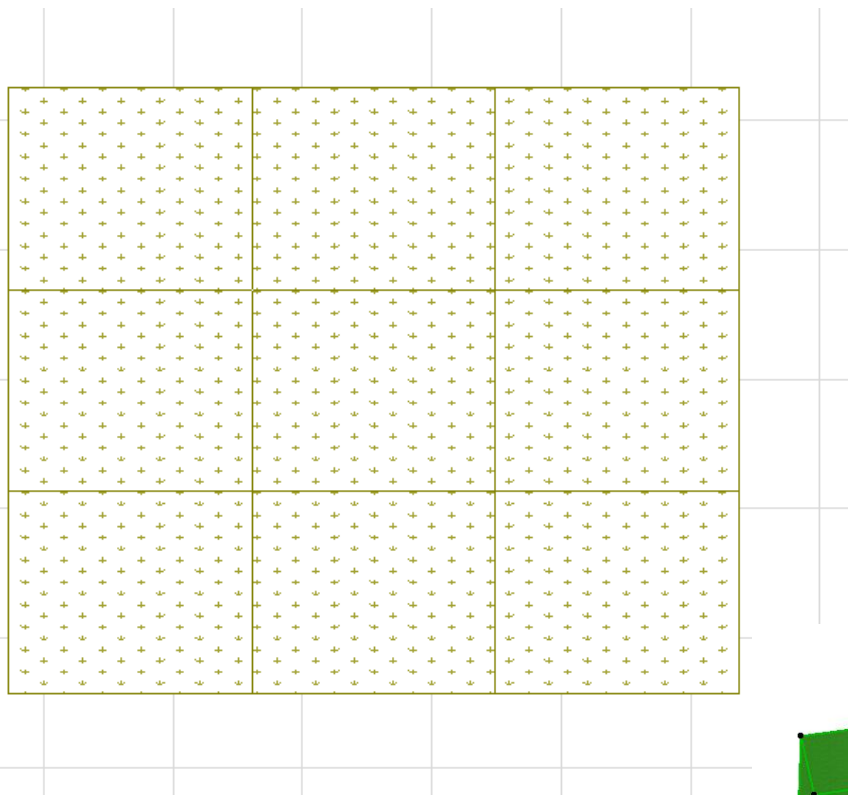

Mesh – Терен - Земљиште

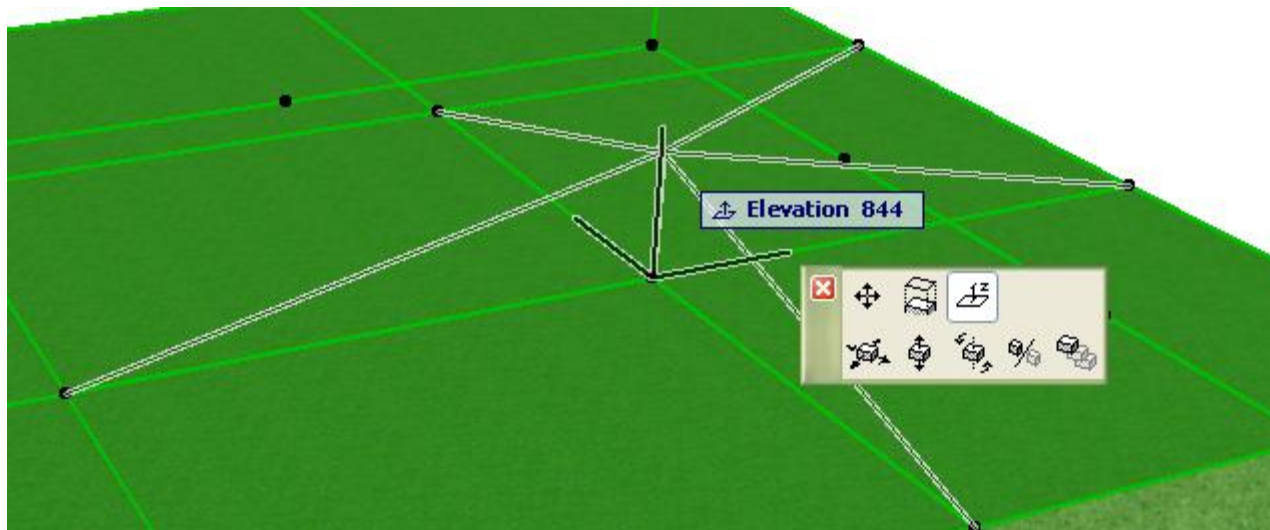
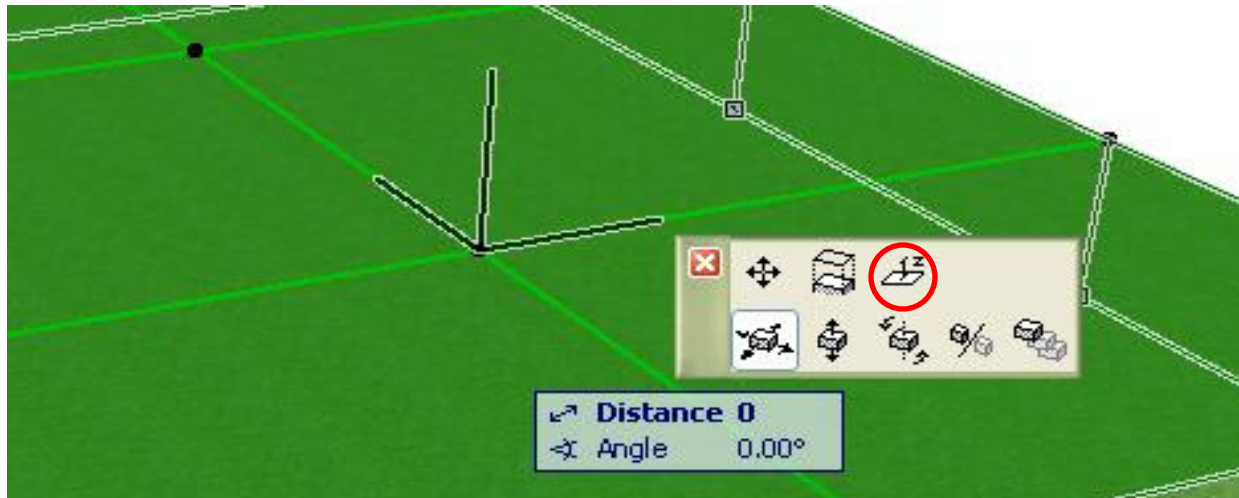

Mesh – Терен - Земљиште

