

Софтвери у грађевинарству

мр Вуле Алексић, проф.

Предавање V

Прозори

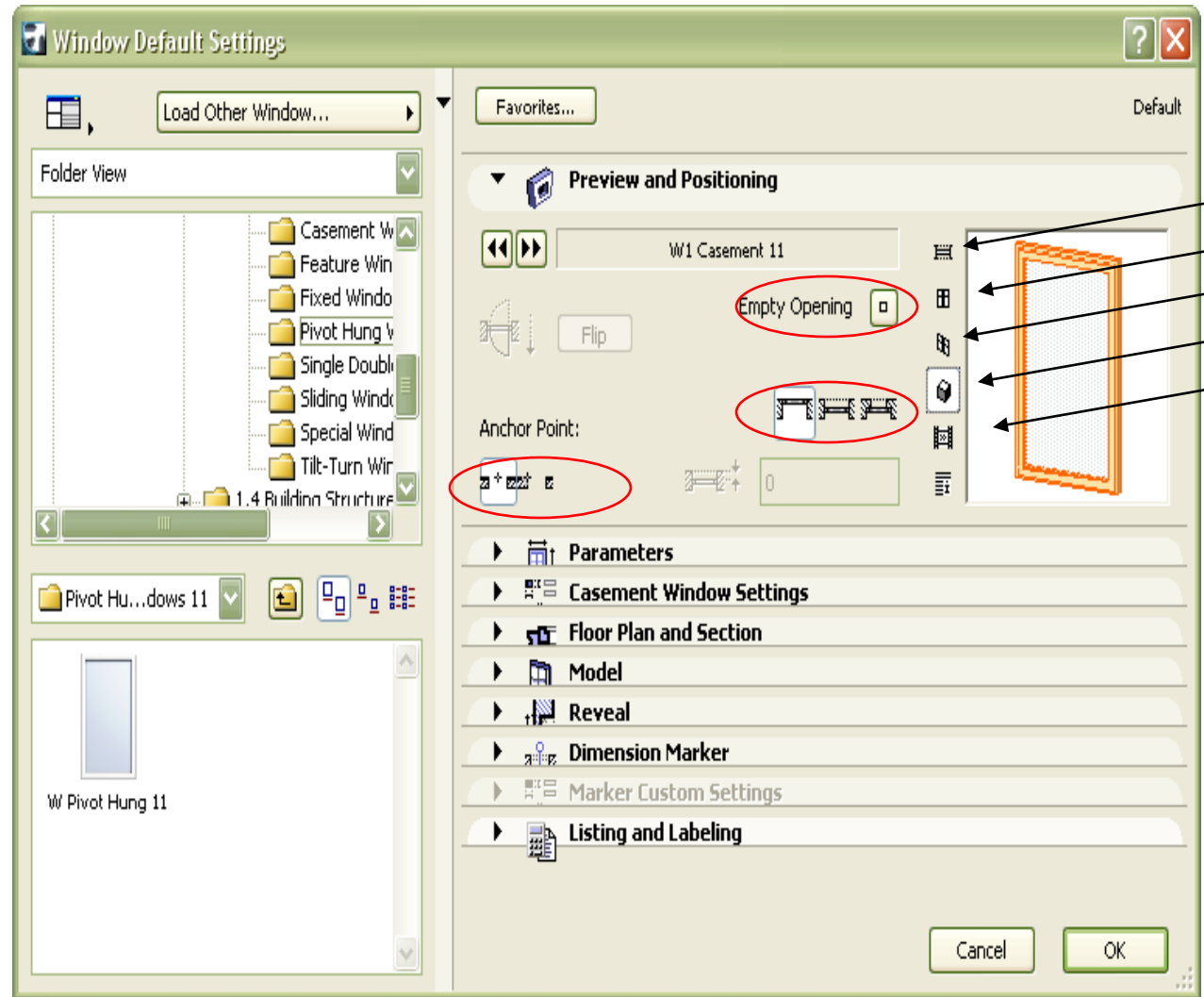
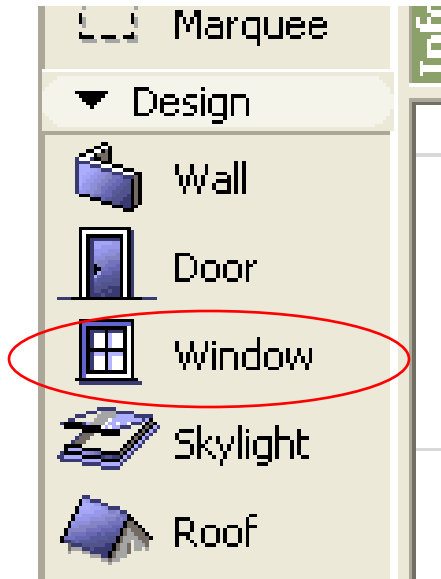

Прозори

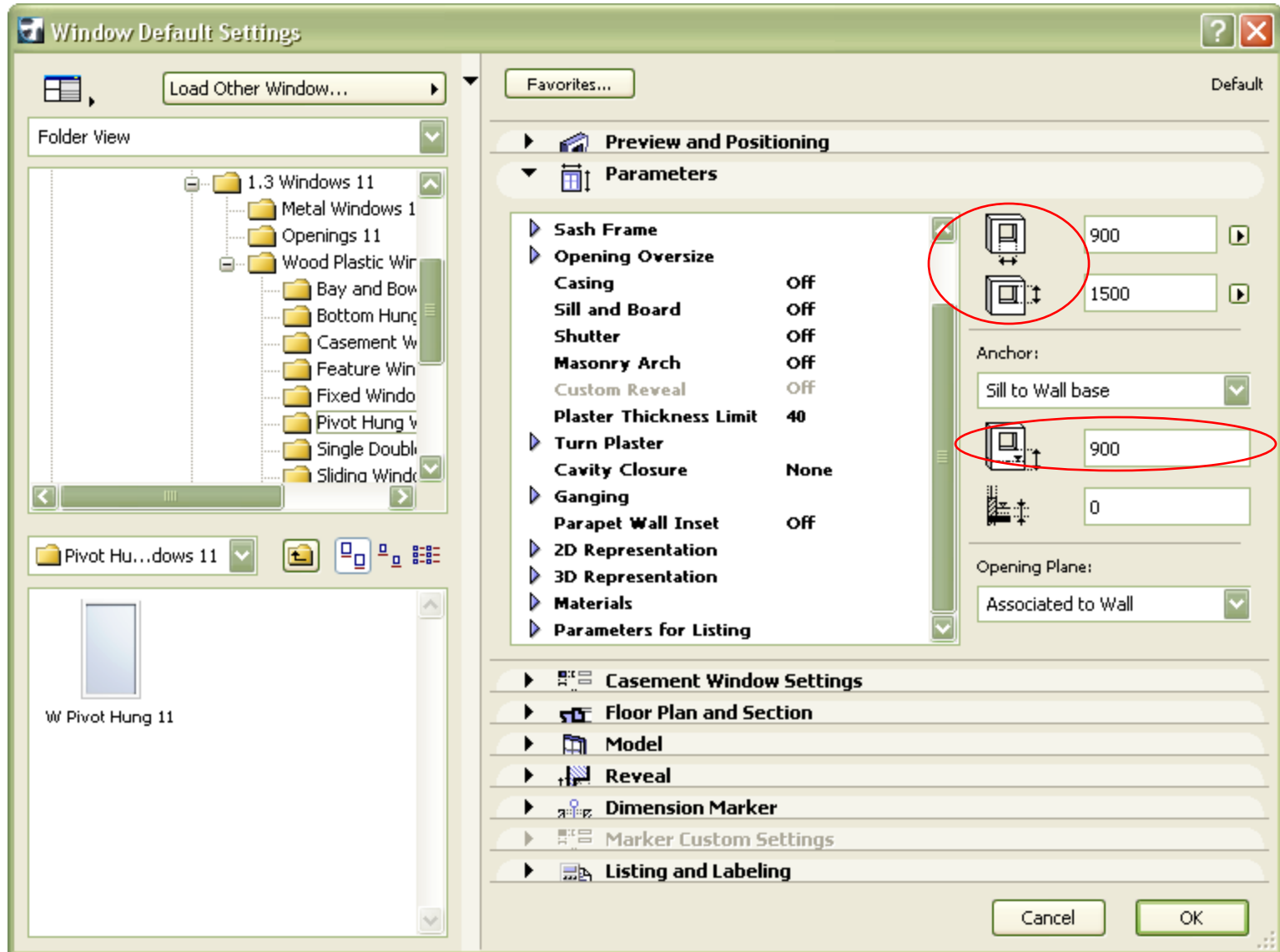

Прозори

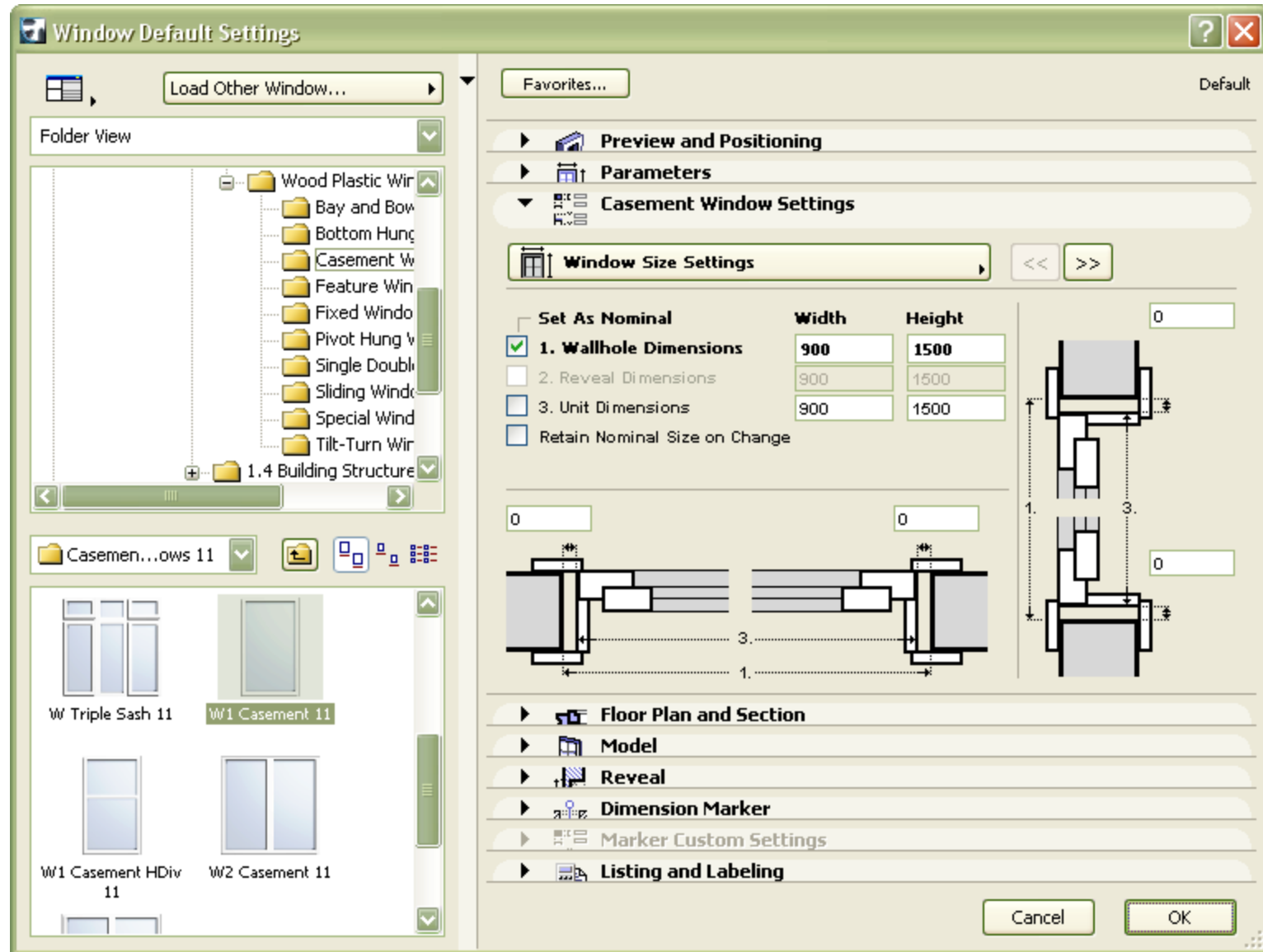

Прозори

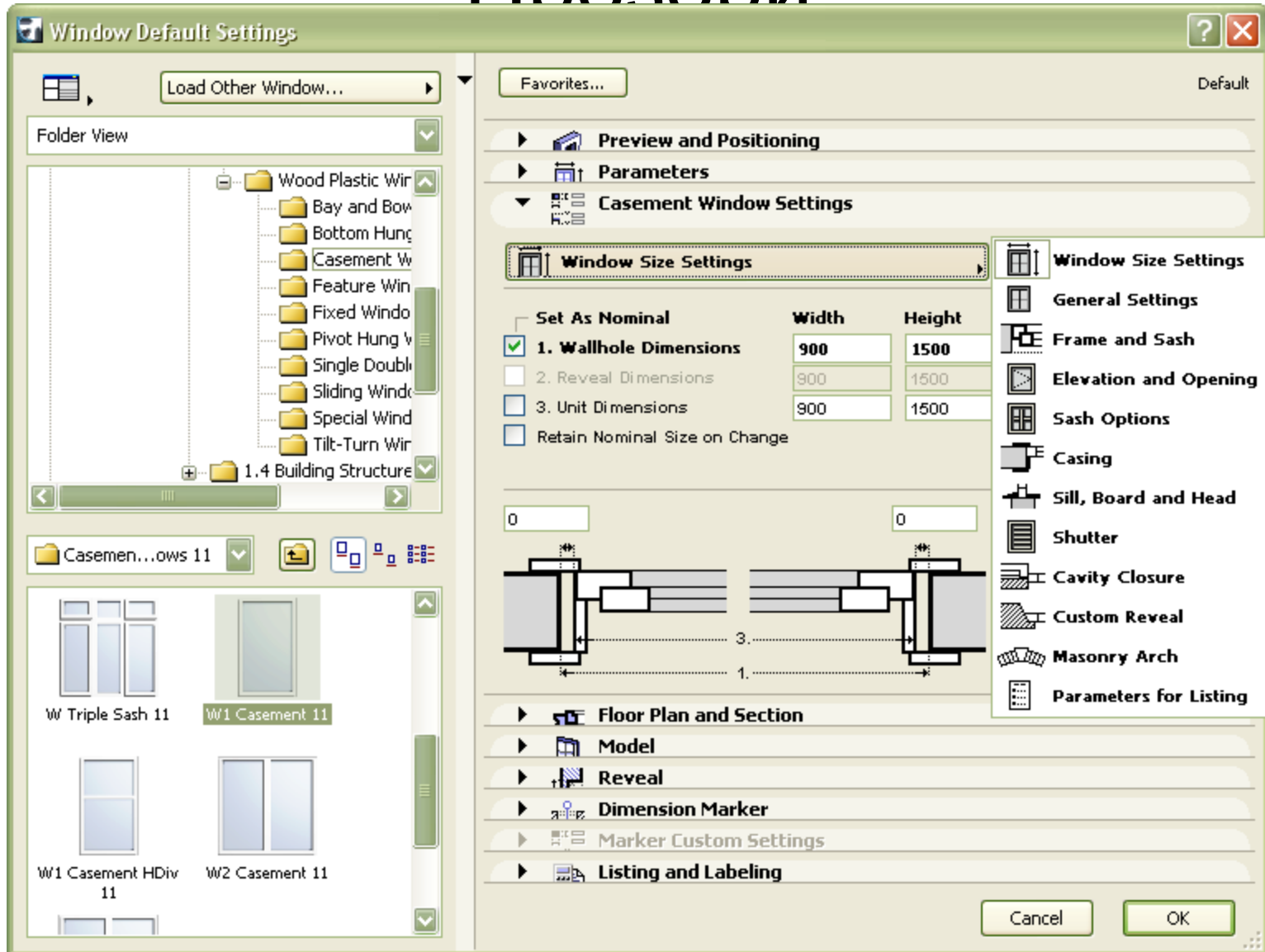

Прозори

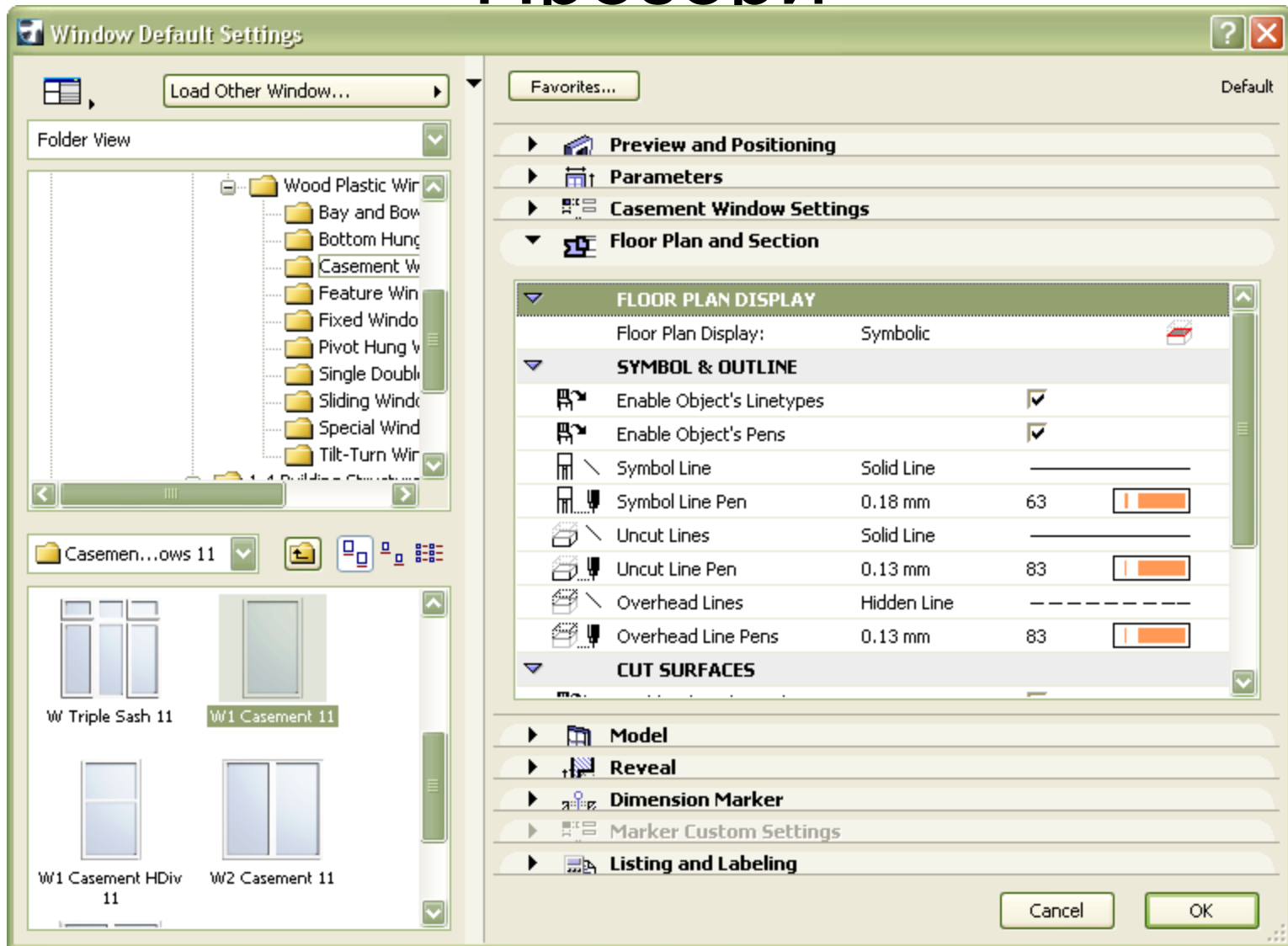

Прозори

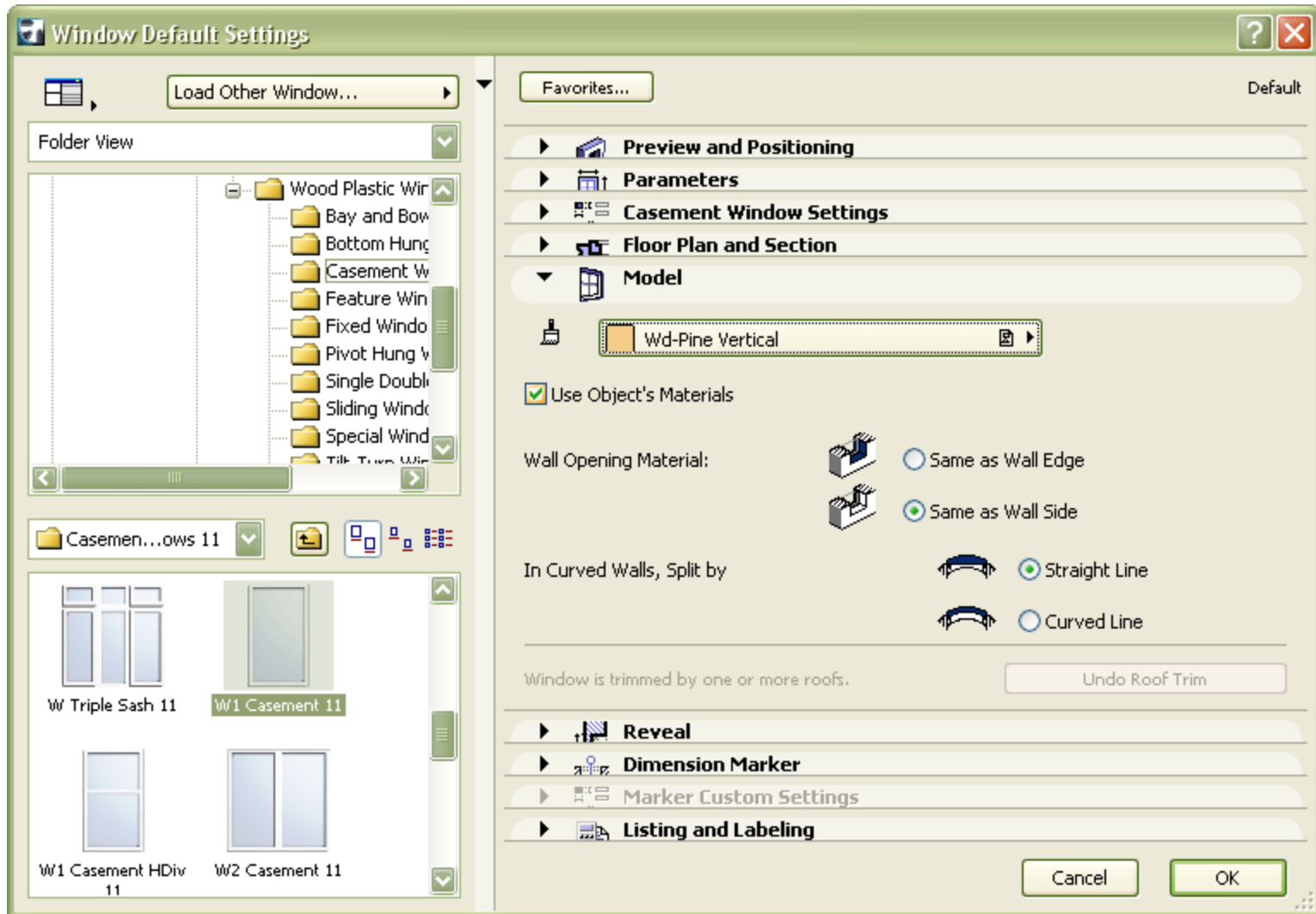

Прозори

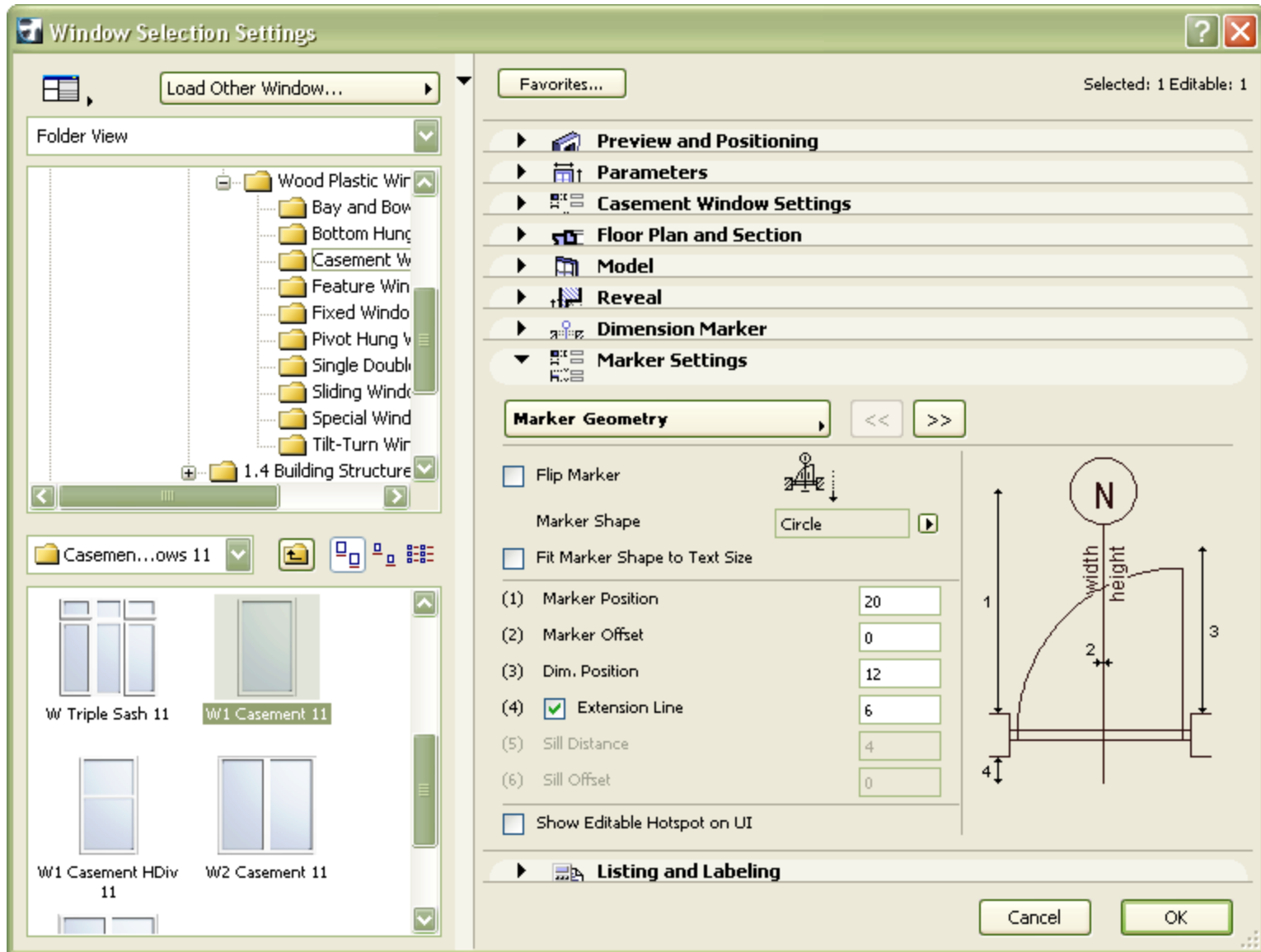

Прозори

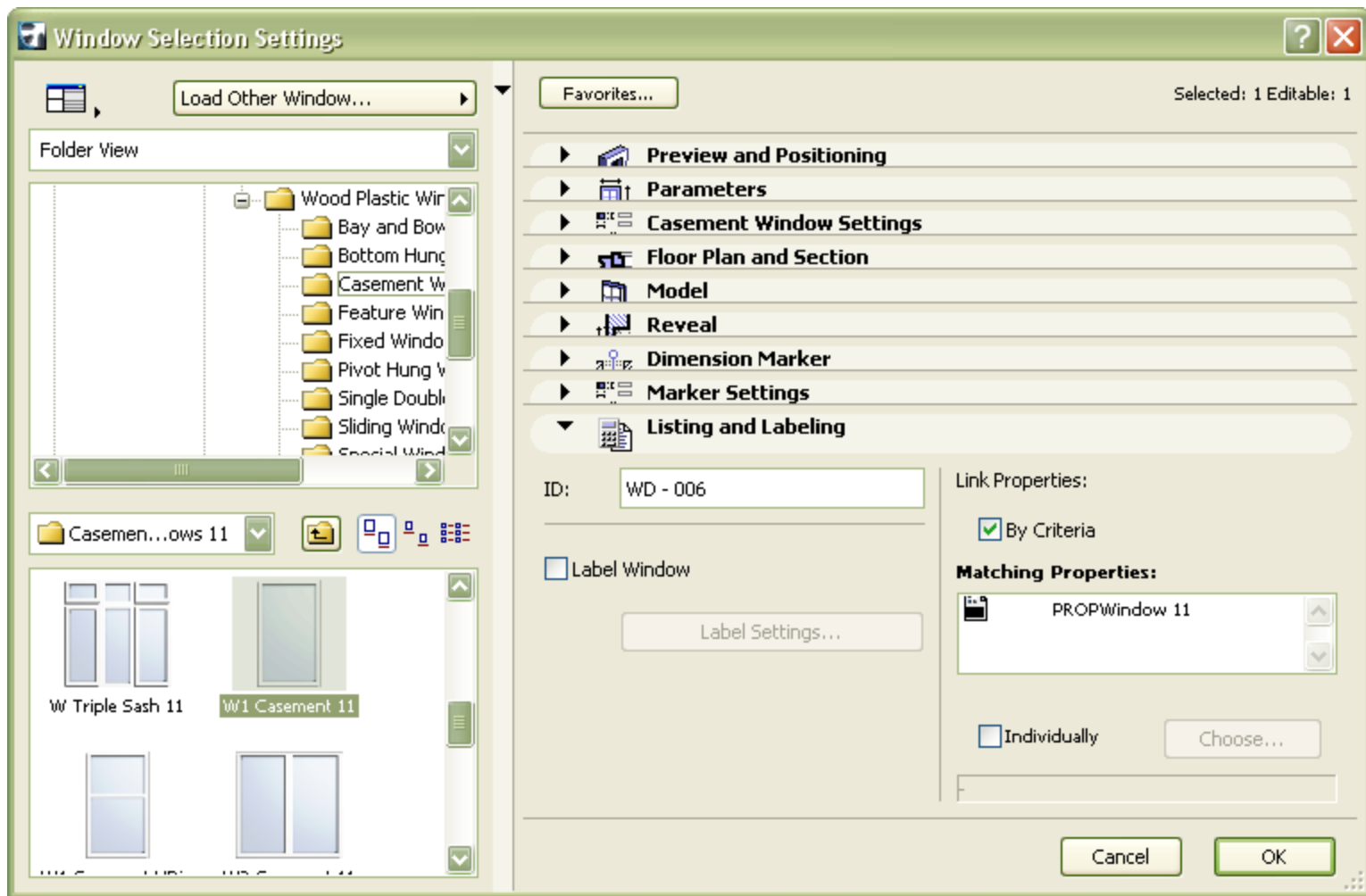

Врата

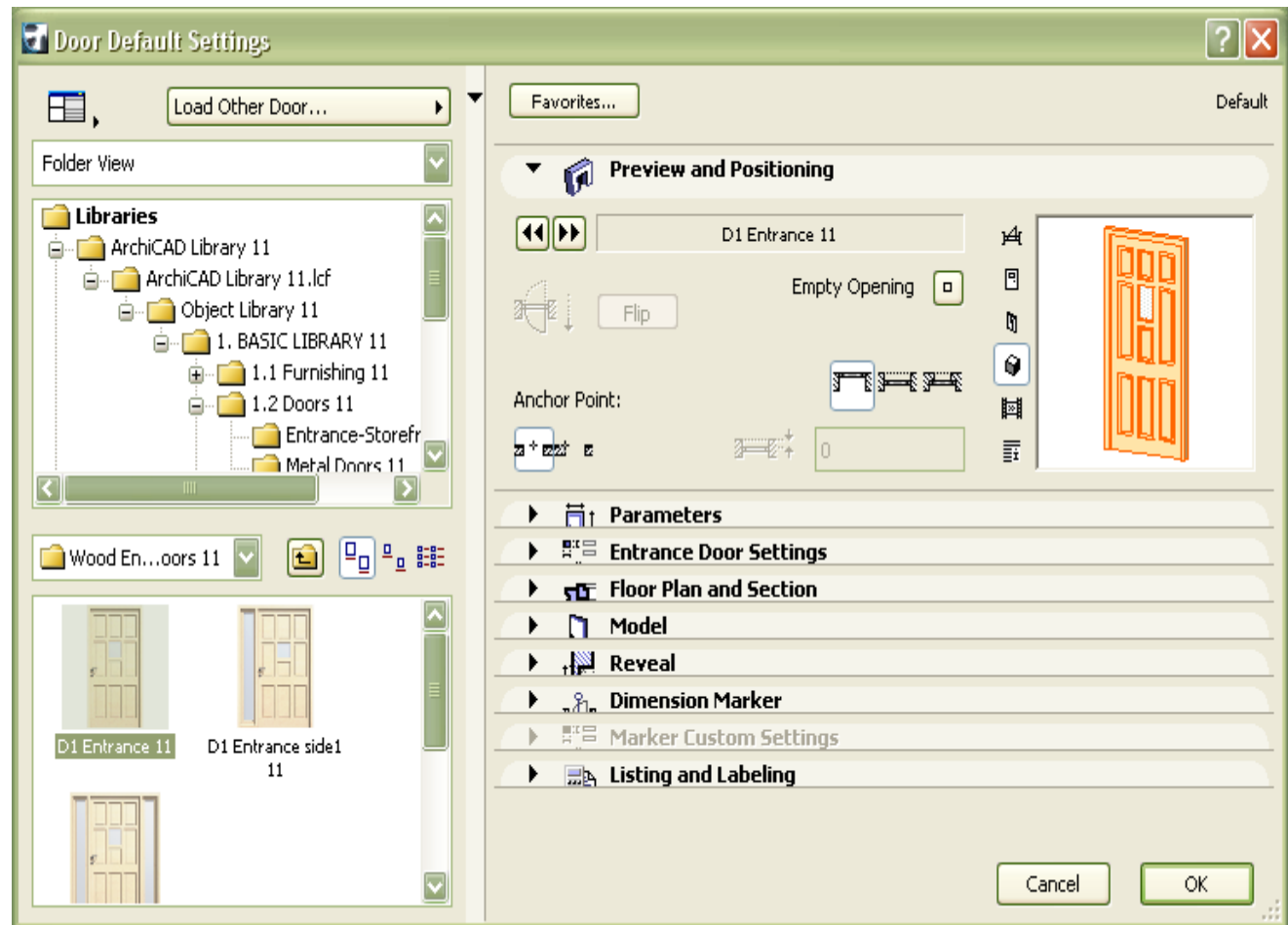

Врата

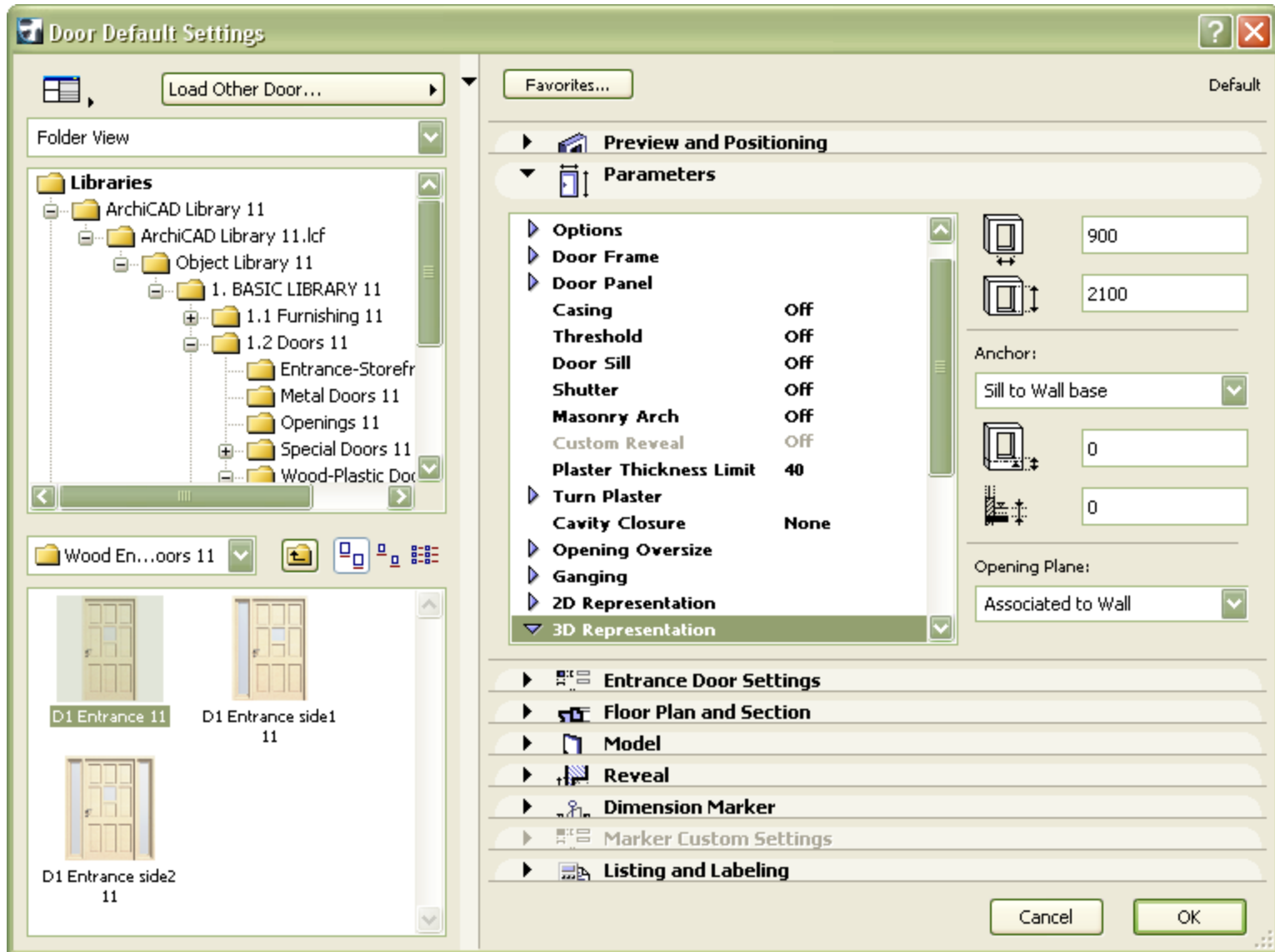

Врата

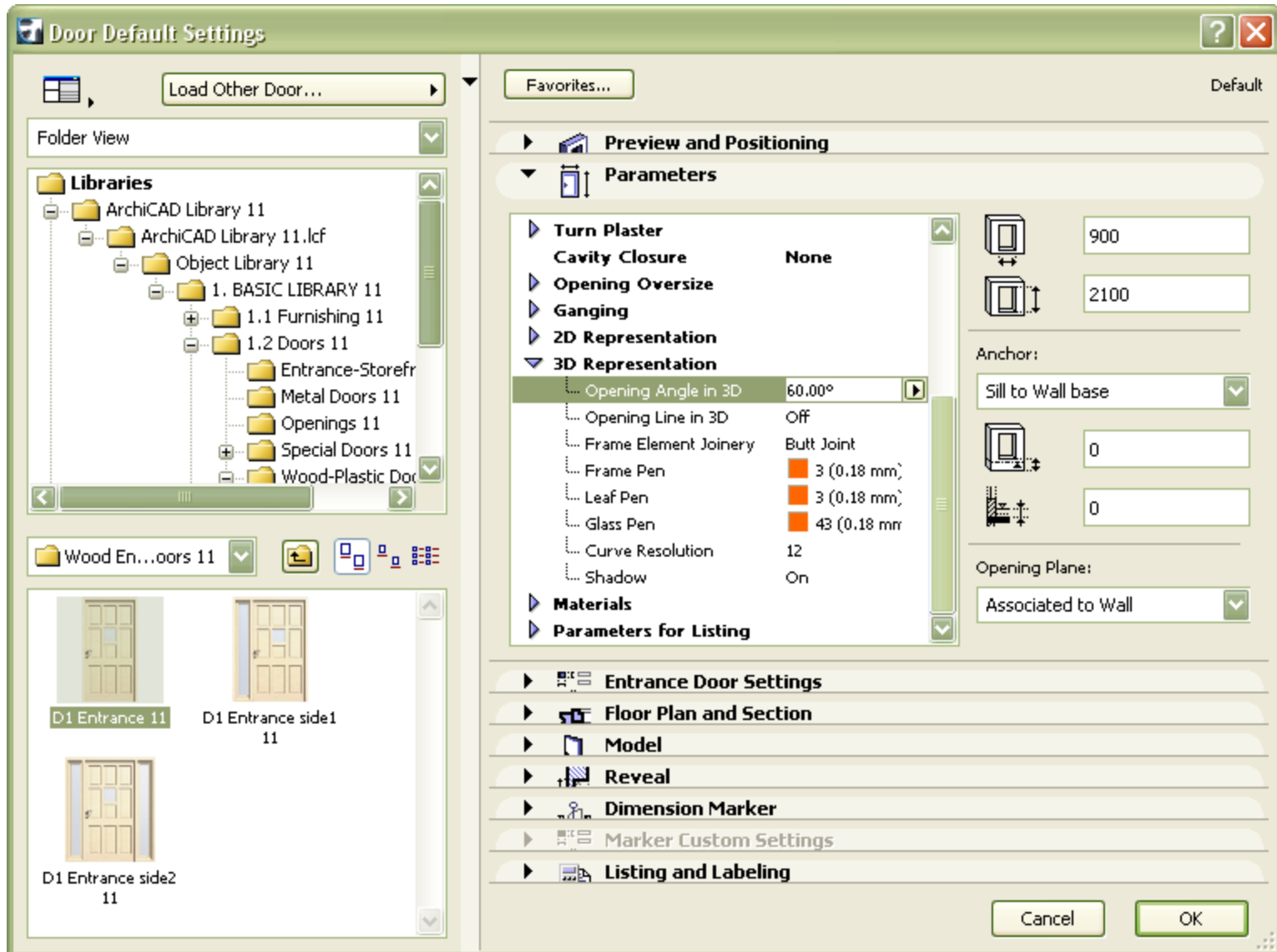

Врата

Door Default Settings [?] [X]

Load Other Door... Favorites... Default

Folder View

Libraries

- ArchiCAD Library 11
 - ArchiCAD Library 11.lcf
 - Object Library 11
 - 1. BASIC LIBRARY 11
 - 1.1 Furnishing 11
 - 1.2 Doors 11
 - Entrance-Storefr
 - Metal Doors 11
 - Openings 11
 - Special Doors 11
 - Wood-Plastic Doc

Wood En...doors 11

D1 Entrance 11 D1 Entrance side1 11

D1 Entrance side2 11

Door Size Settings << >>

Set As Nominal

| | Width | Height |
|--|-------|--------|
| <input checked="" type="checkbox"/> 1. Wallhole Dimensions | 900 | 2100 |
| <input type="checkbox"/> 2. Unit Dimensions | 900 | 2100 |
| <input type="checkbox"/> 3. Egress Dimensions | 800 | 2050 |
| <input type="checkbox"/> 4. Leaf Dimensions | 800 | 2050 |

Retain Nominal Size on Change

0

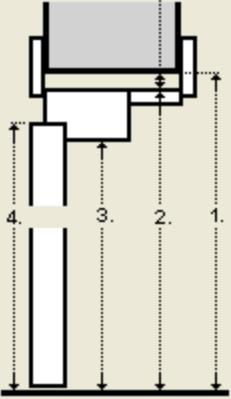

0



Floor Plan and Section

Model

Reveal

Dimension Marker

Marker Custom Settings

Listing and Labeling

Cancel OK

Врата

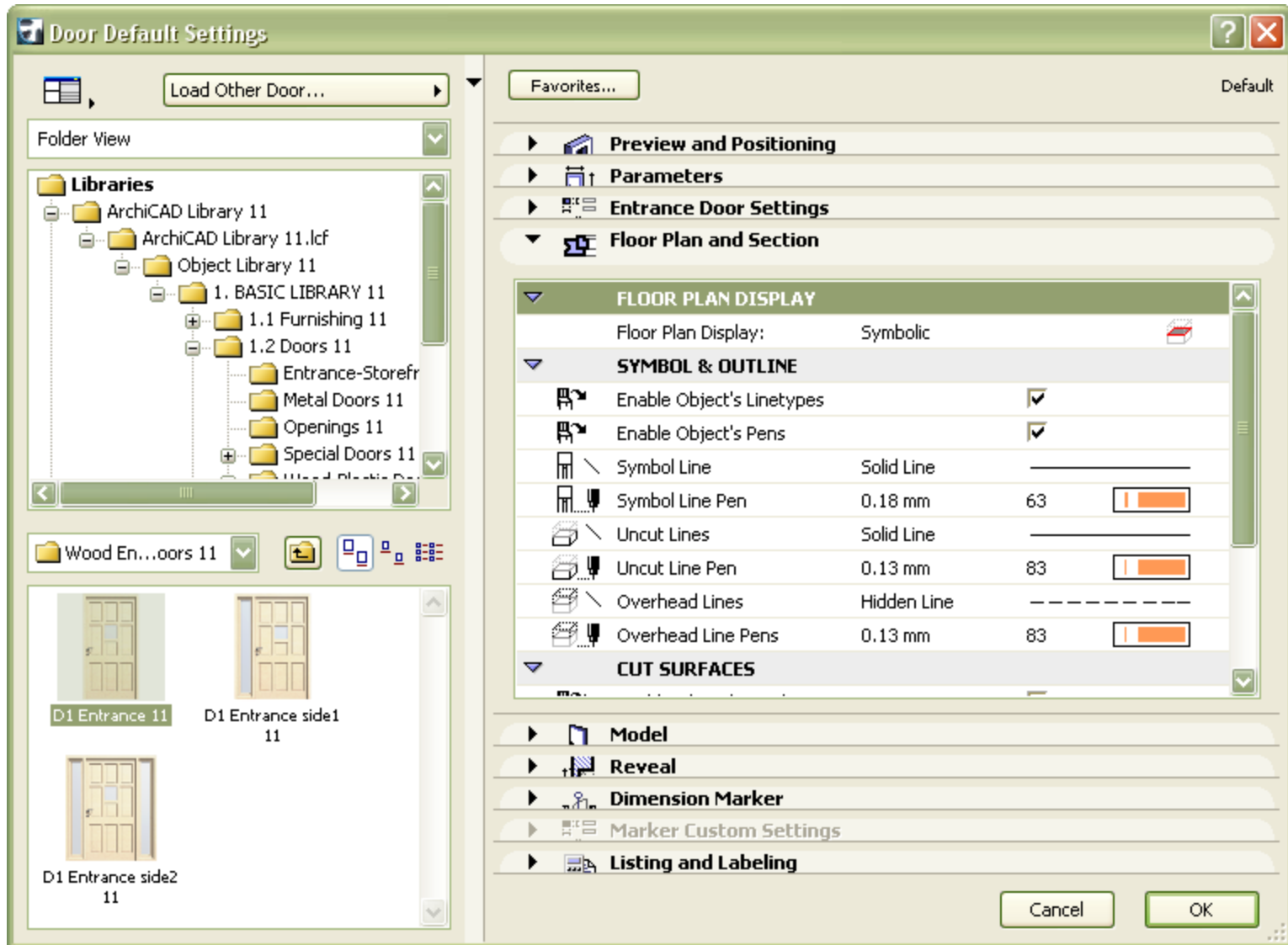

Врата

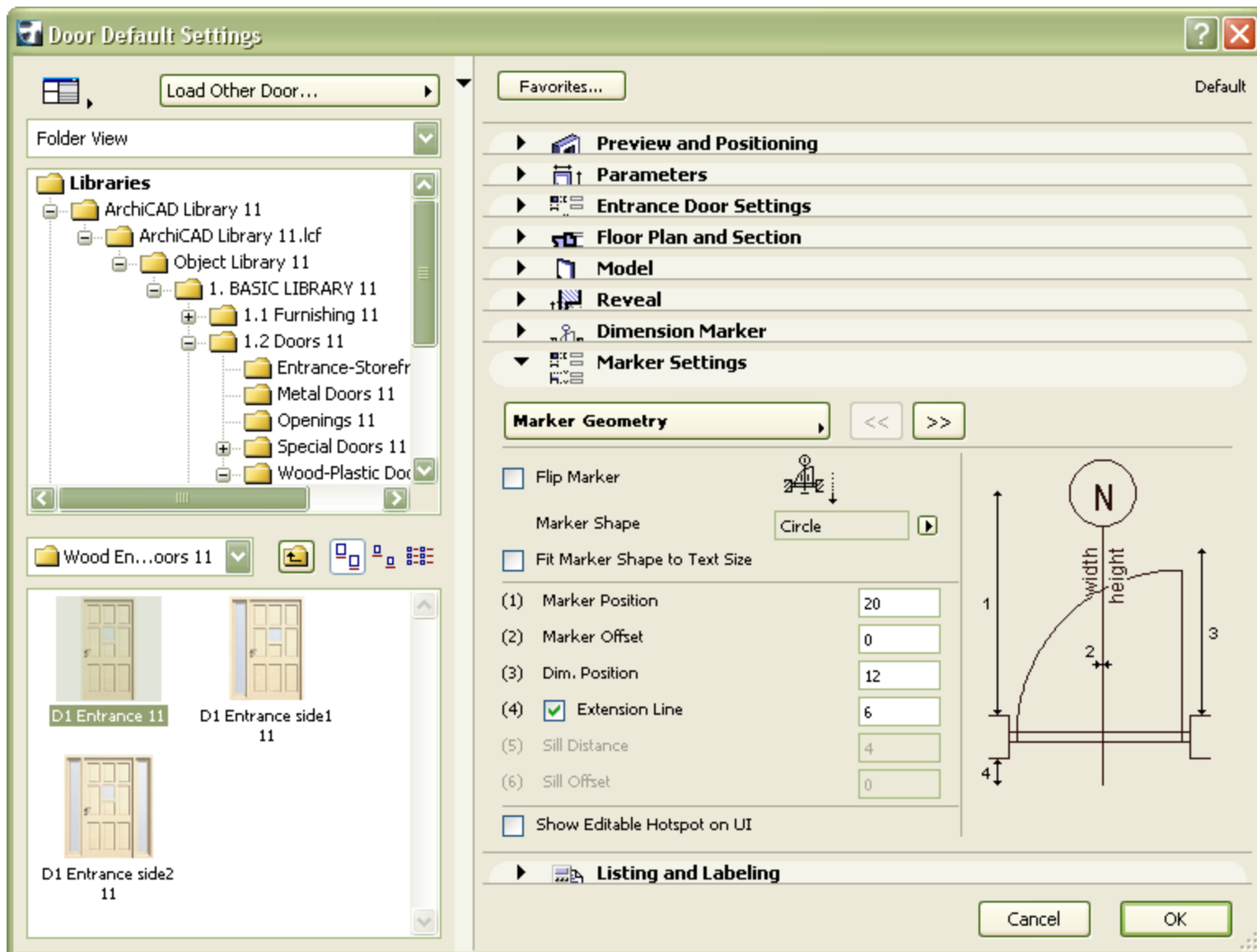

Врата

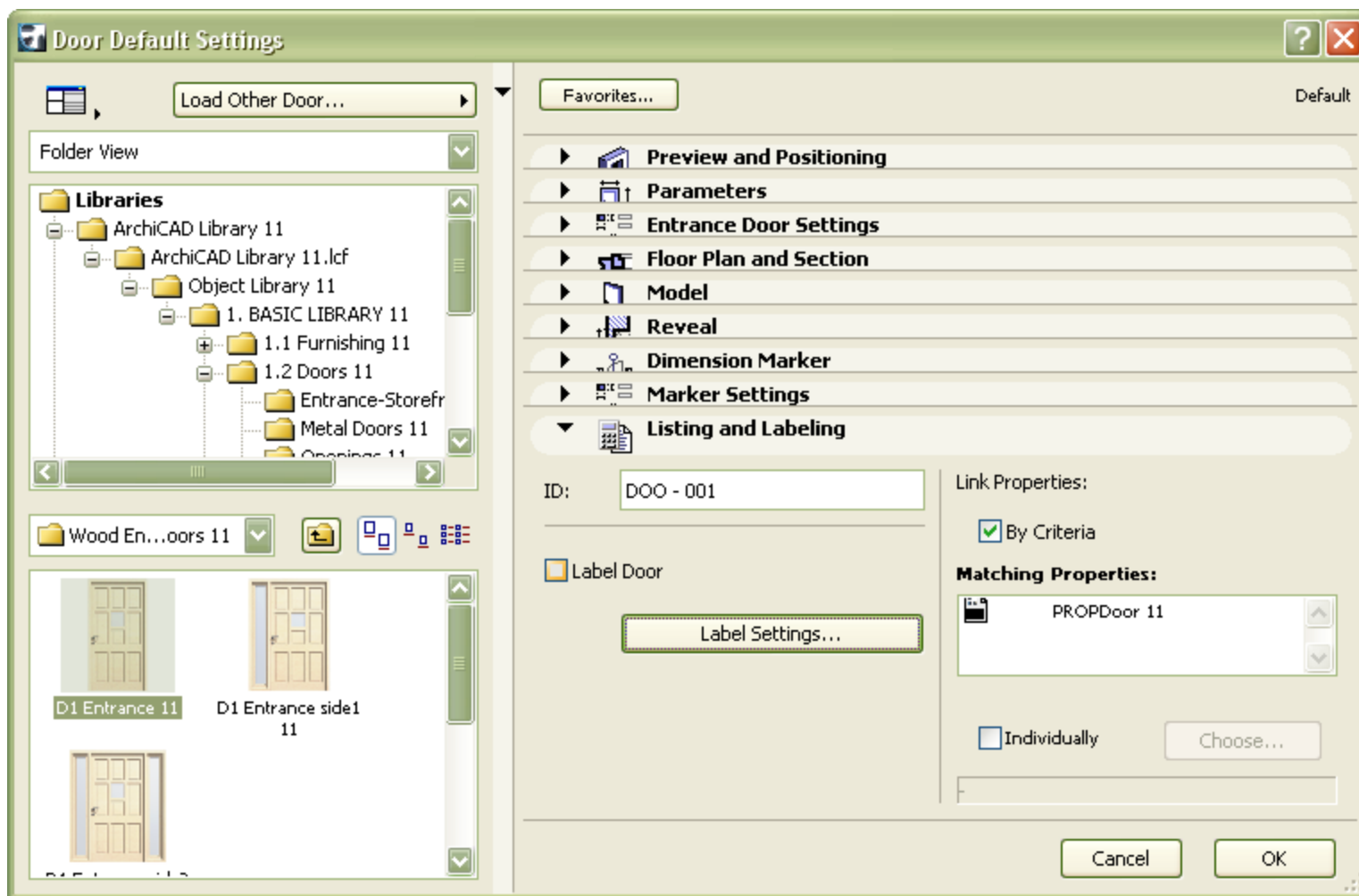

Врата

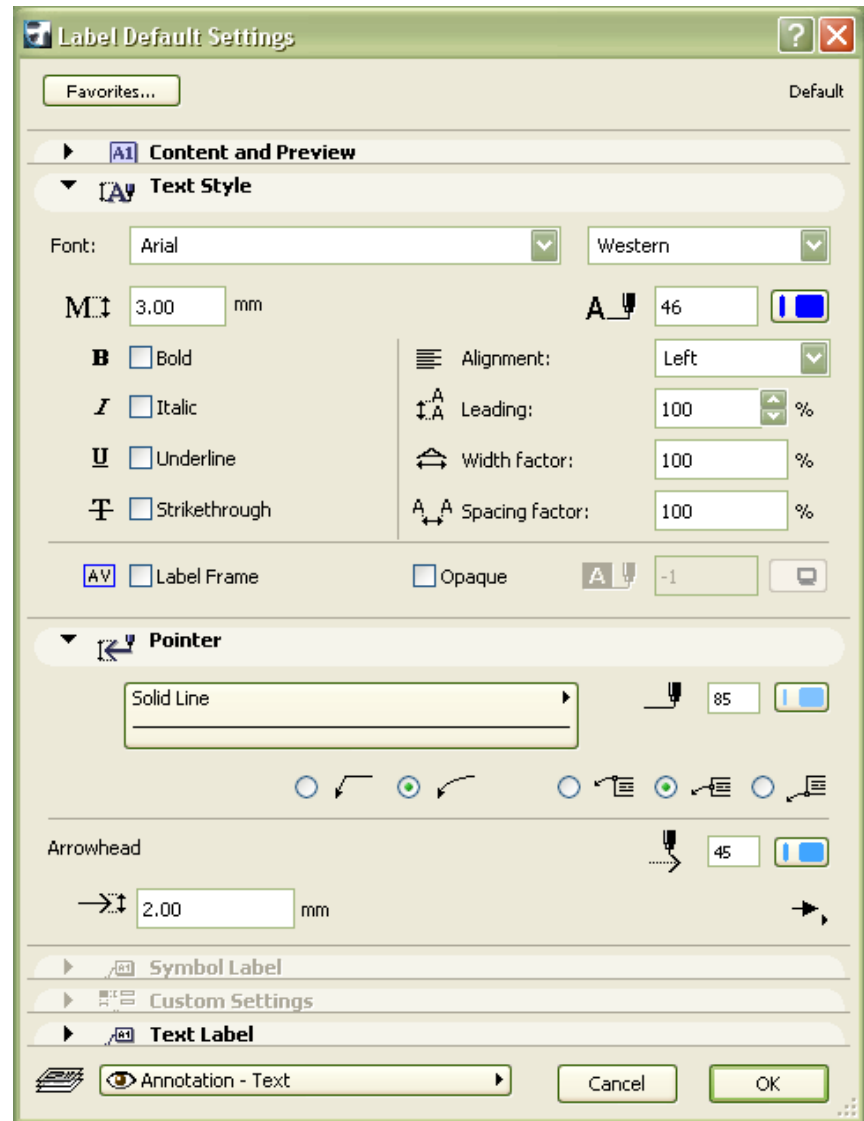
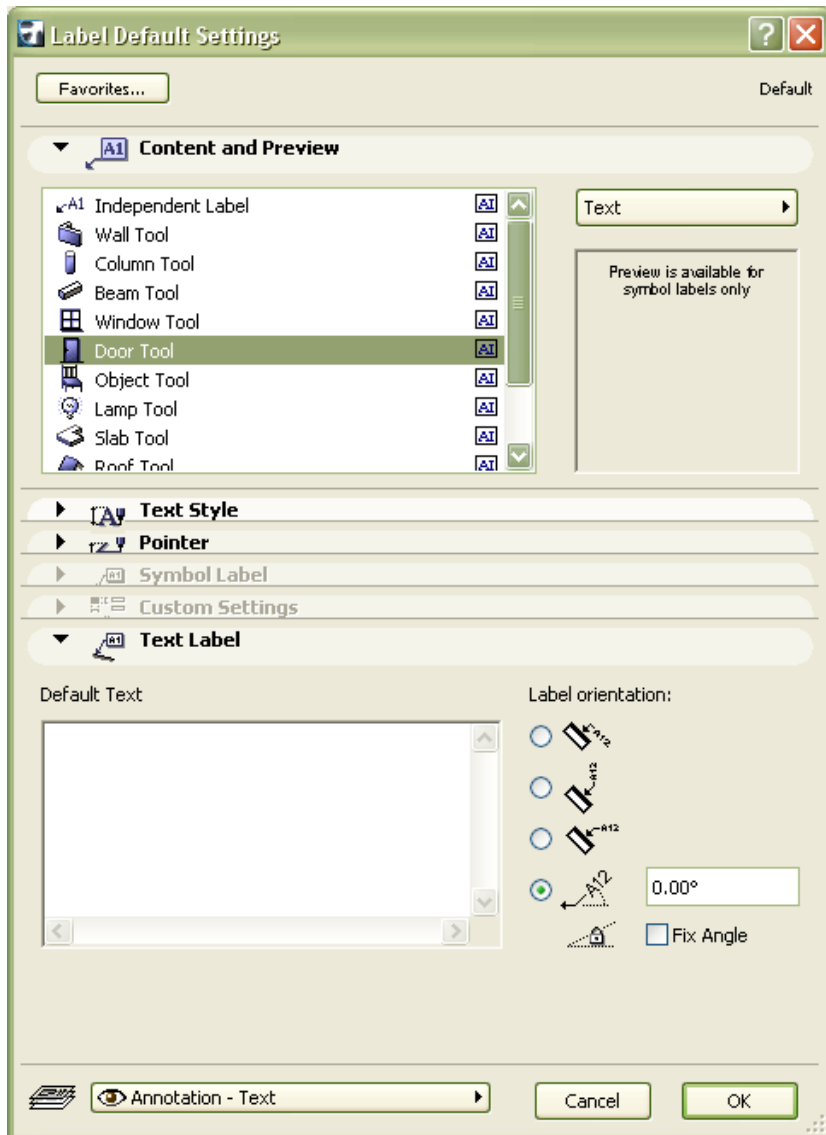

Врата и прозори постављање

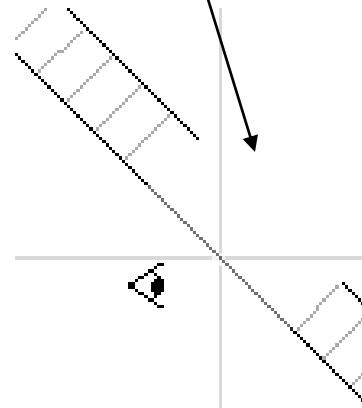
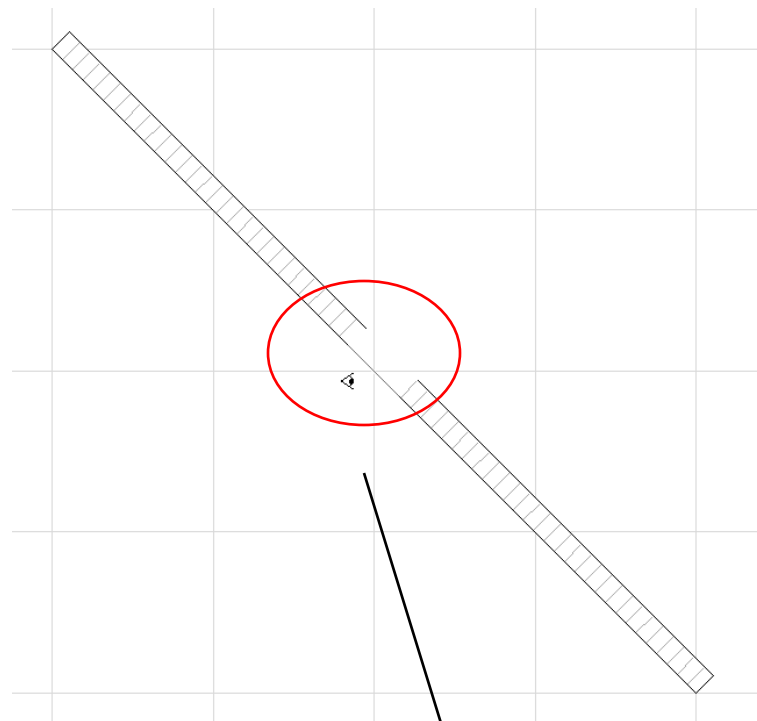
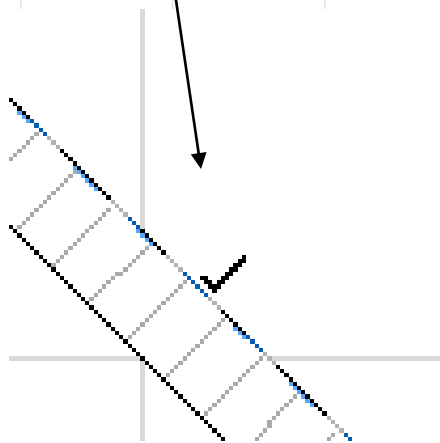
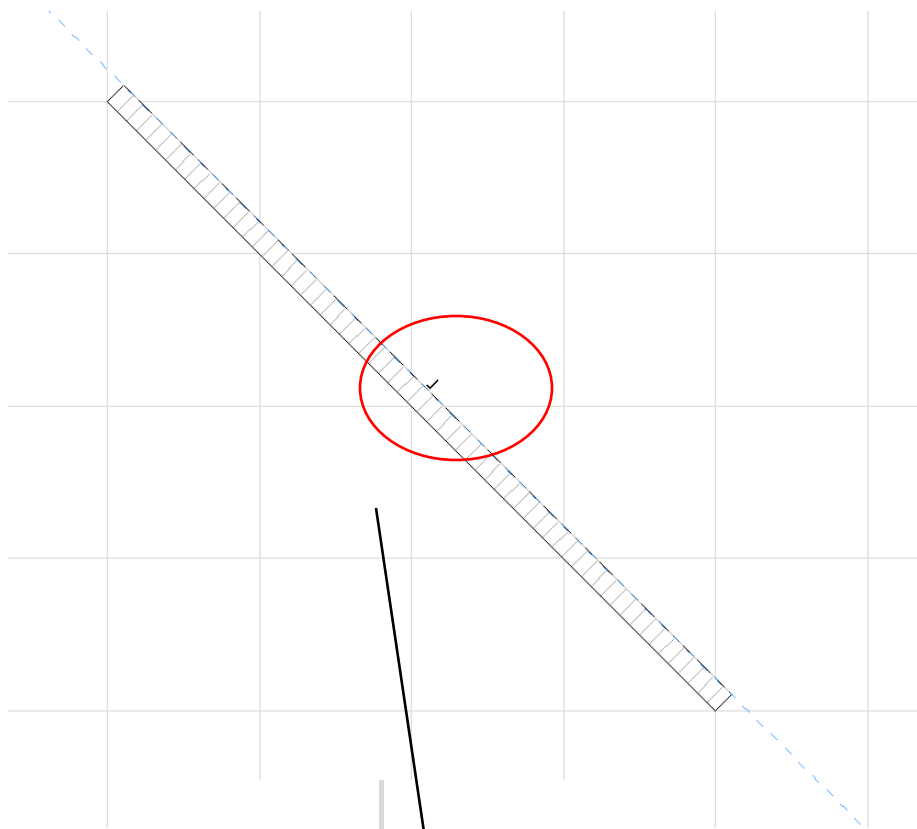

Врата и прозори постављање

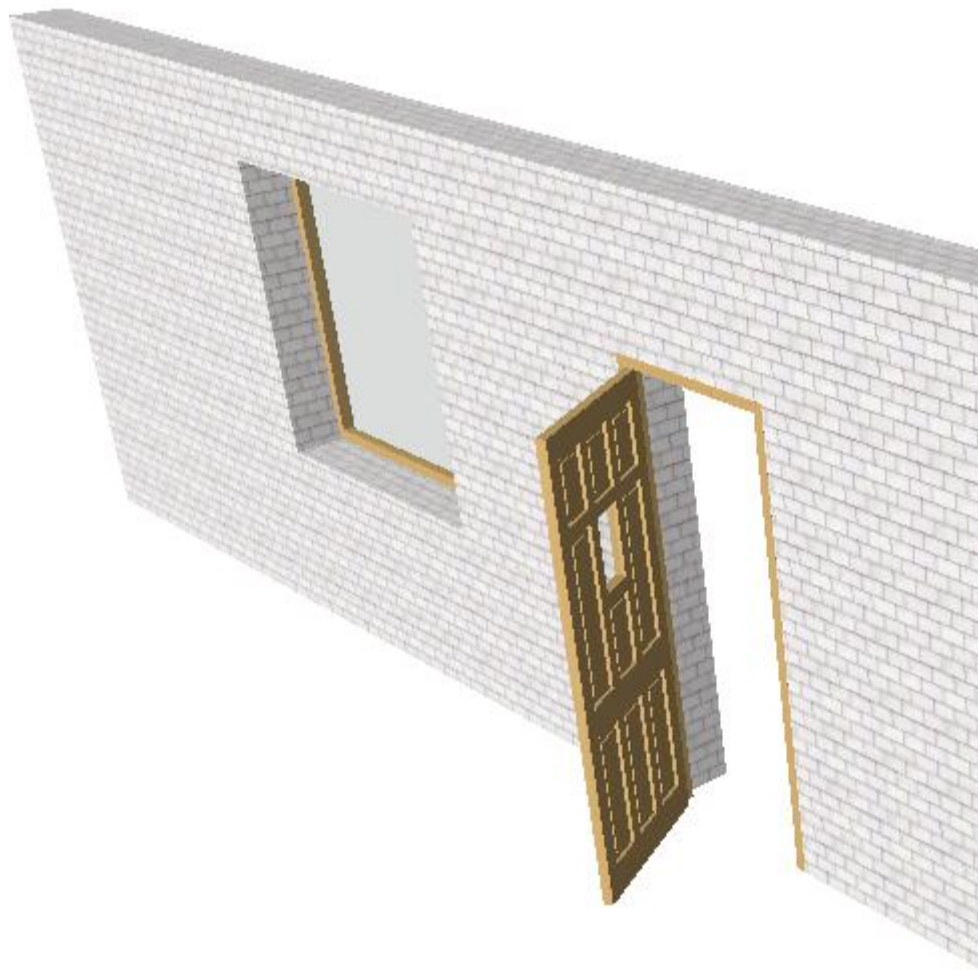
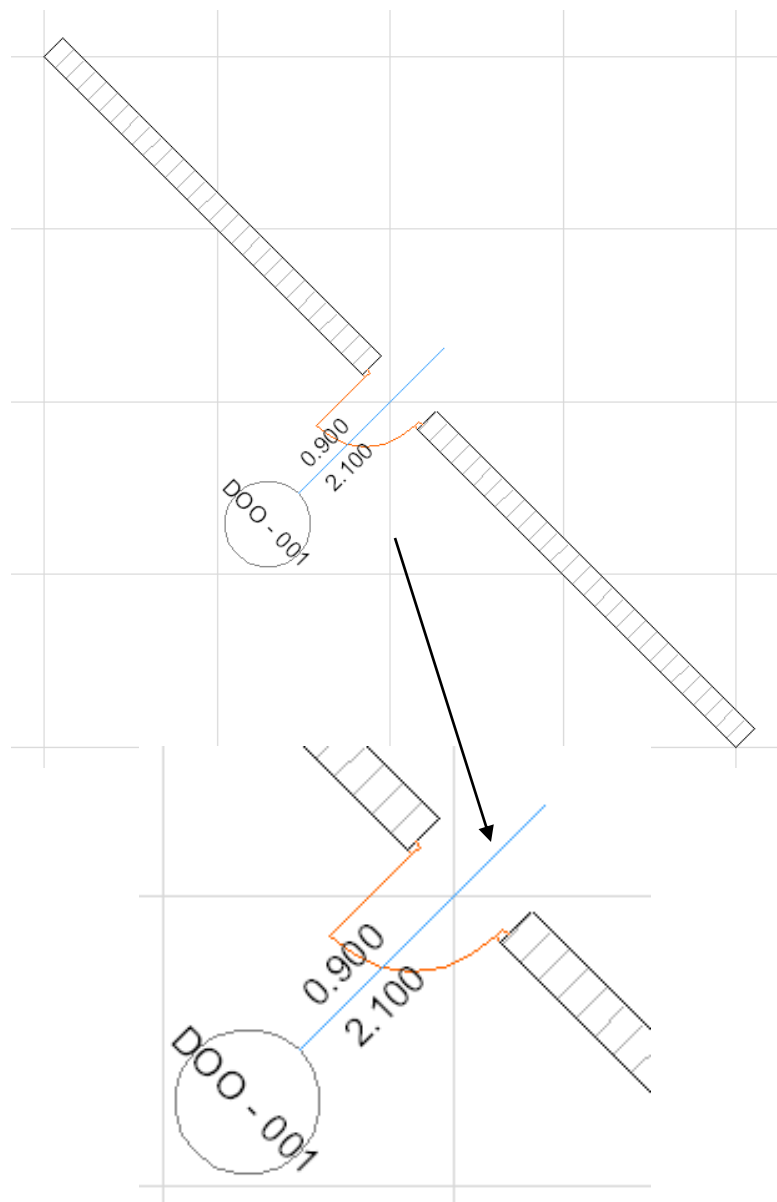

Ступенице

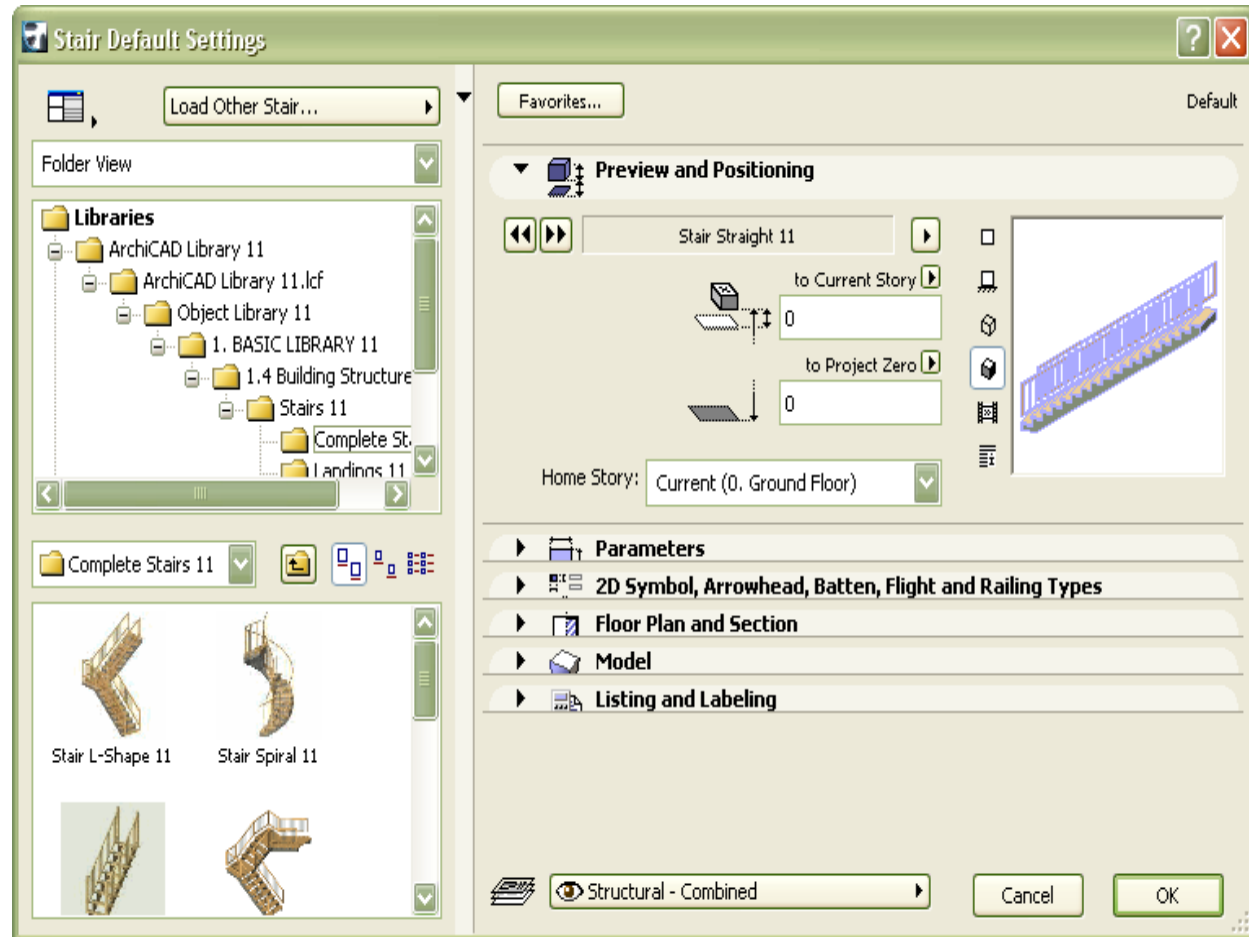

Ступенице

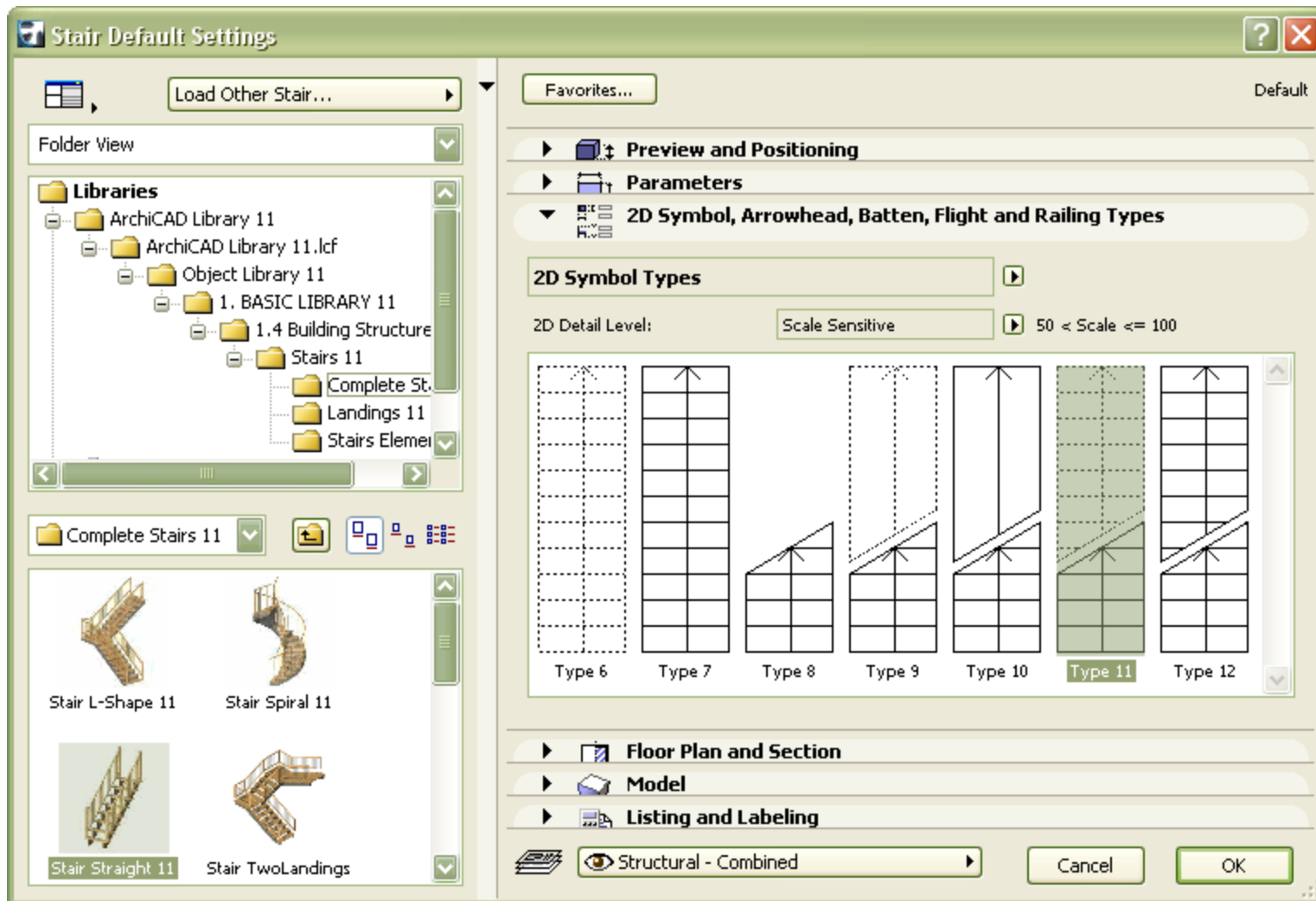

Ступенице

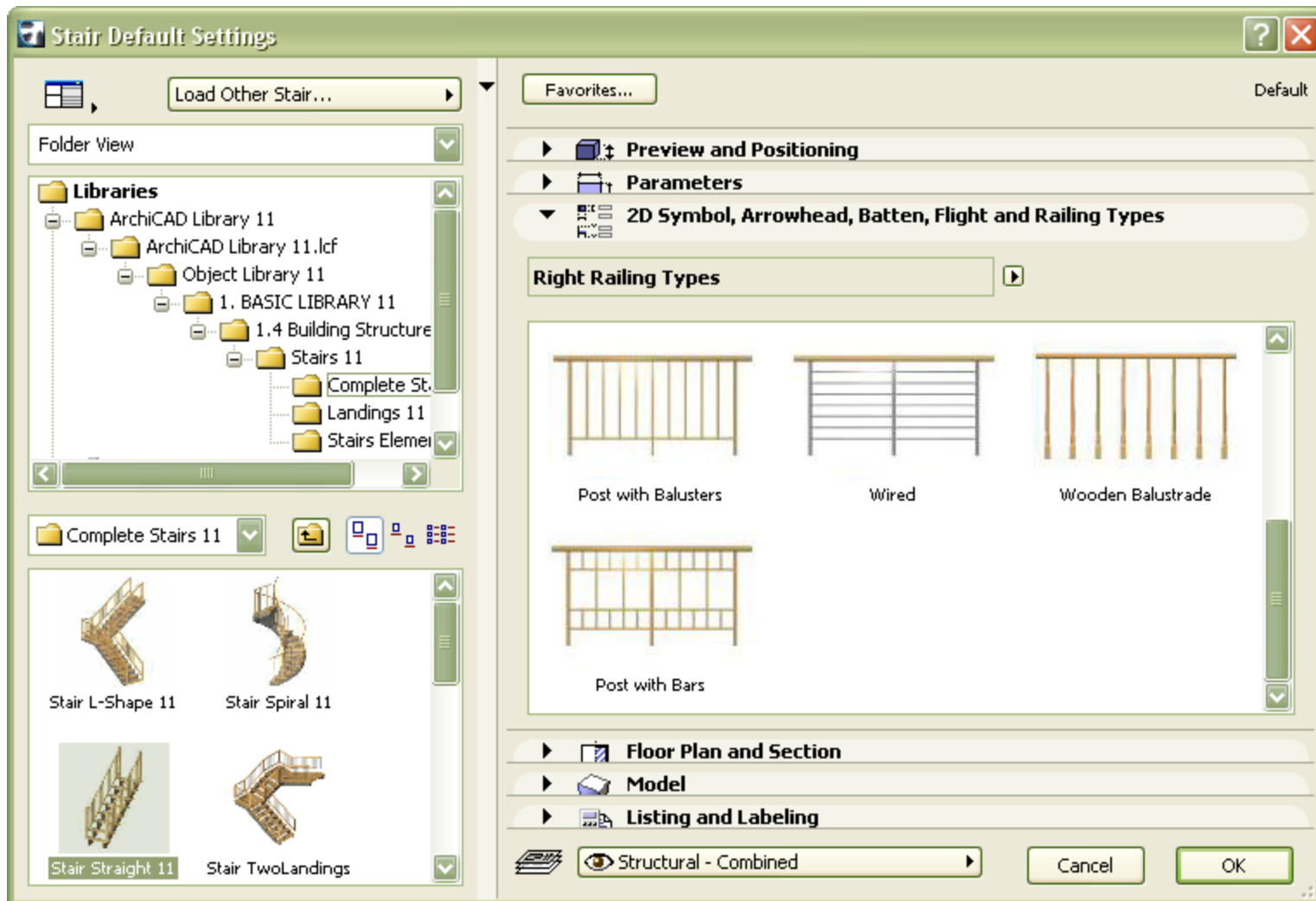

Ступенице

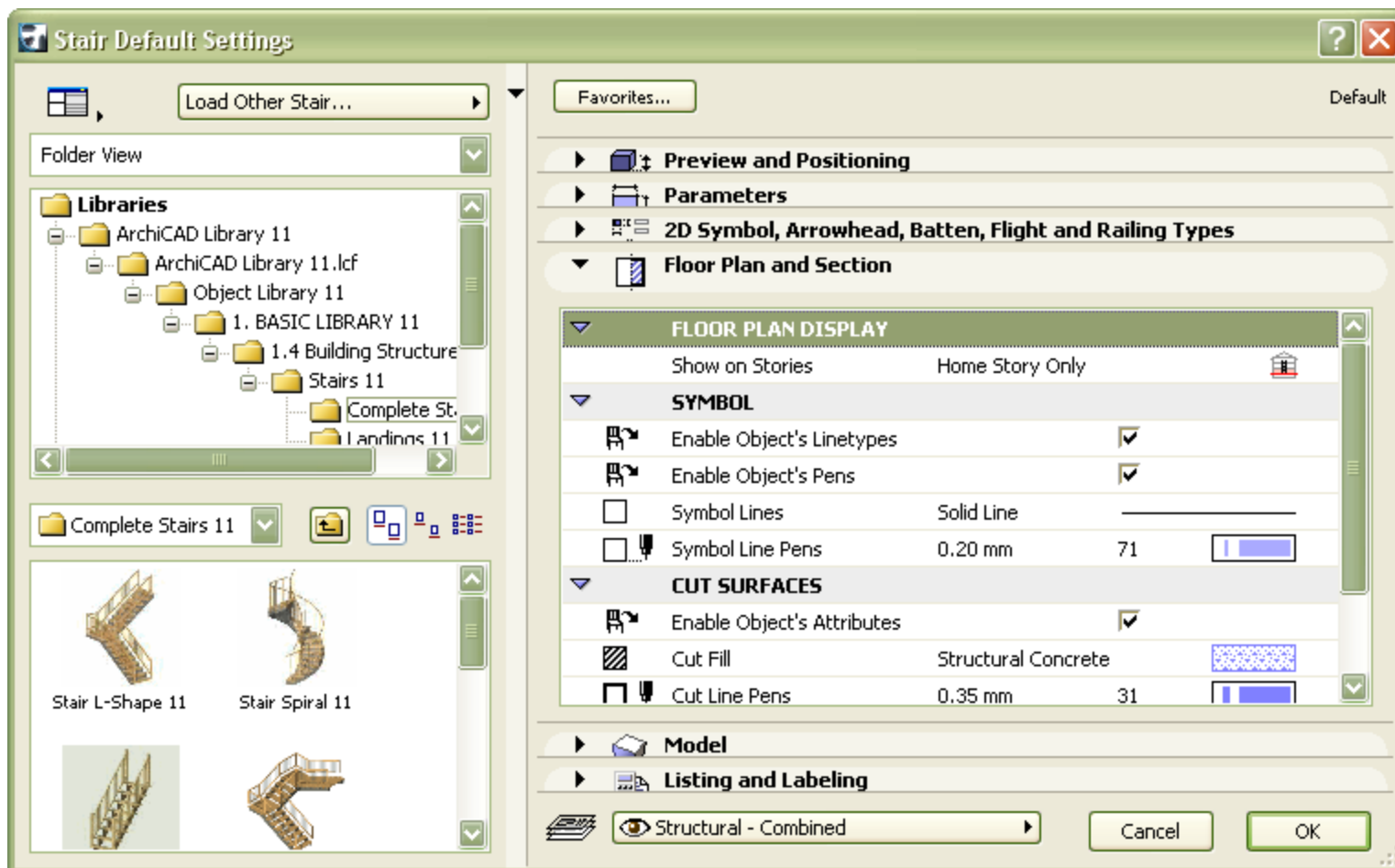

Ступенице

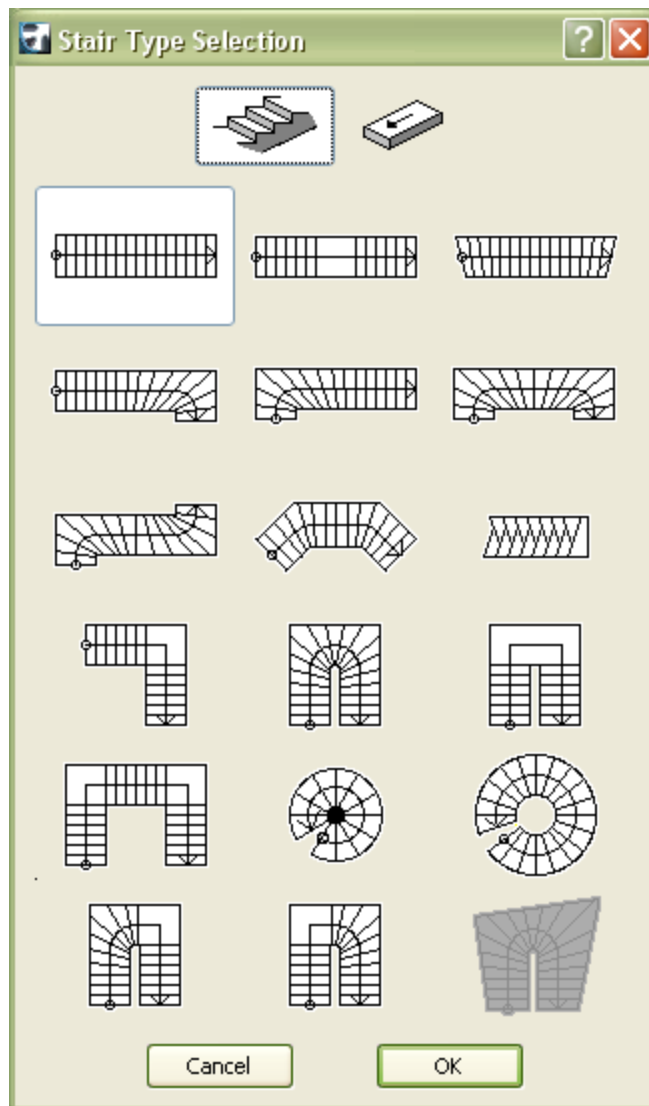

Ступенице

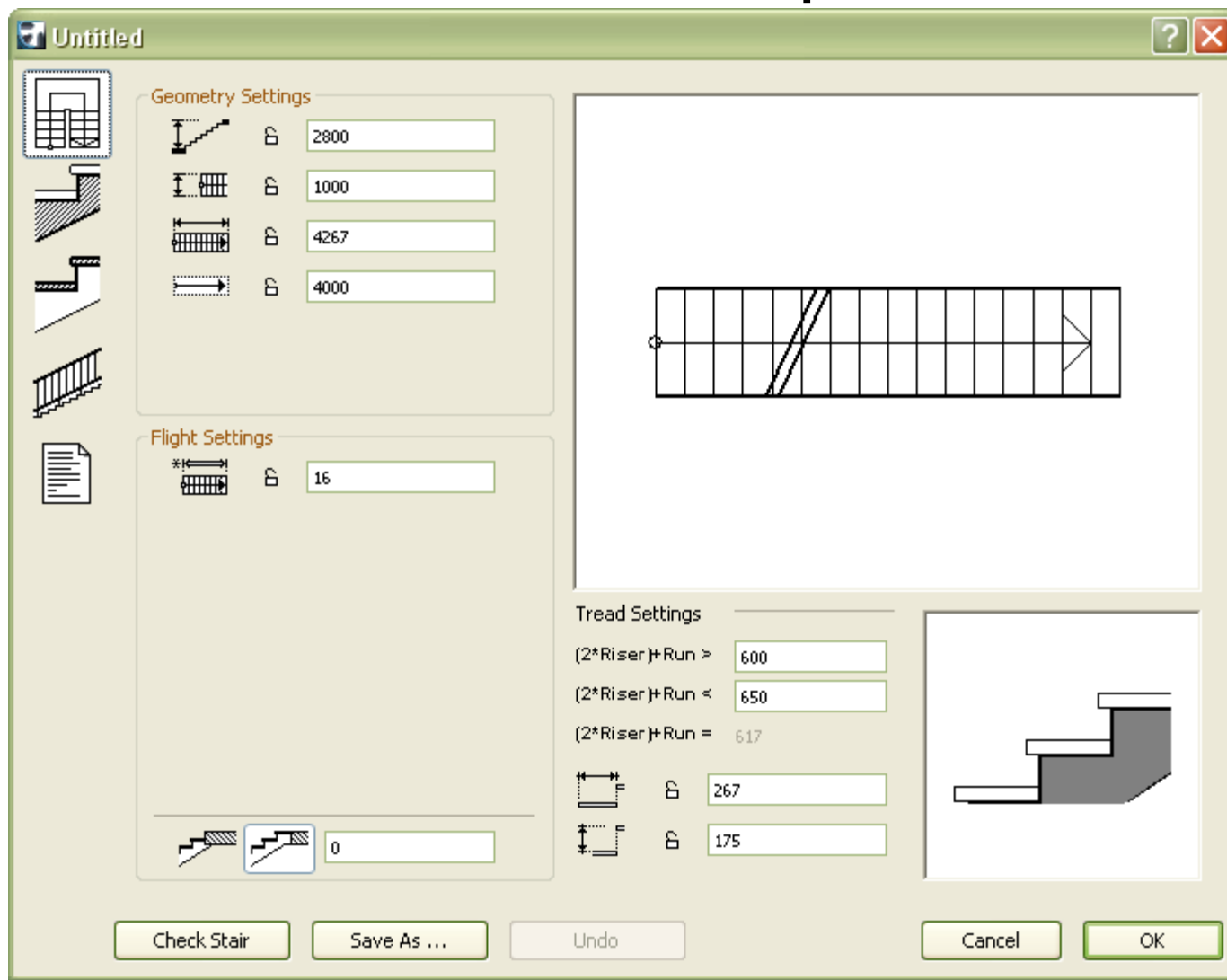

Ступенице

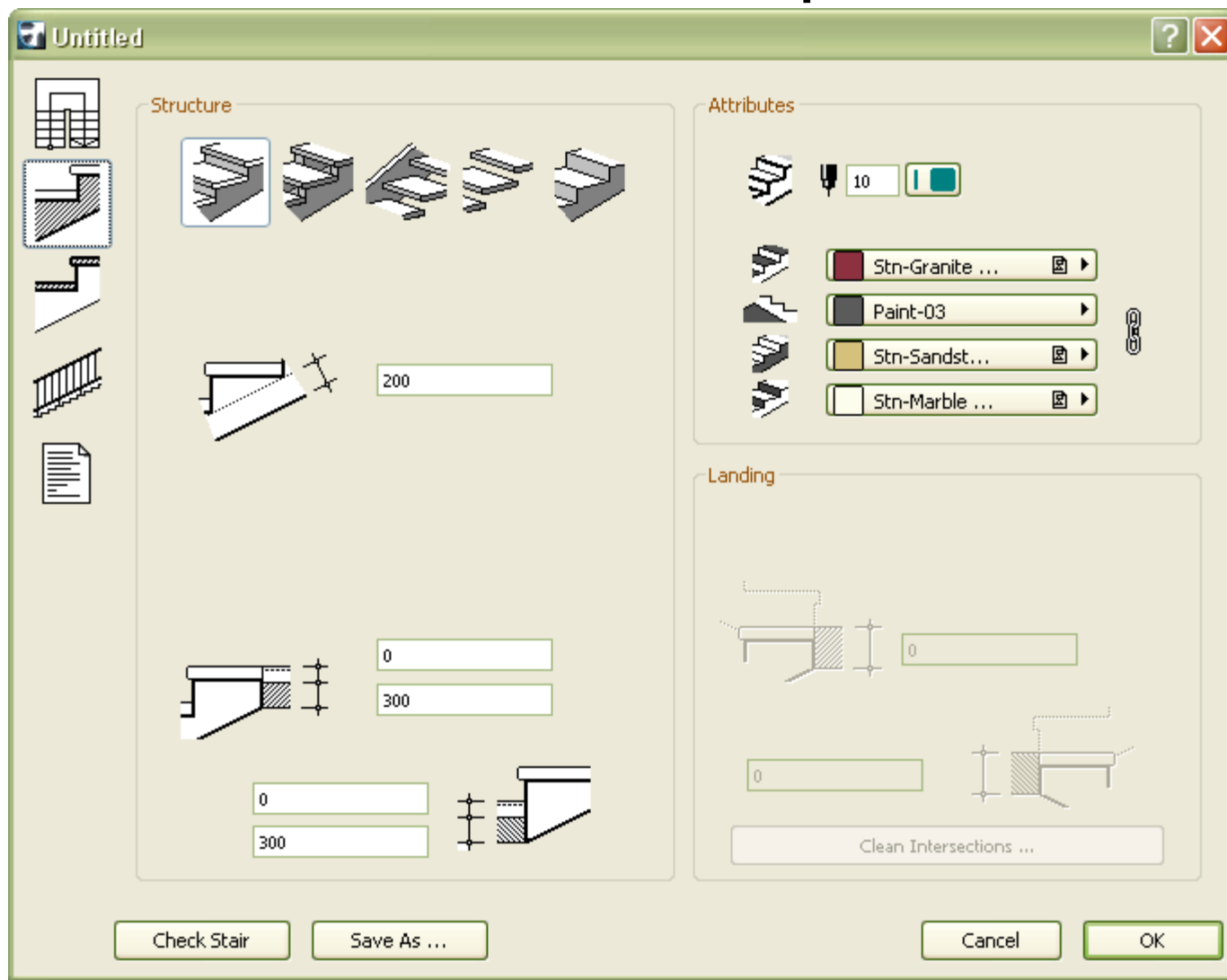

Степенице

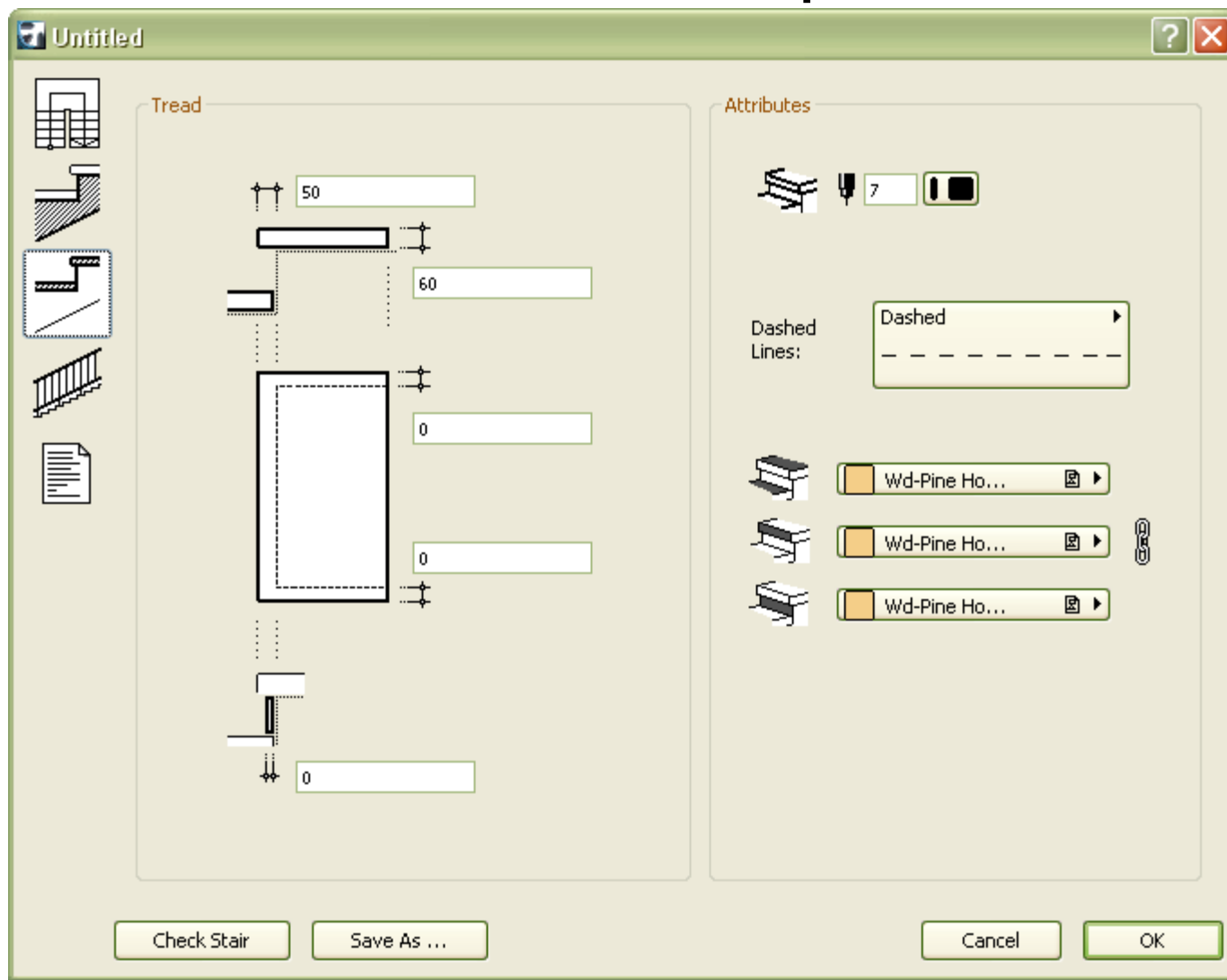

Ступенице

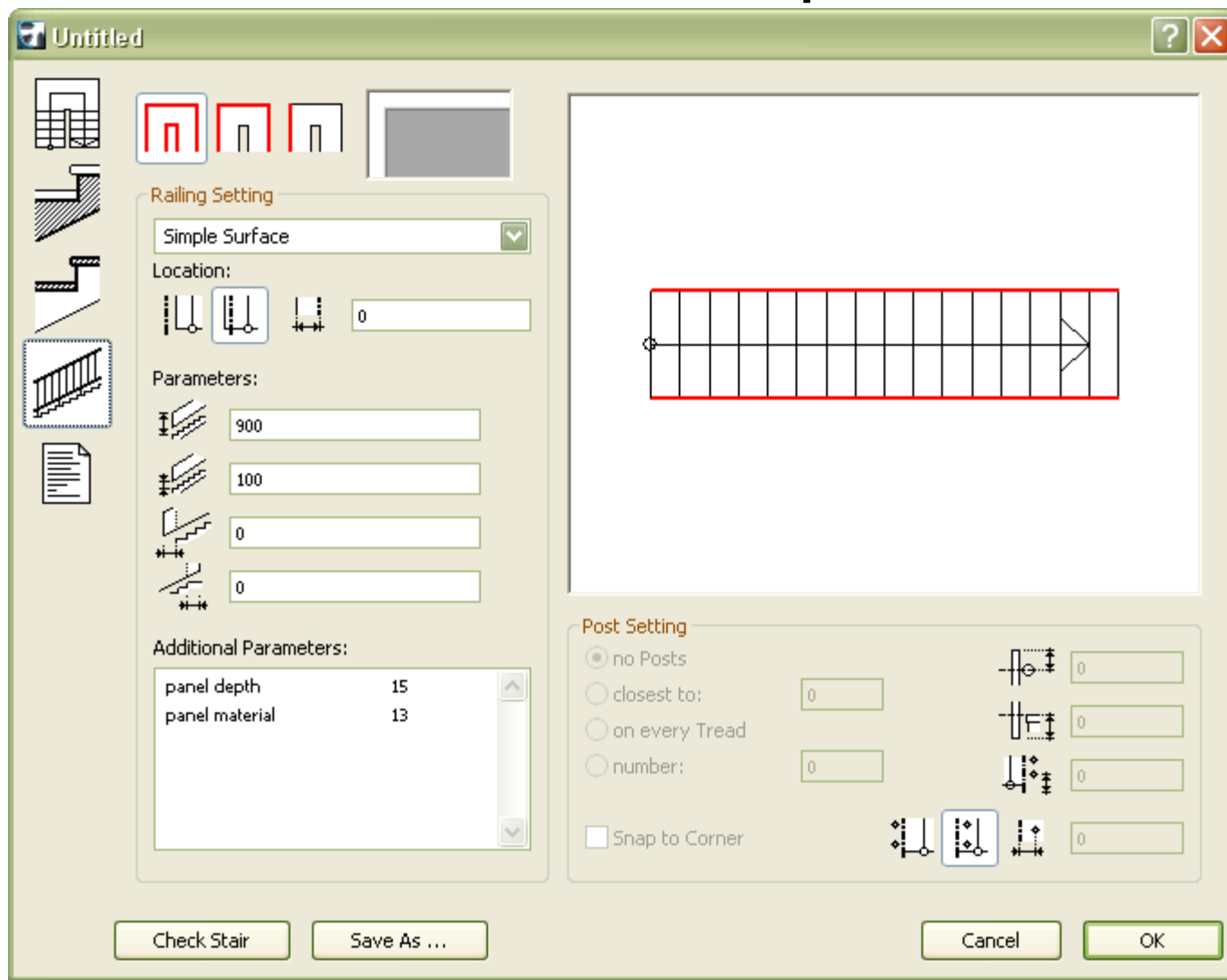

Ступенице

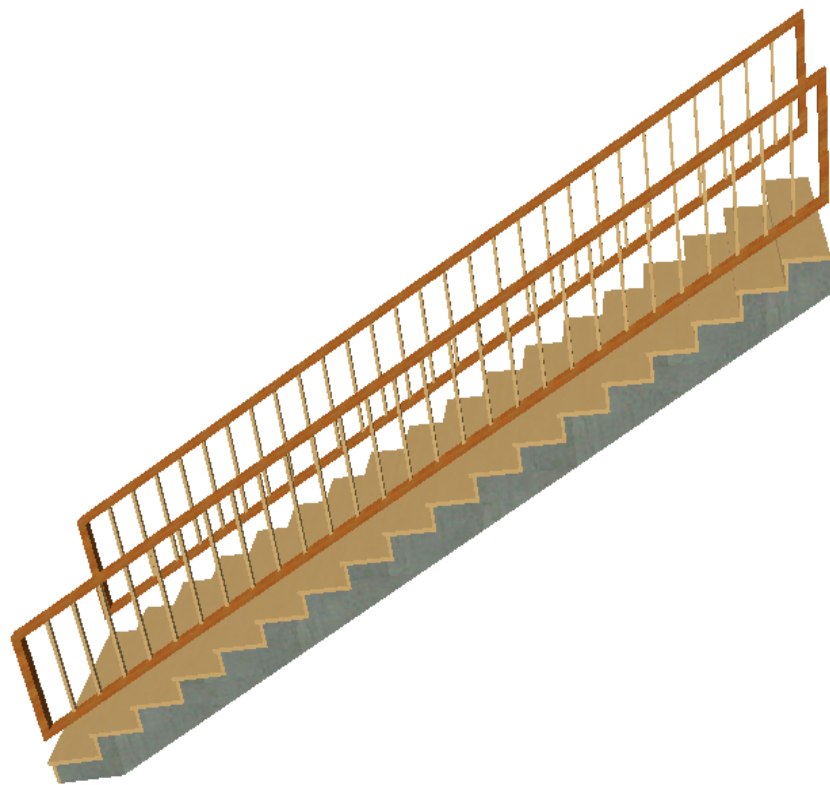

+

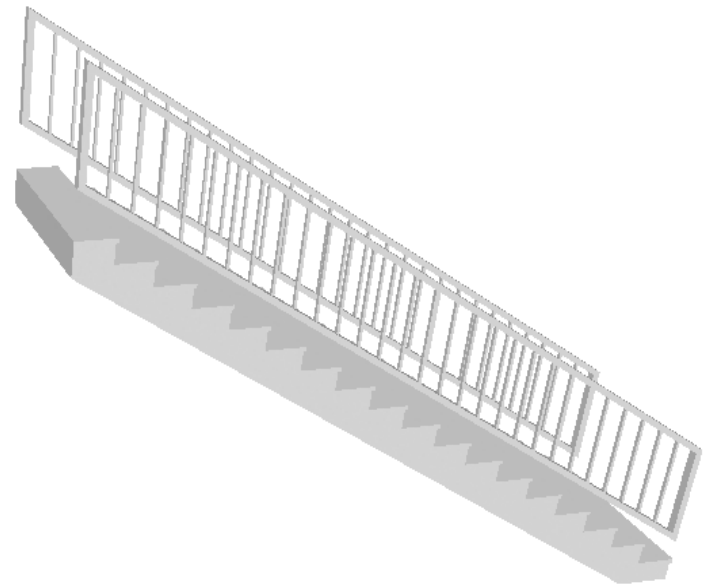

Ограде

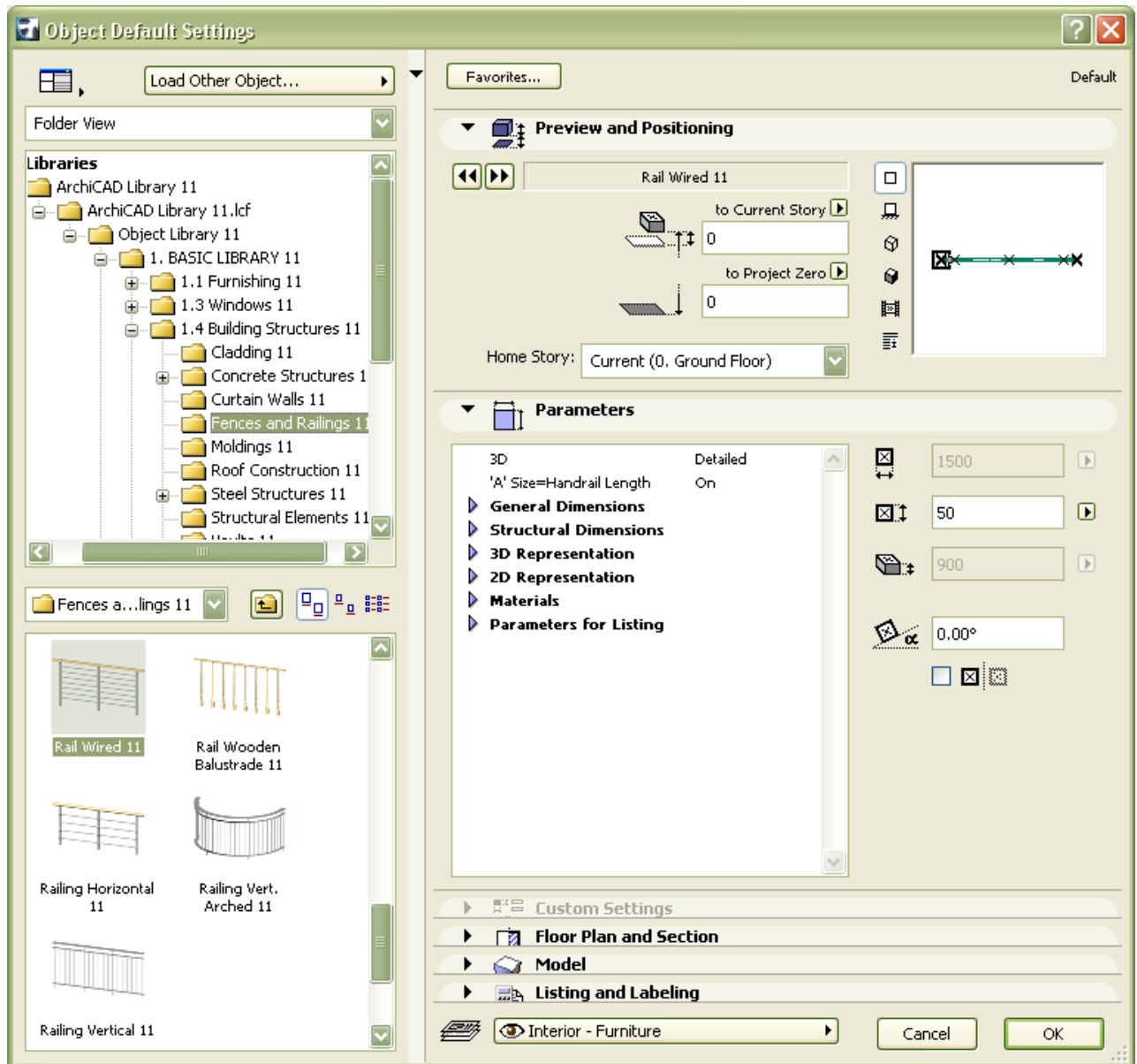

Ограде

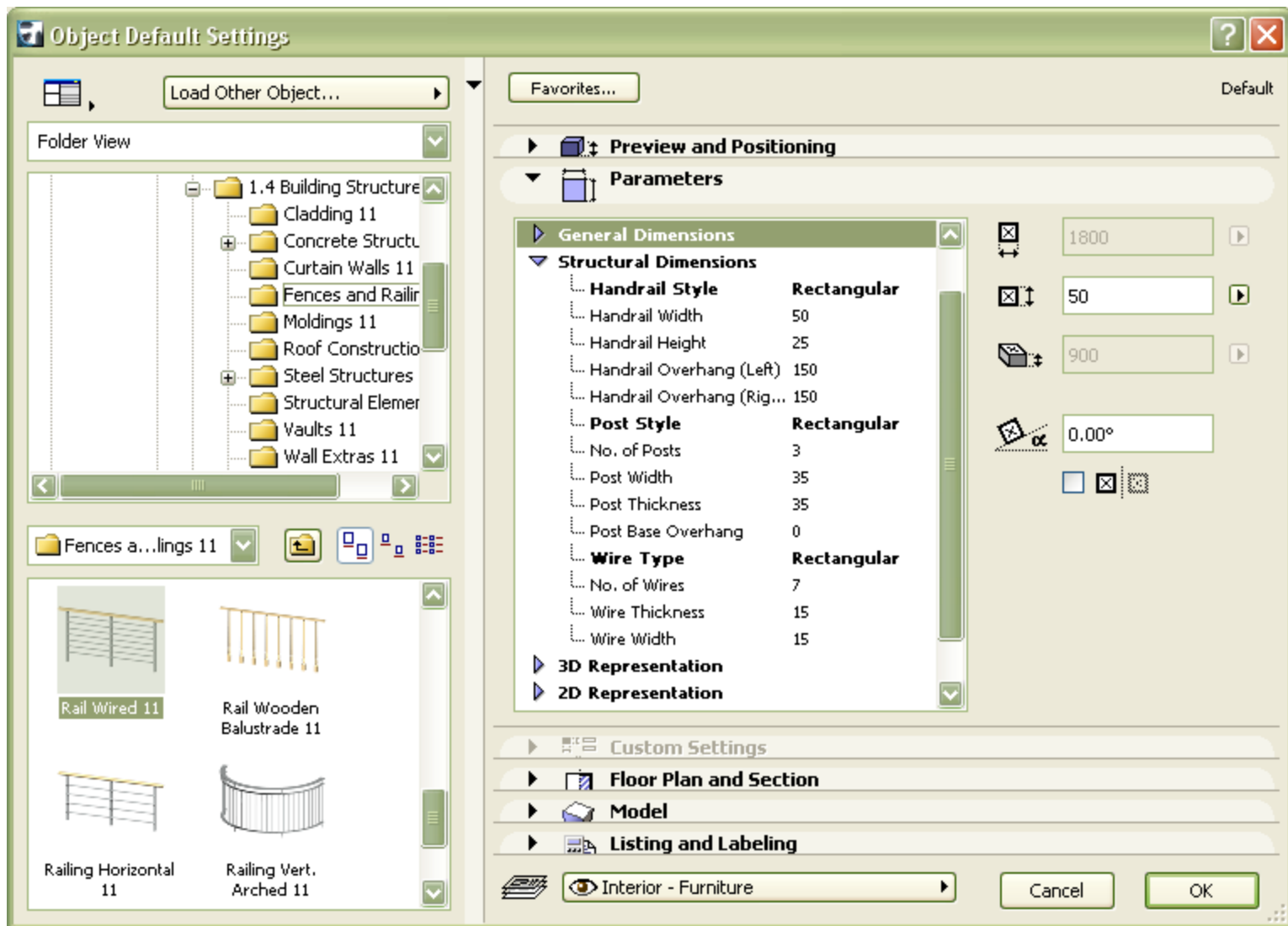

Ограде

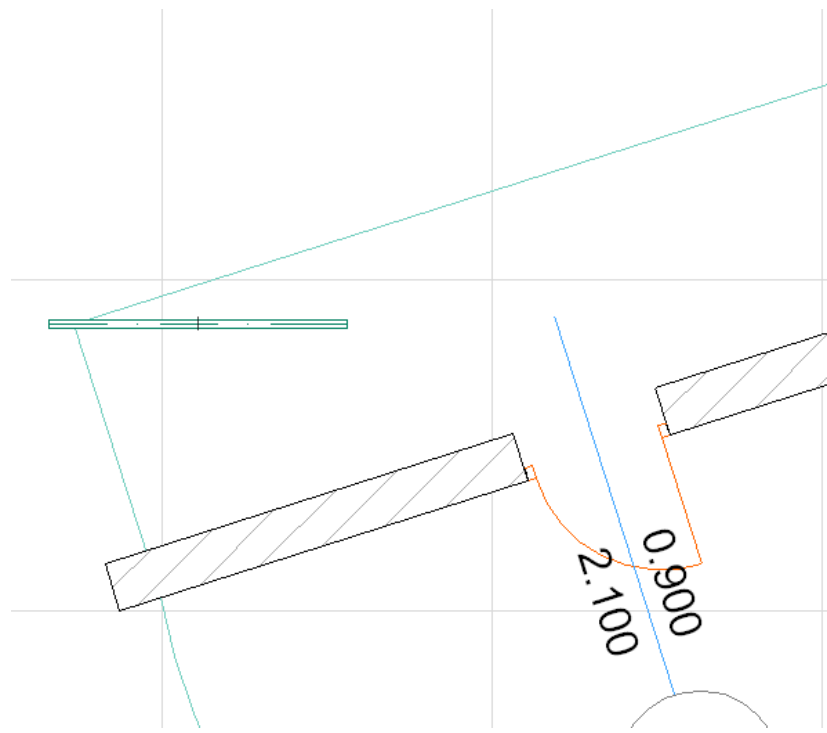
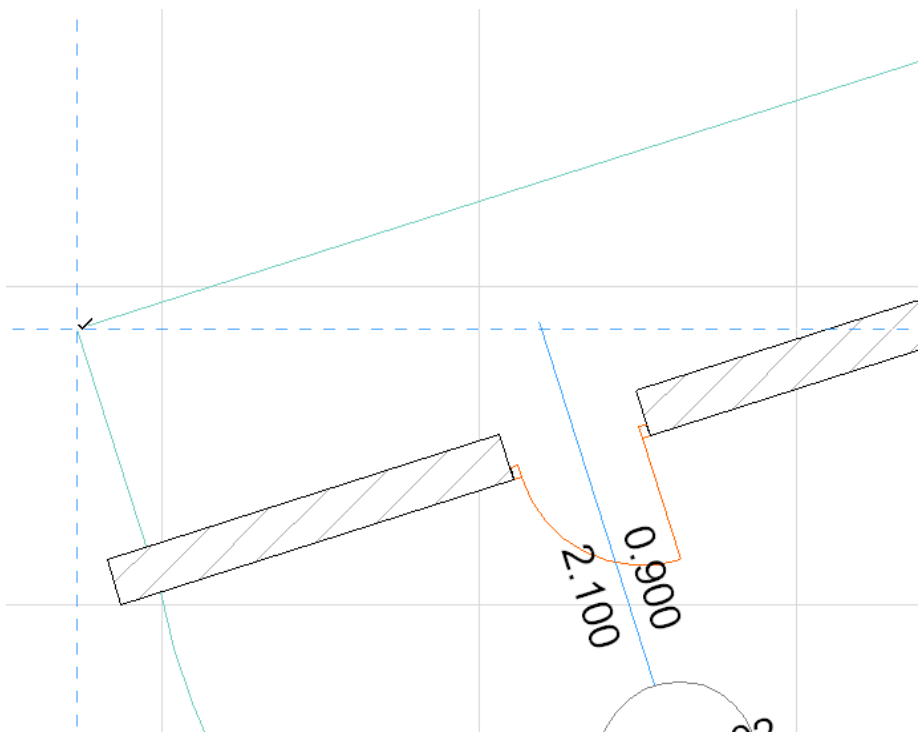

Ограде

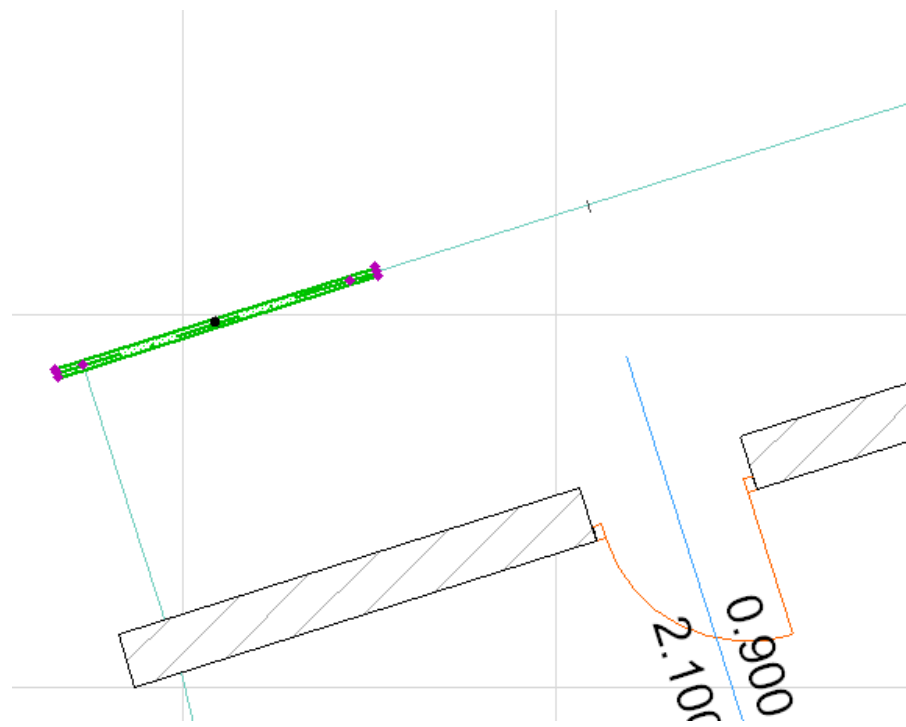
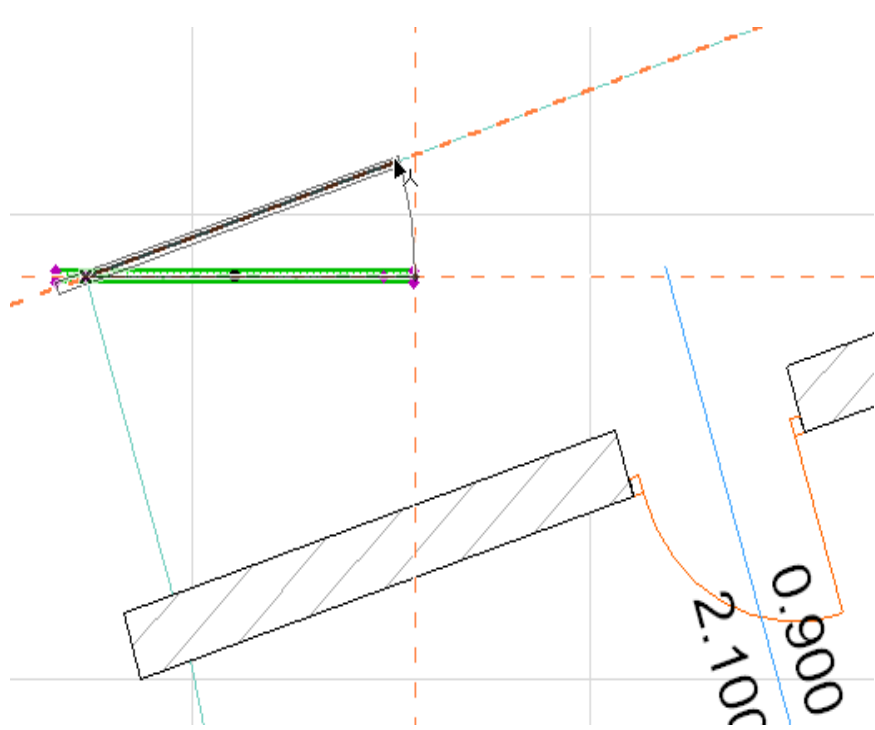

Ограде

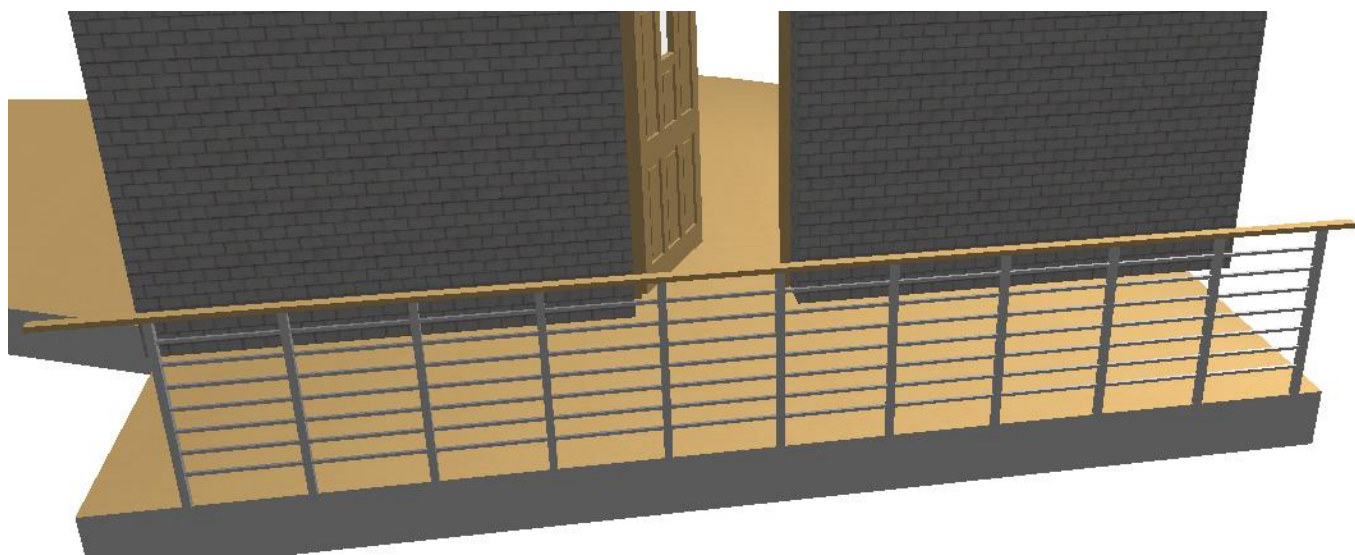
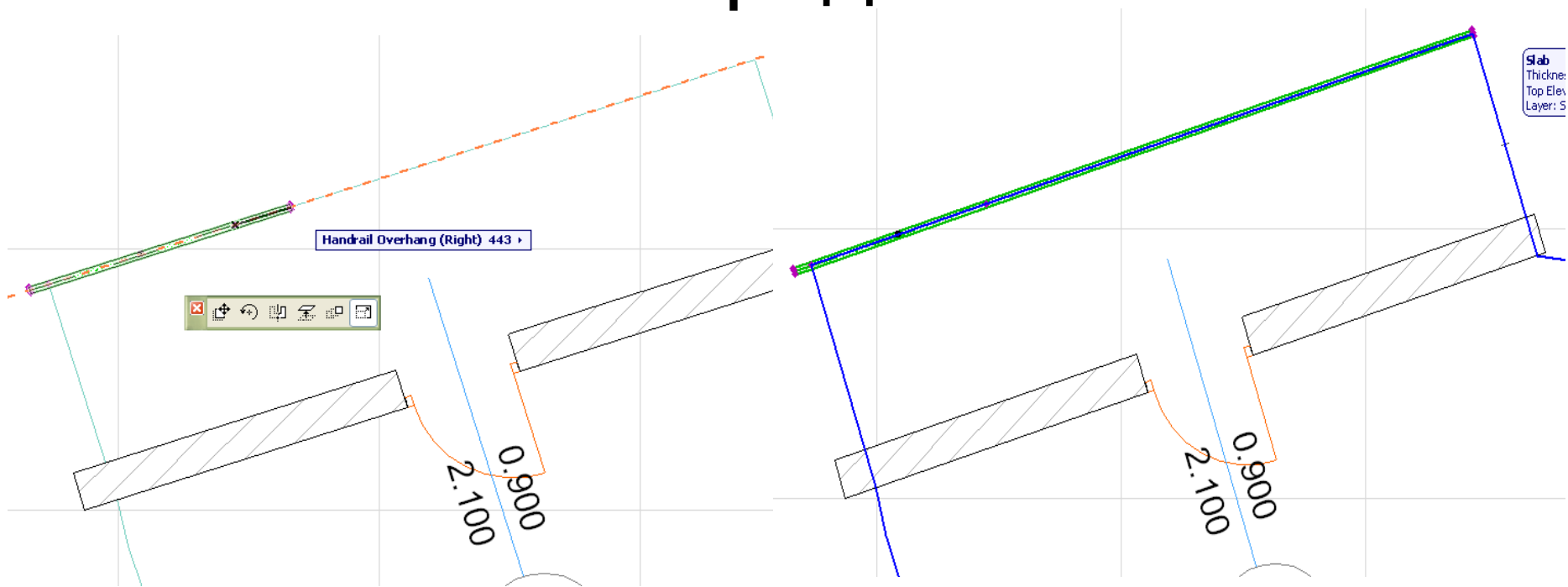

Изгледи - ELEVATIONS

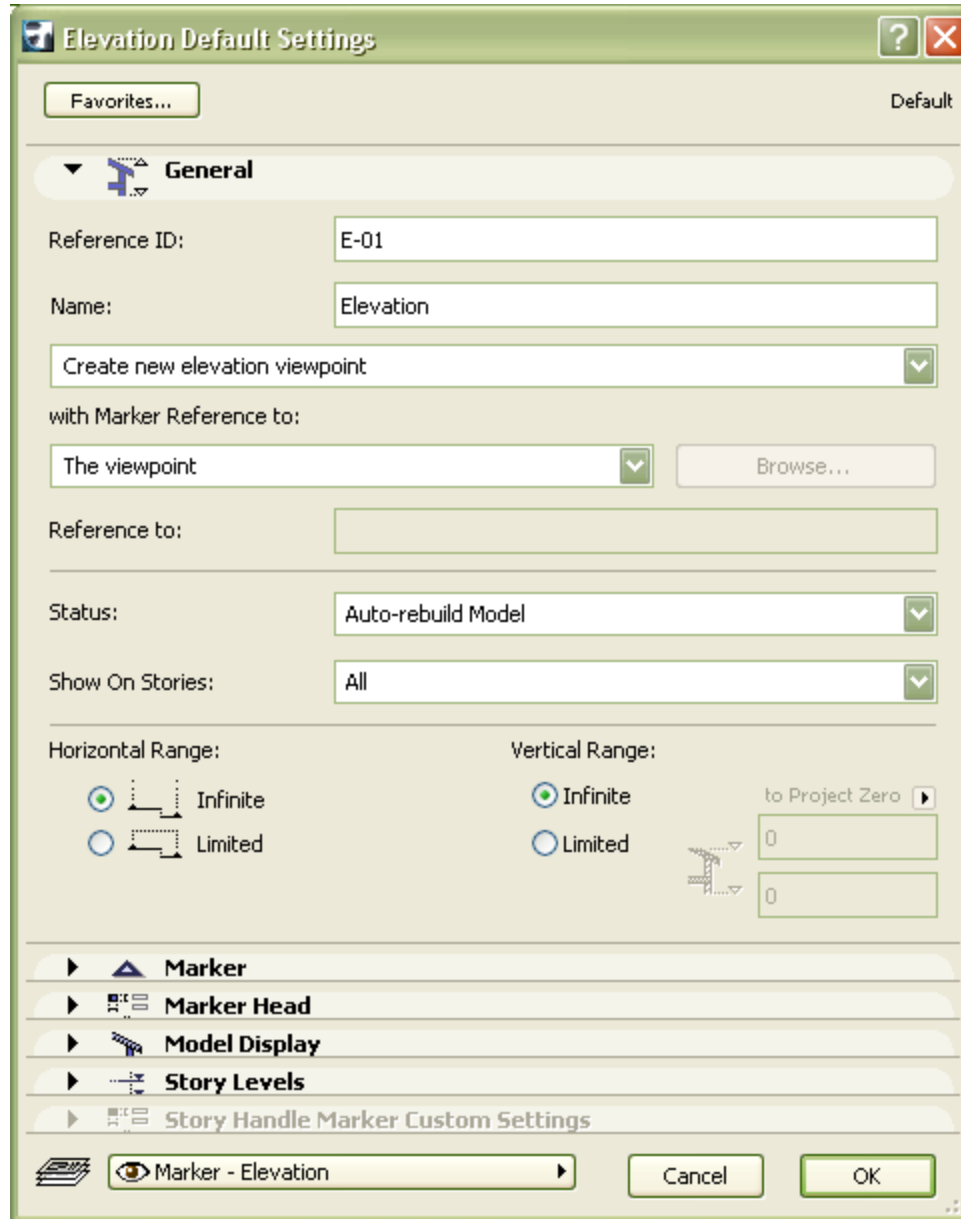
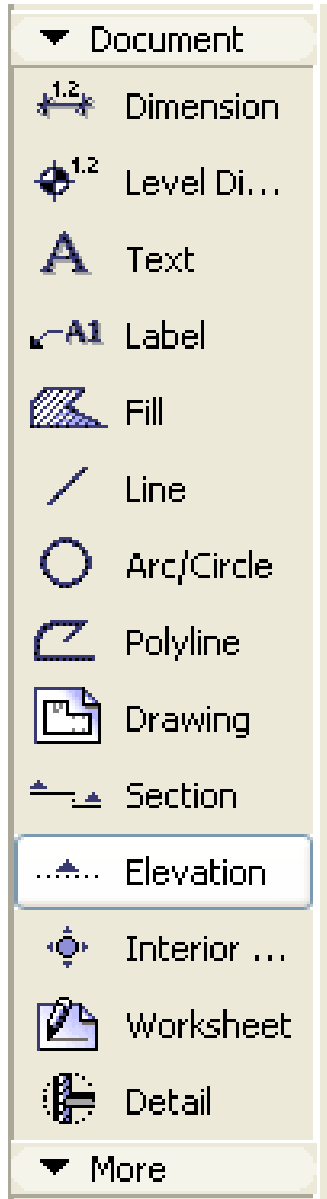

Изгледи - ELEVATIONS

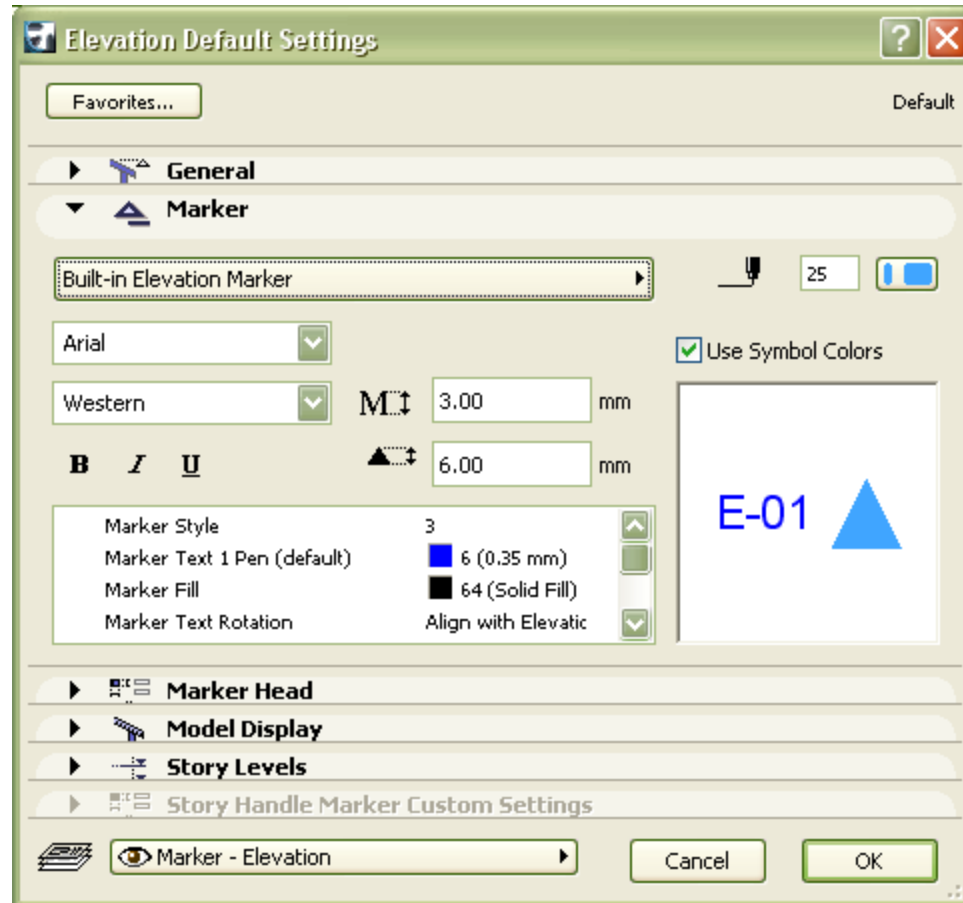

Изгледи - ELEVATIONS

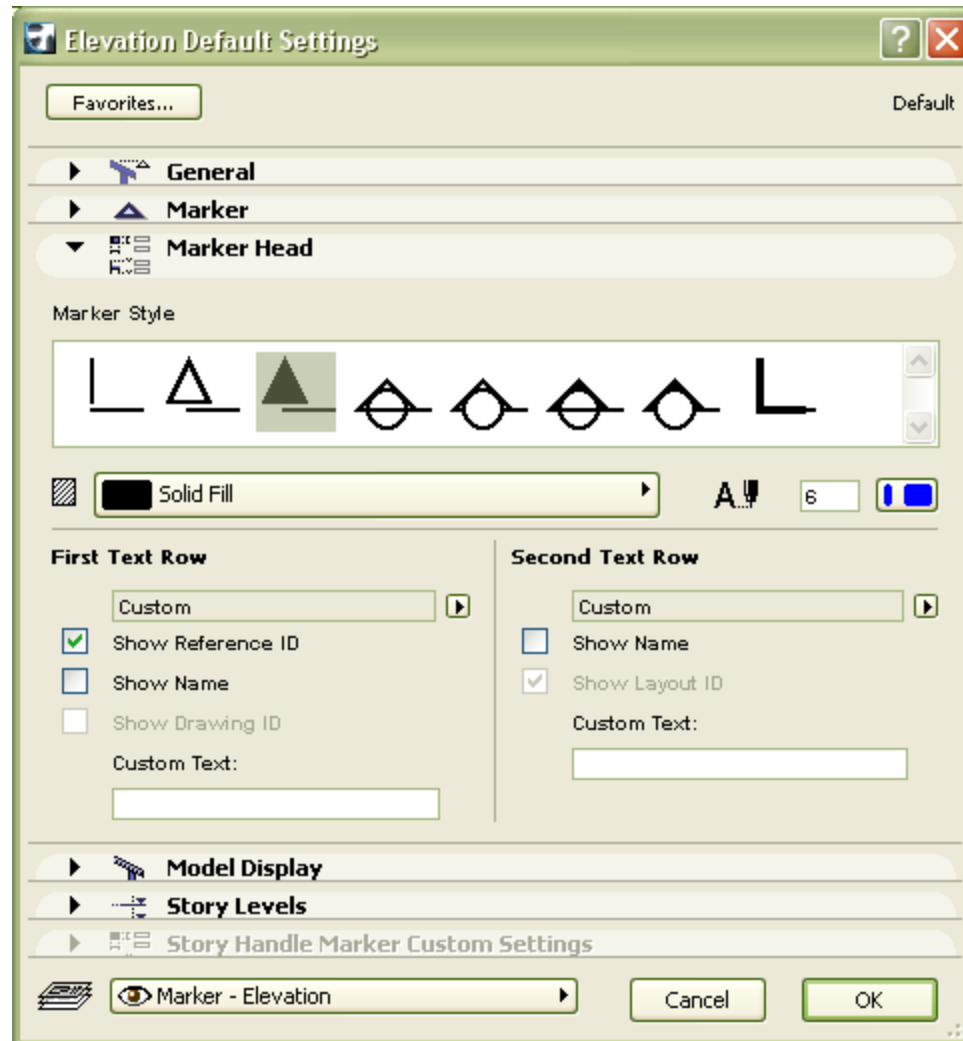

Изгледи - ELEVATIONS

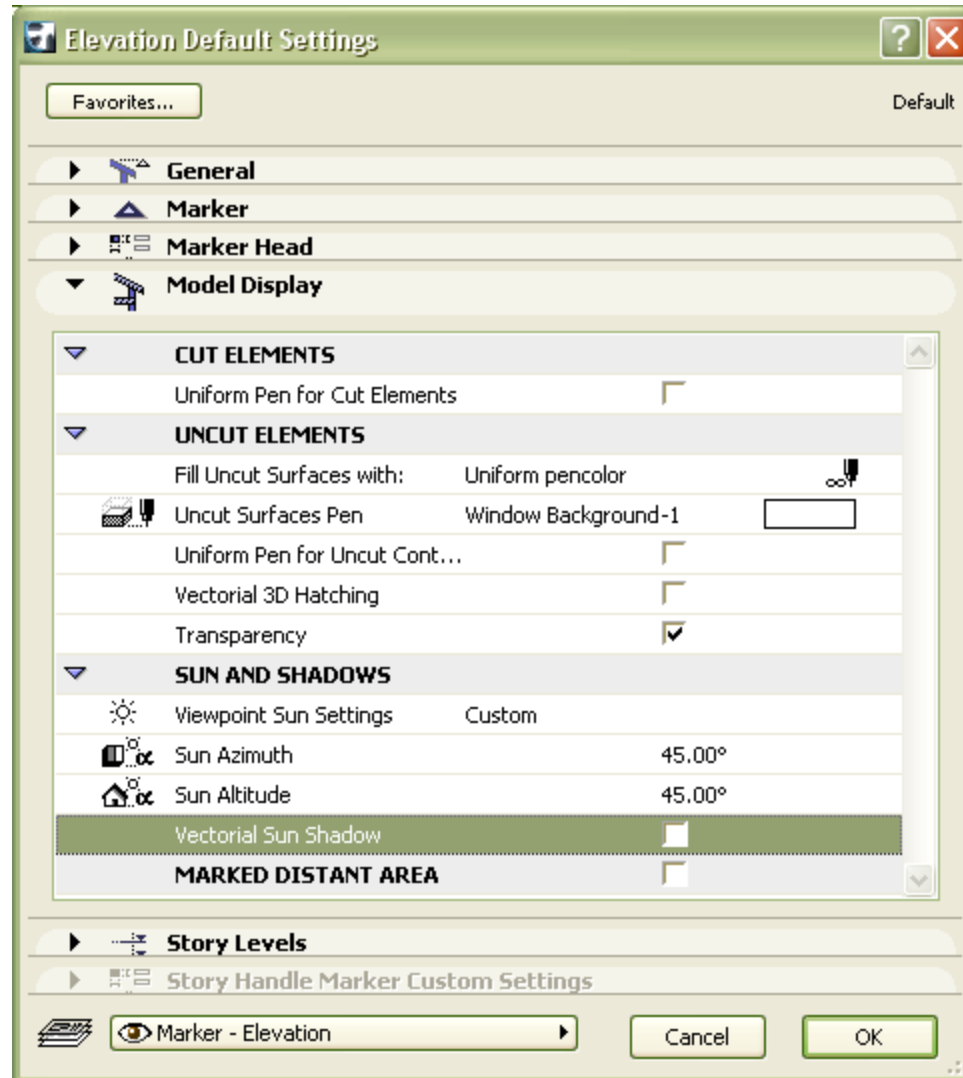

Изгледи - ELEVATIONS

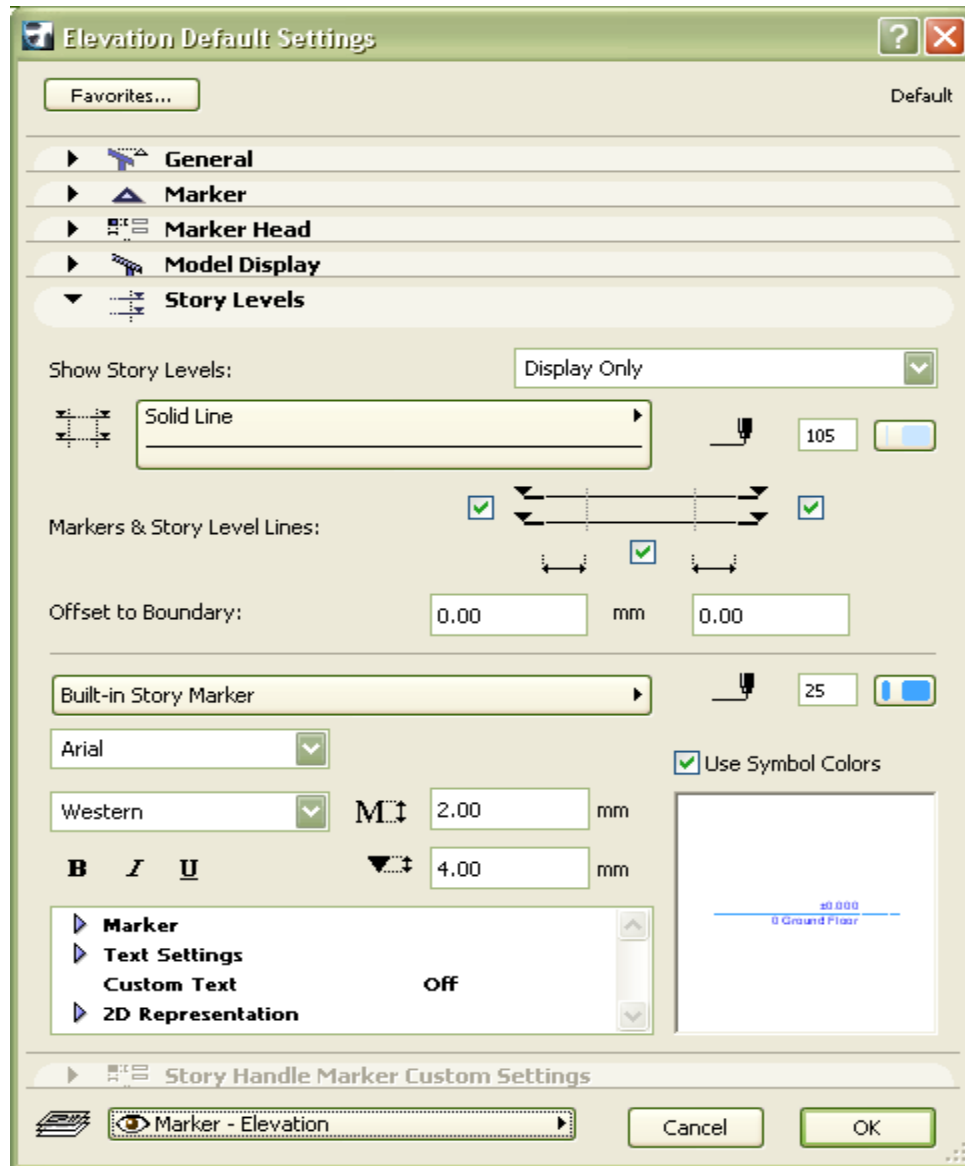

Изгледи - ELEVATIONS

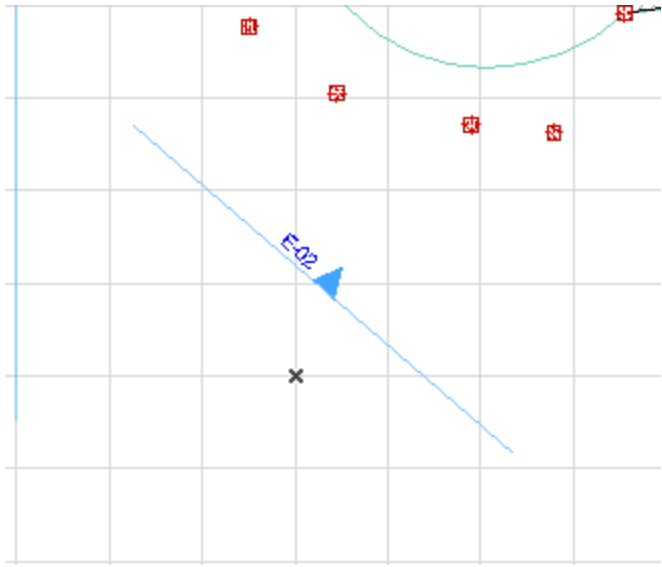
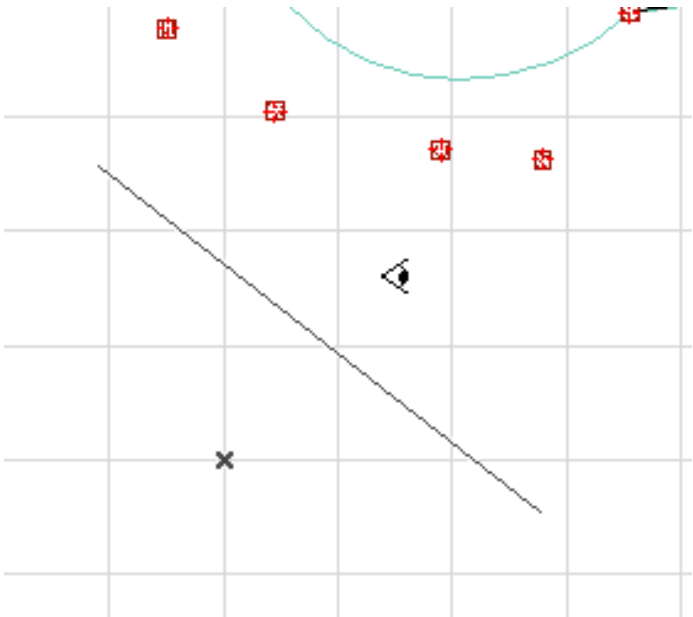
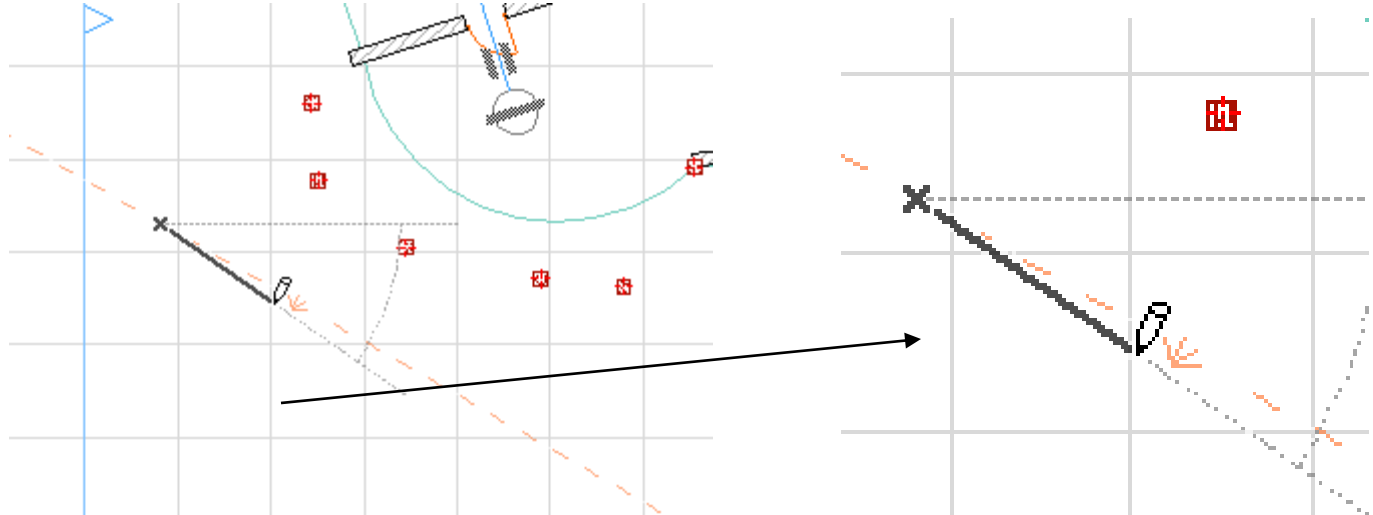
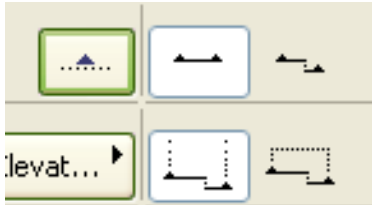

Изгледи - ELEVATIONS

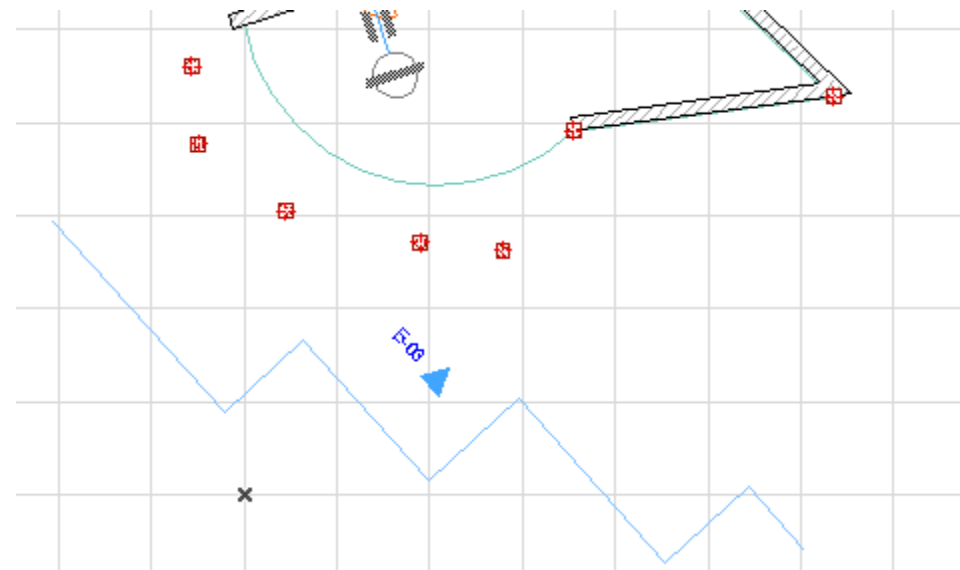
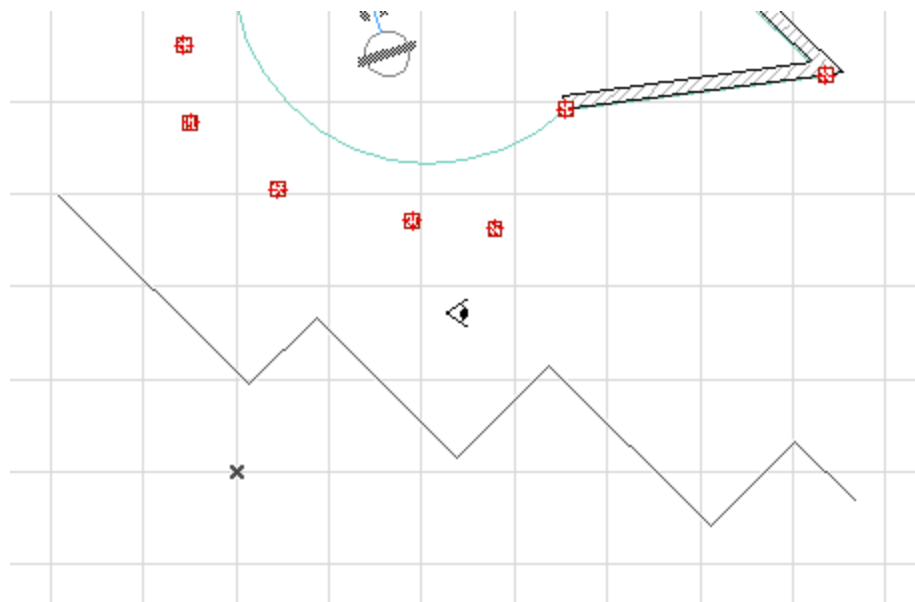
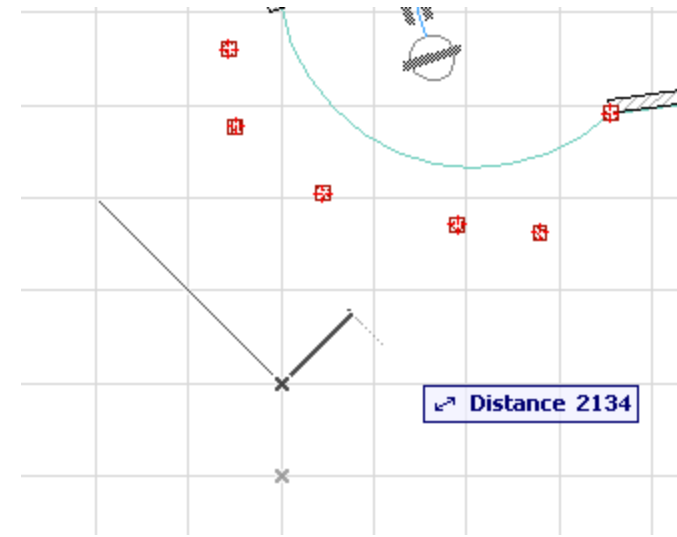
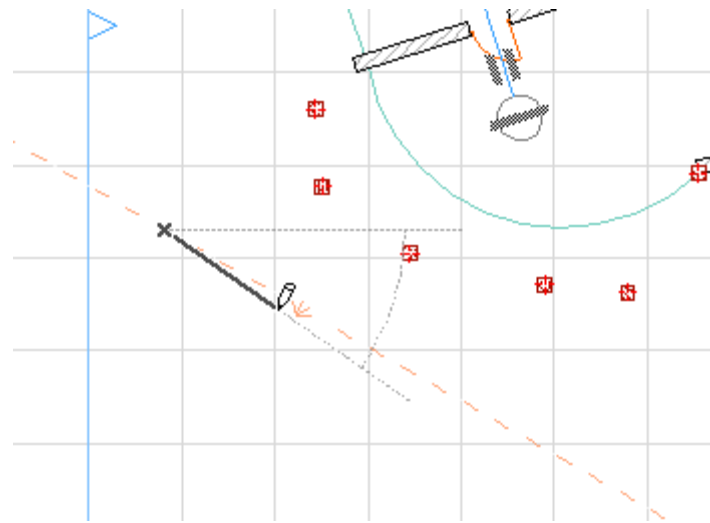
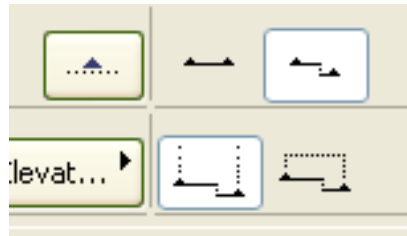

Изгледи - ELEVATIONS

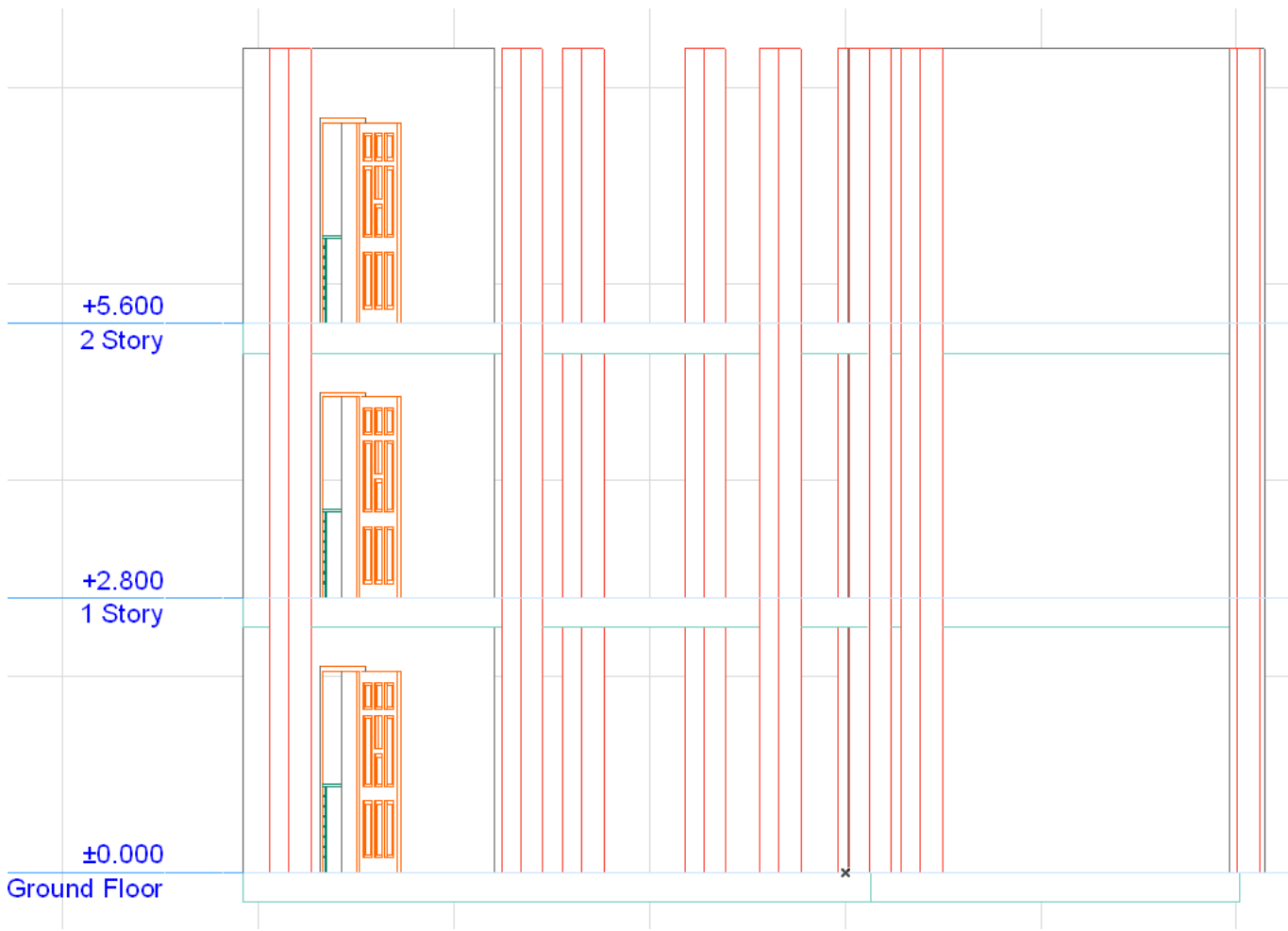
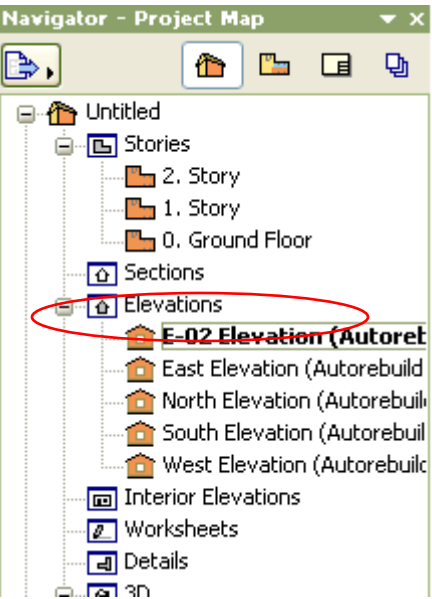

Пресеци - Sections

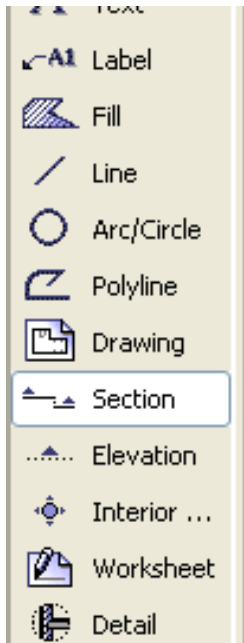

Section Default Settings [?] [X] Default

Favorites... [Default]

General

Reference ID: S-01

Name: Building Section

Create new section viewpoint [v]

with Marker Reference to:

The viewpoint [v] [Browse...]

Reference to: []

Status: Auto-rebuild Model [v]

Show On Stories: All [v]

Horizontal Range: Vertical Range:

Infinite Infinite to Project Zero [v]

Limited Limited [v] 0

Zero Depth [v] 0

▶ **Marker**

▶ **Marker Head**

▶ **Model Display**

▶ **Story Levels**

▶ **Story Handle Marker Custom Settings**

[v] Marker - Section [v] [Cancel] [OK]

Пресеци - Sections

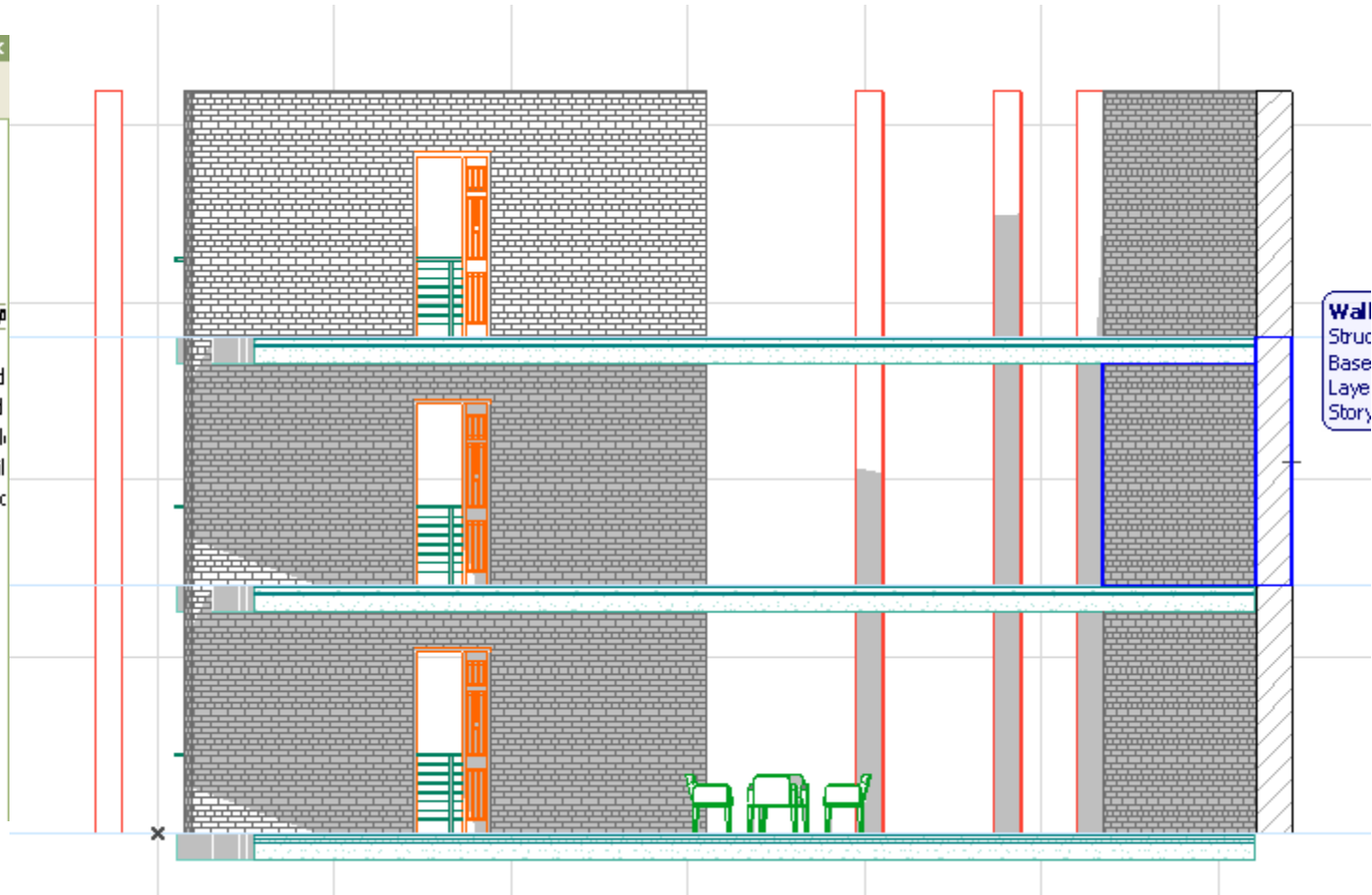
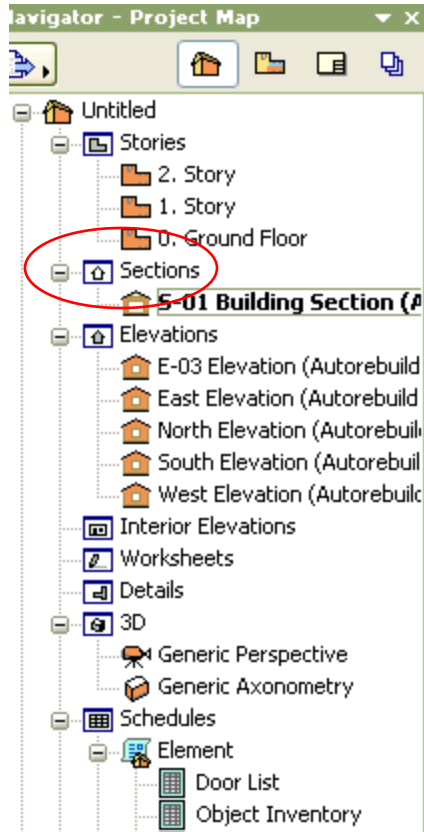

Унутрашњи изгледи – interior elevations

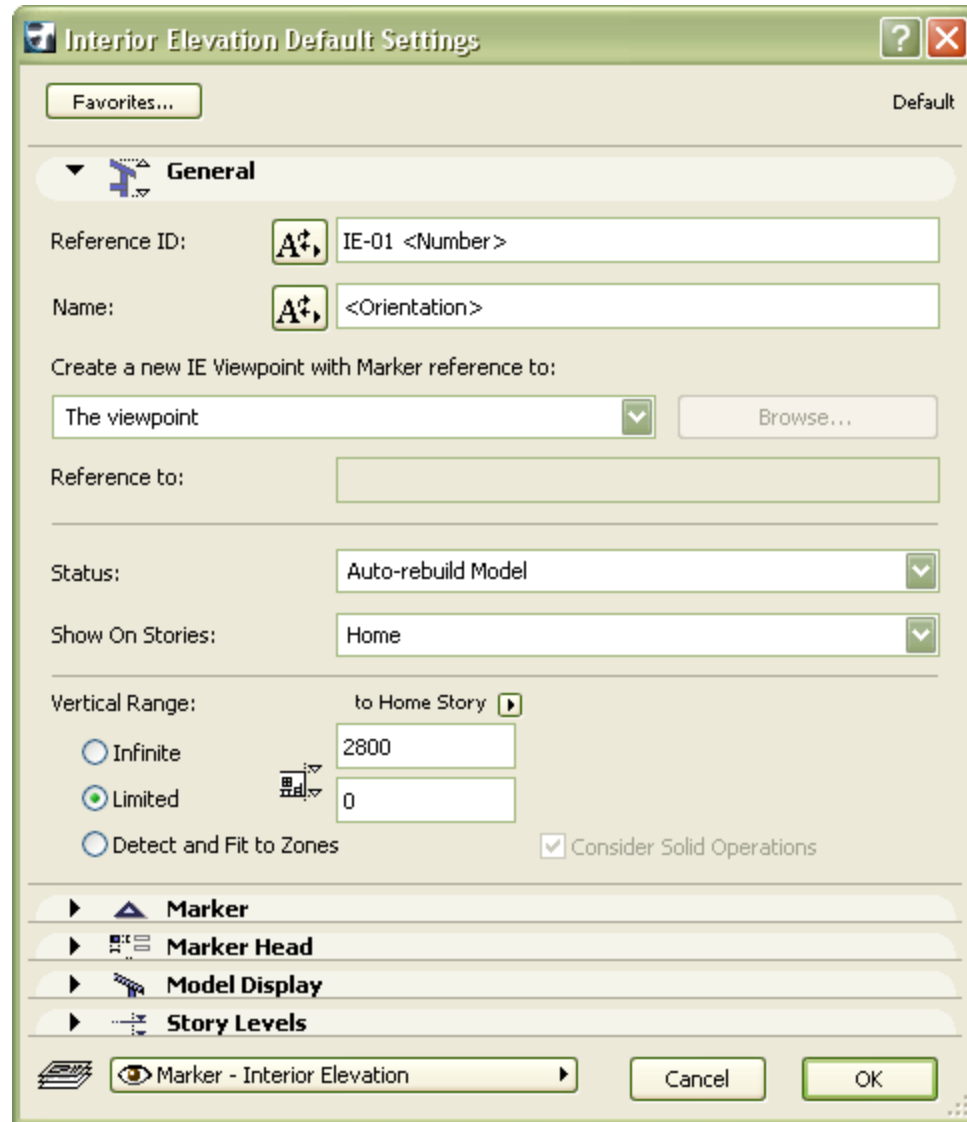
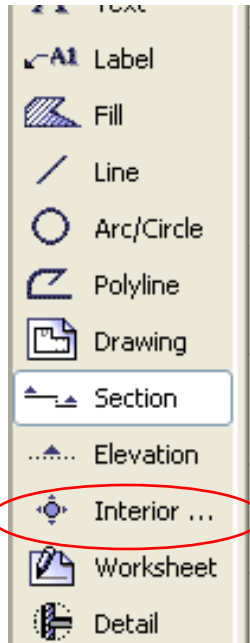

Унутрашњи изгледи – interior elevations

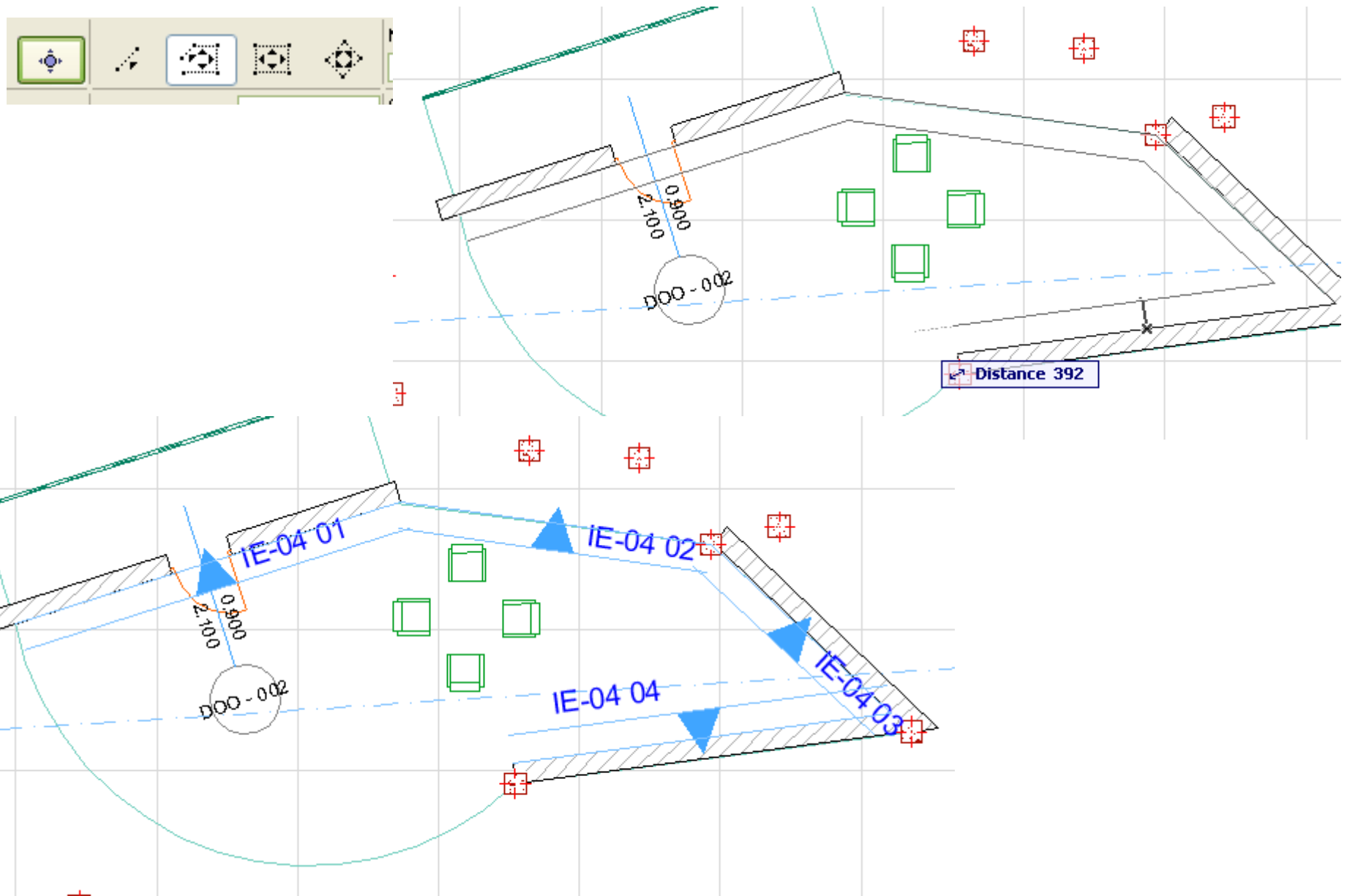

Унутрашњи изгледи – interior elevations

