

Софтвери у грађевинарству

мр Вуле Алексић, проф.

Предавање IV

Профил менаџер

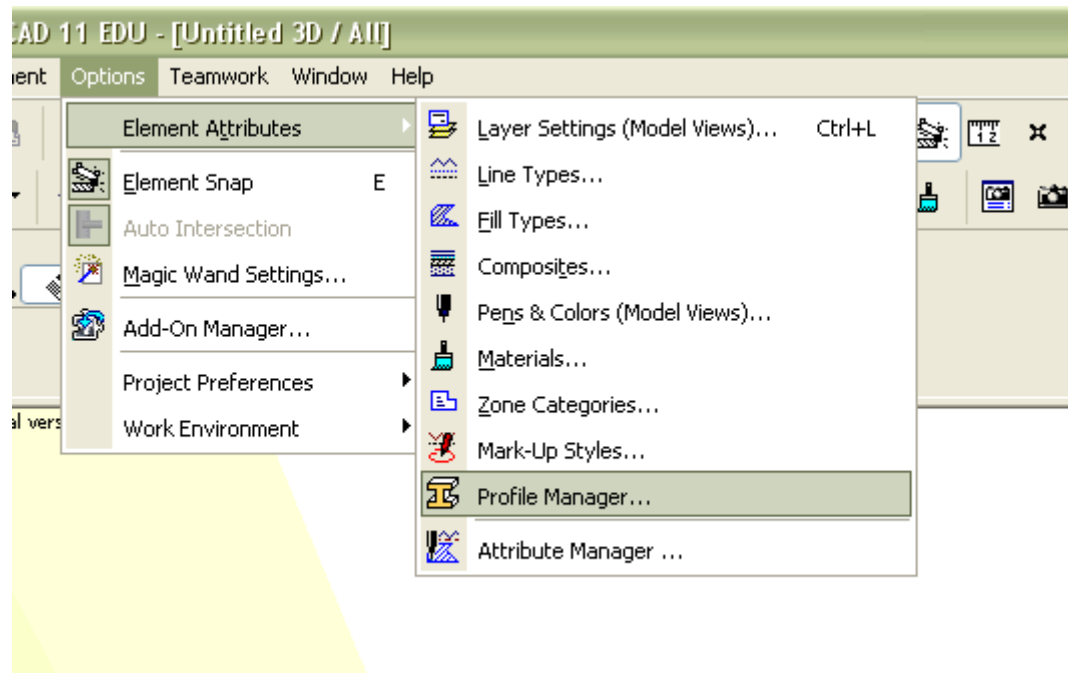

Профил менаџер

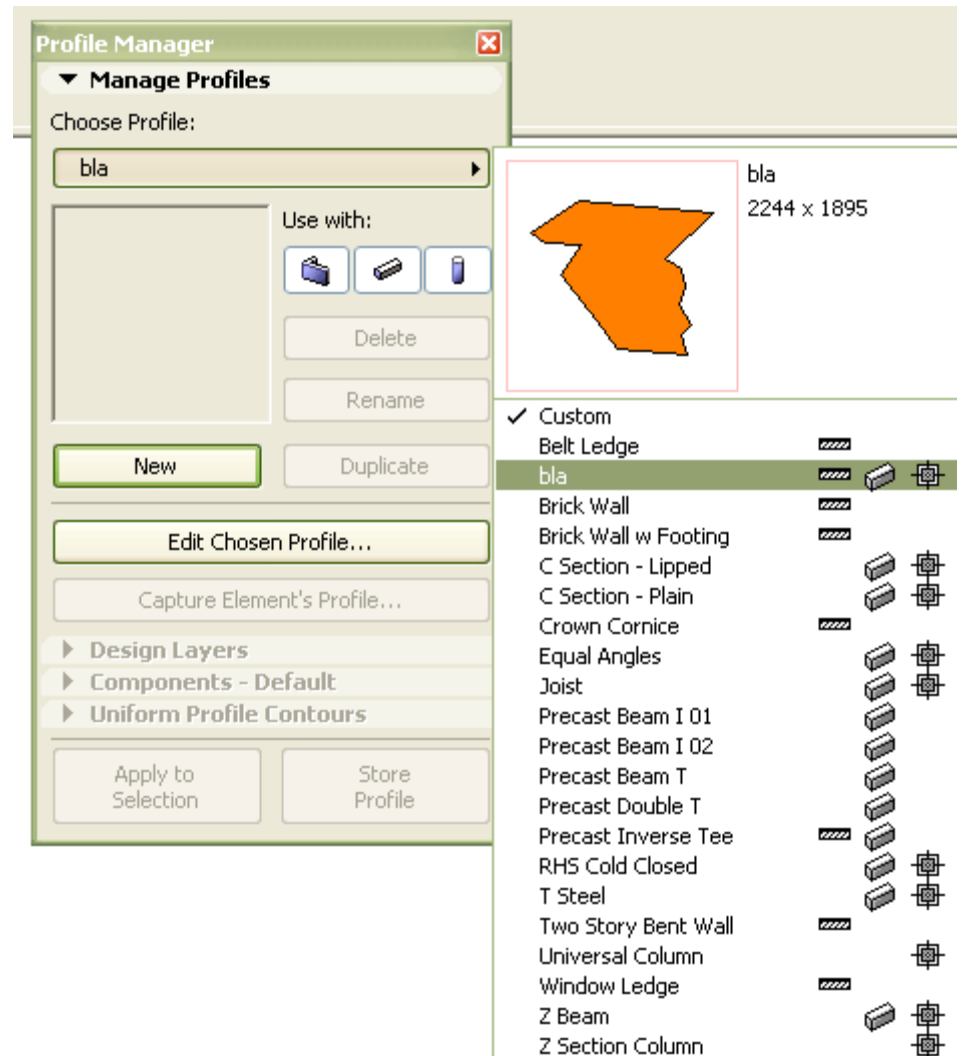
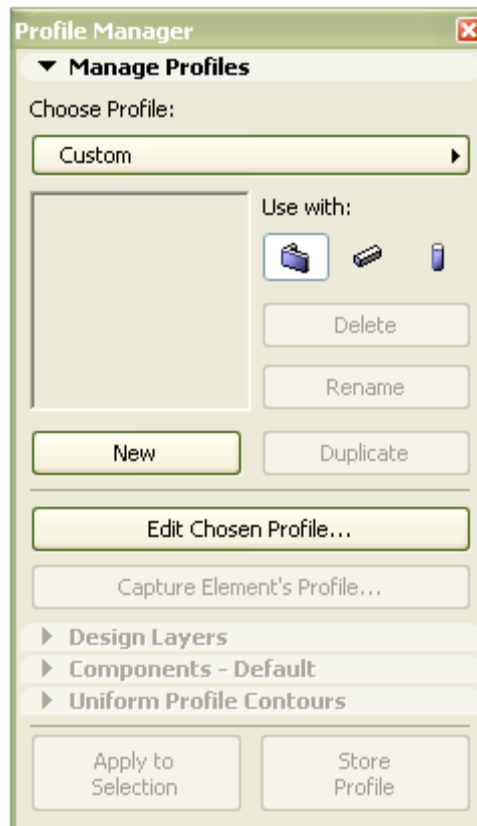

Профил менаџер

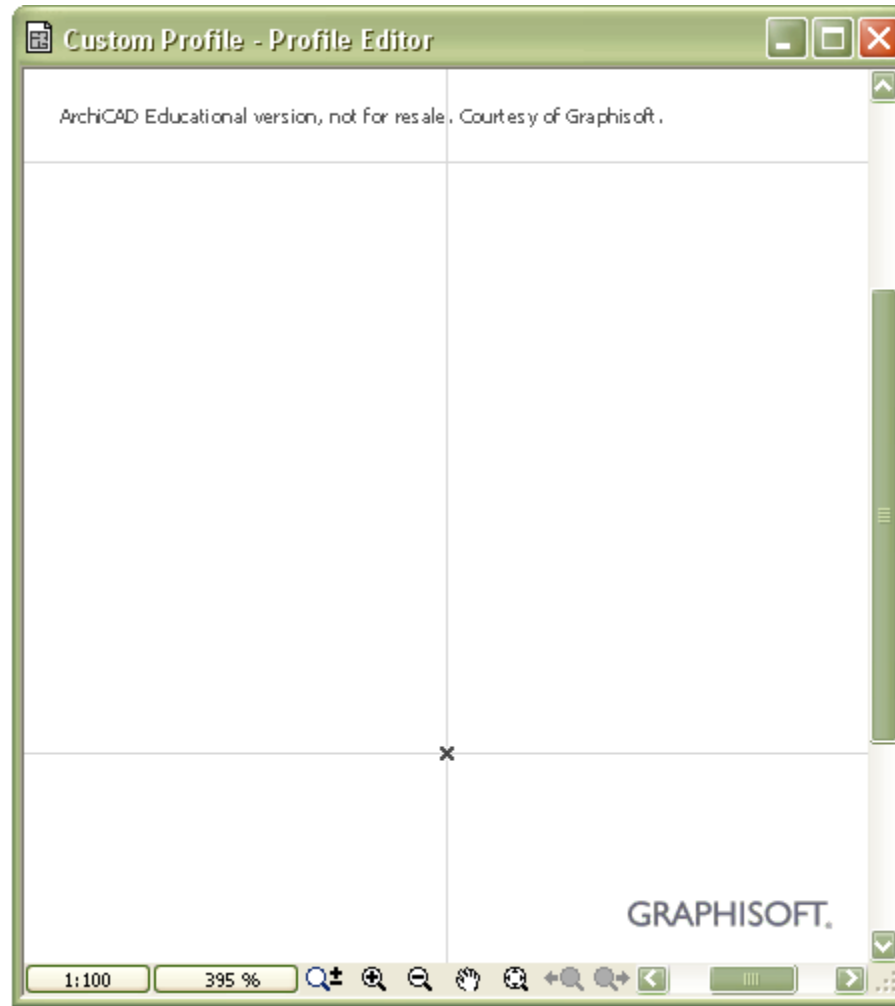

Стубови

Column Default Settings [?] [X] Default

Favorites...

Geometry and Positioning

2800
to Current Story ▾

0
to Project Zero ▾

0.00°

Home Story: Automatic ▾

1895

2244

Veneer

0

90.00°

Anchor Point of Core:

Floor Plan and Section

Model

Listing and Labeling

ID: CRE - 010

Label Column

Label Settings...

Relation to Zones: Zone Boundary ▾

Link Properties:
 By Criteria

Matching Properties:

Individually Choose...

Structural - Bearing ▾

Cancel OK

Стубови

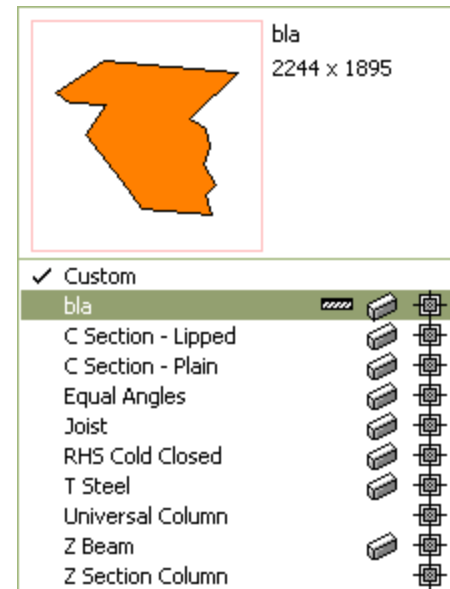
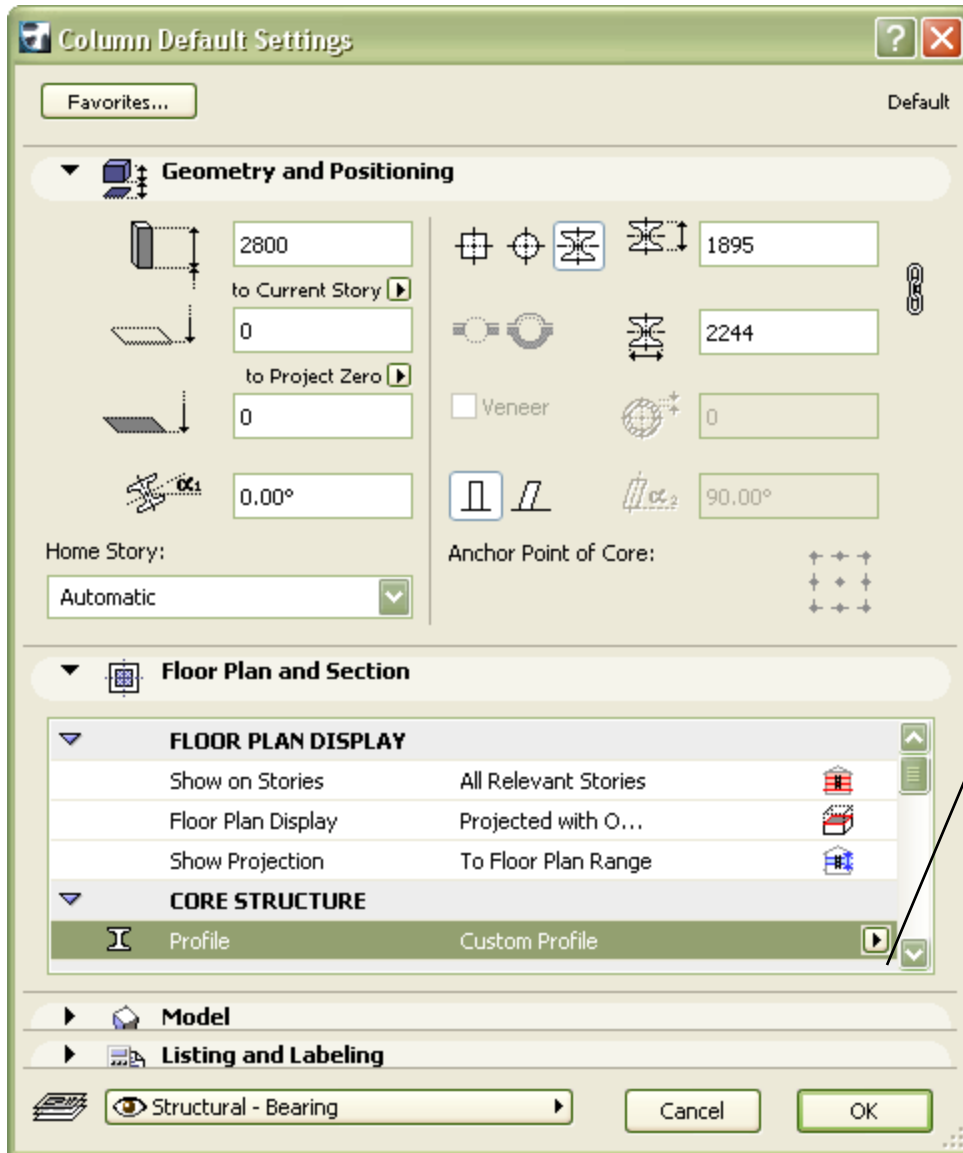

Постављање стубова

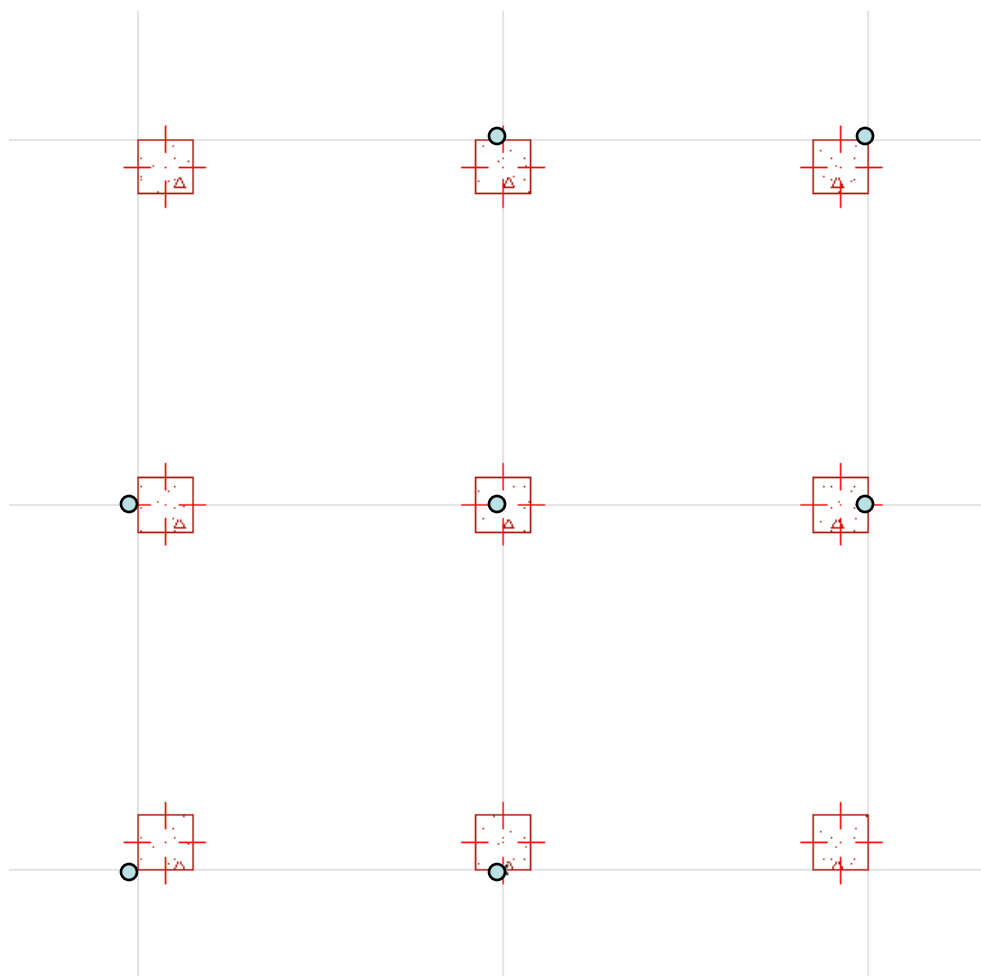
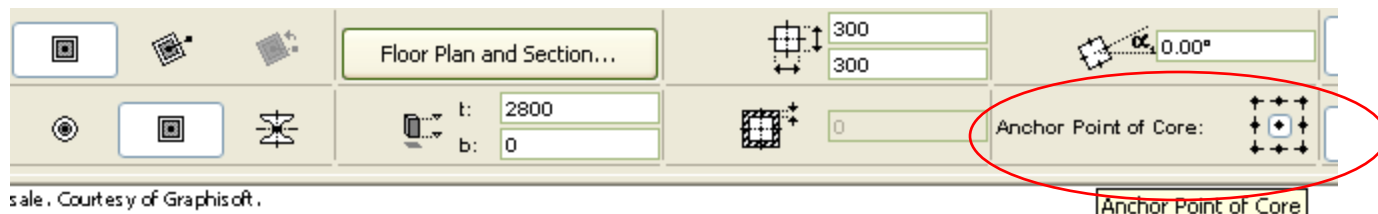

Тачка
постављања –
референтна
тачка

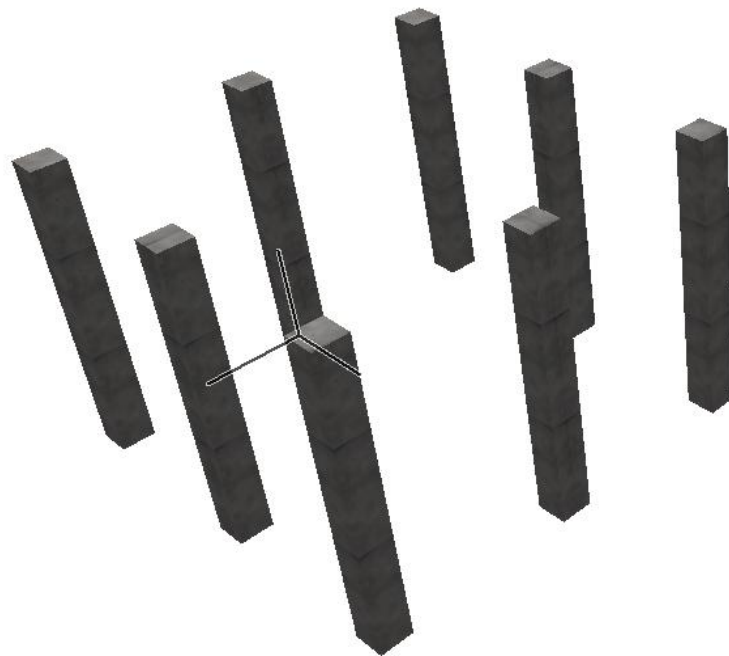

Греде

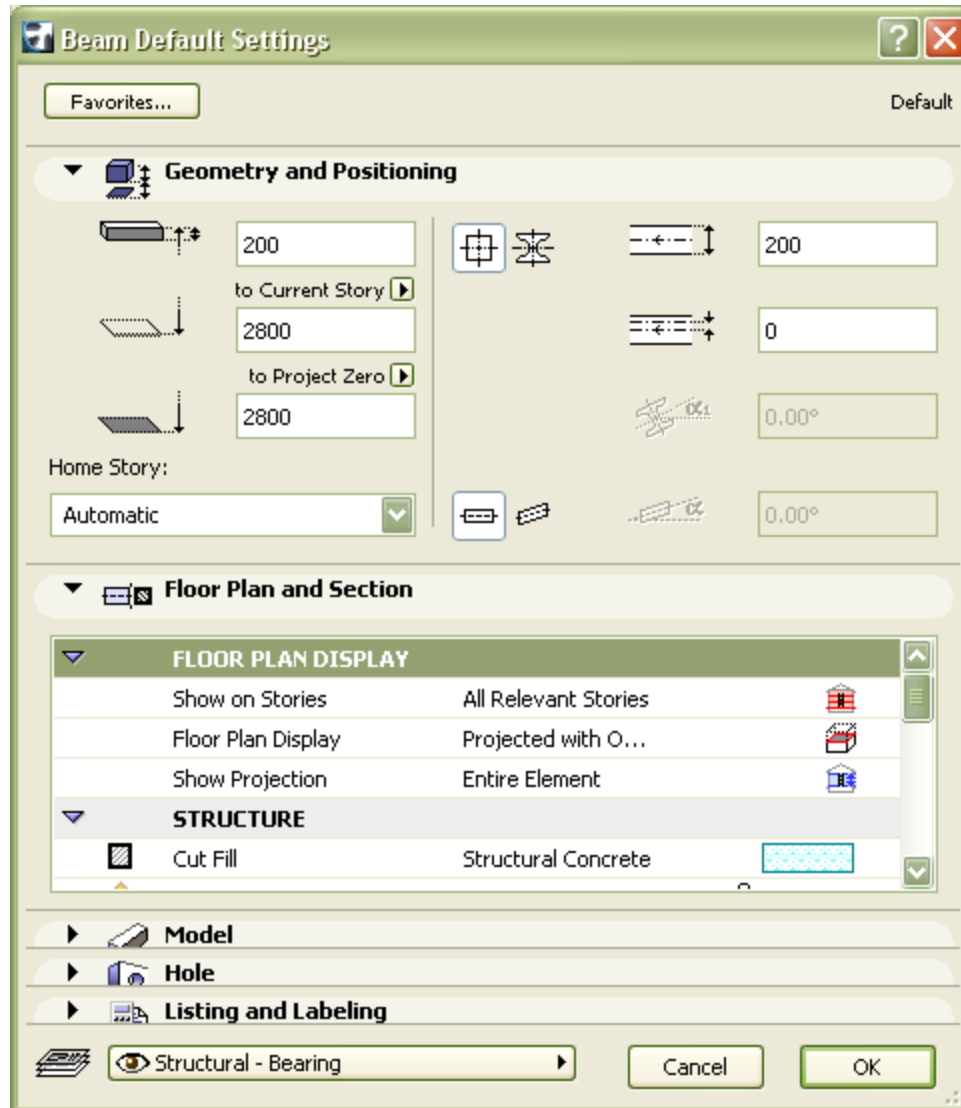

Греде

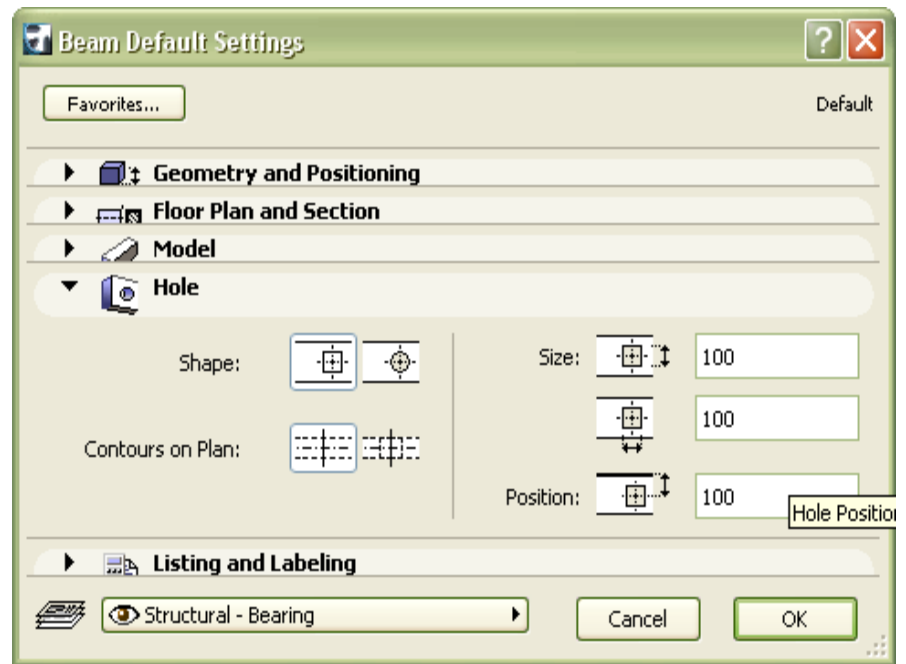

Поставляње греде

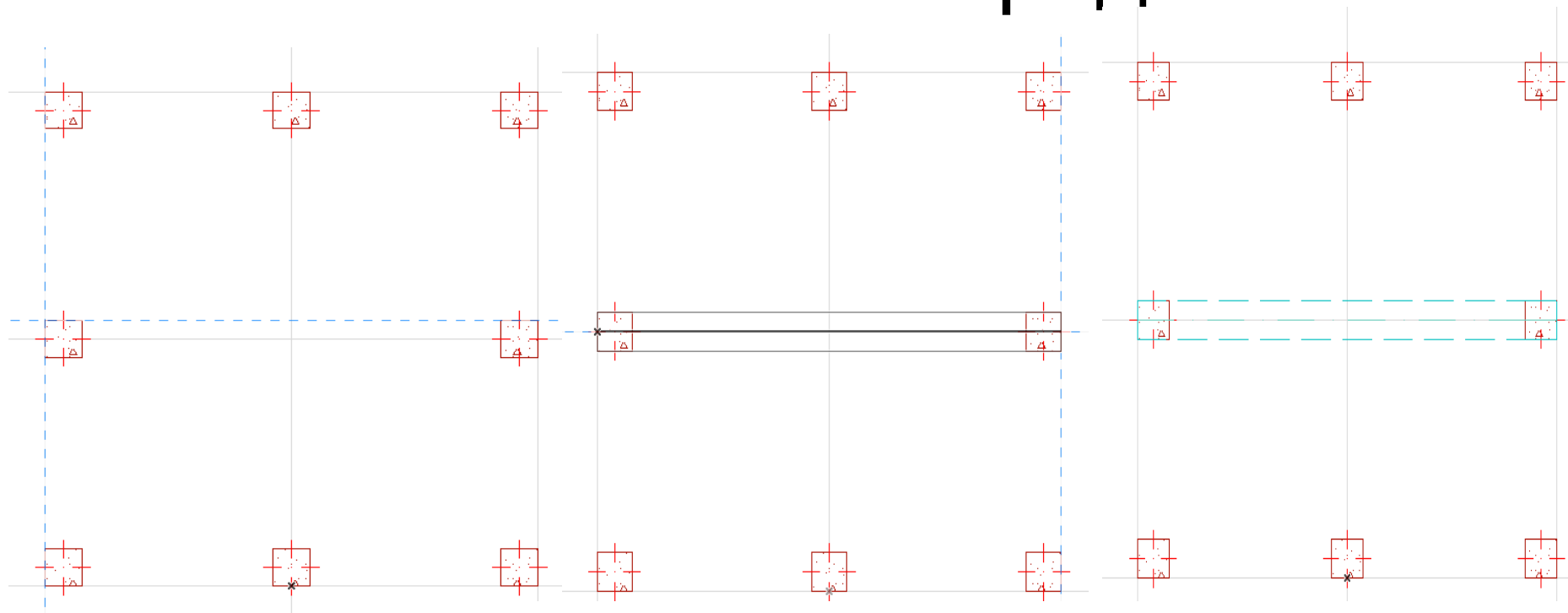

Постављање греде под углом

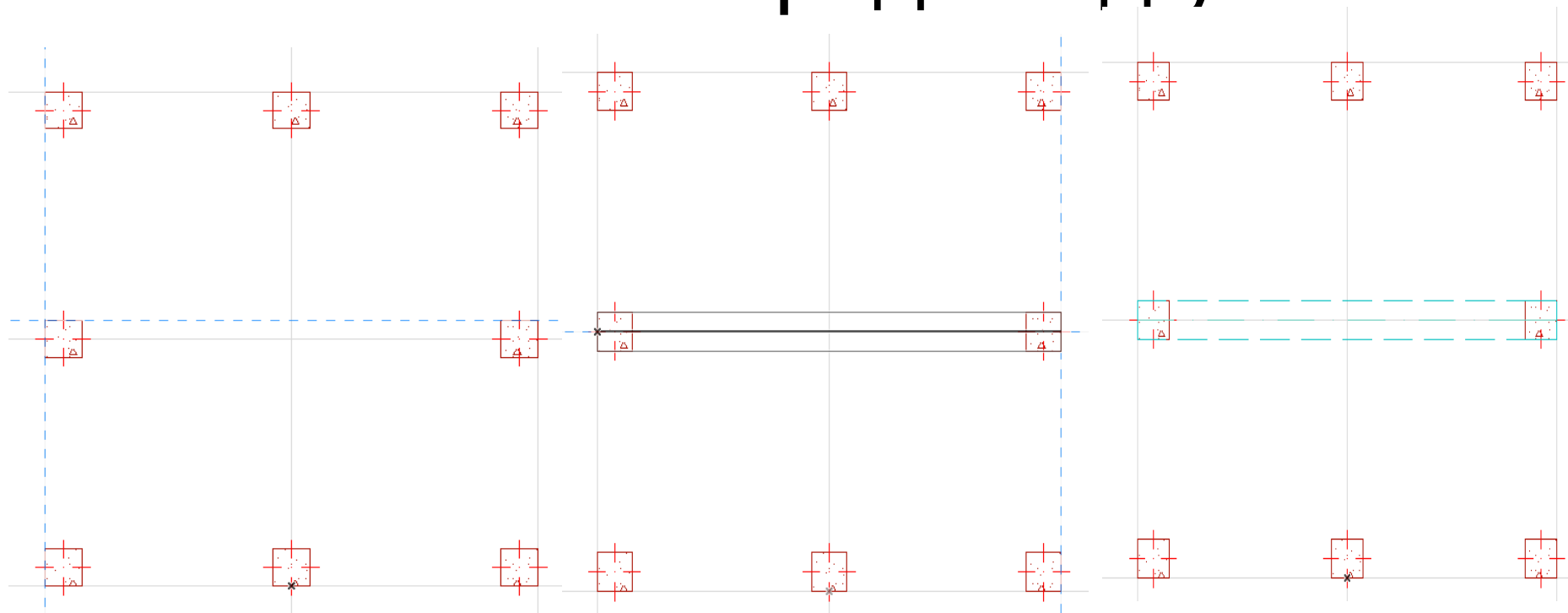

Trace and reference opcija

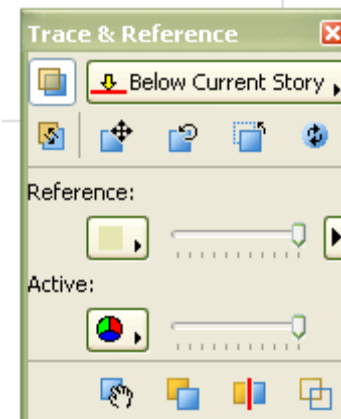
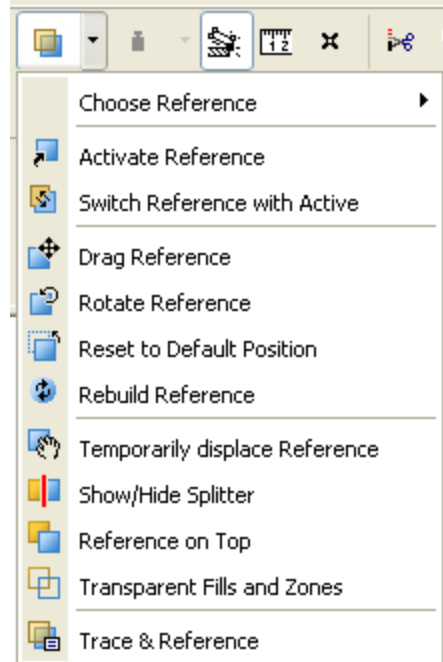

Trace and reference opcija

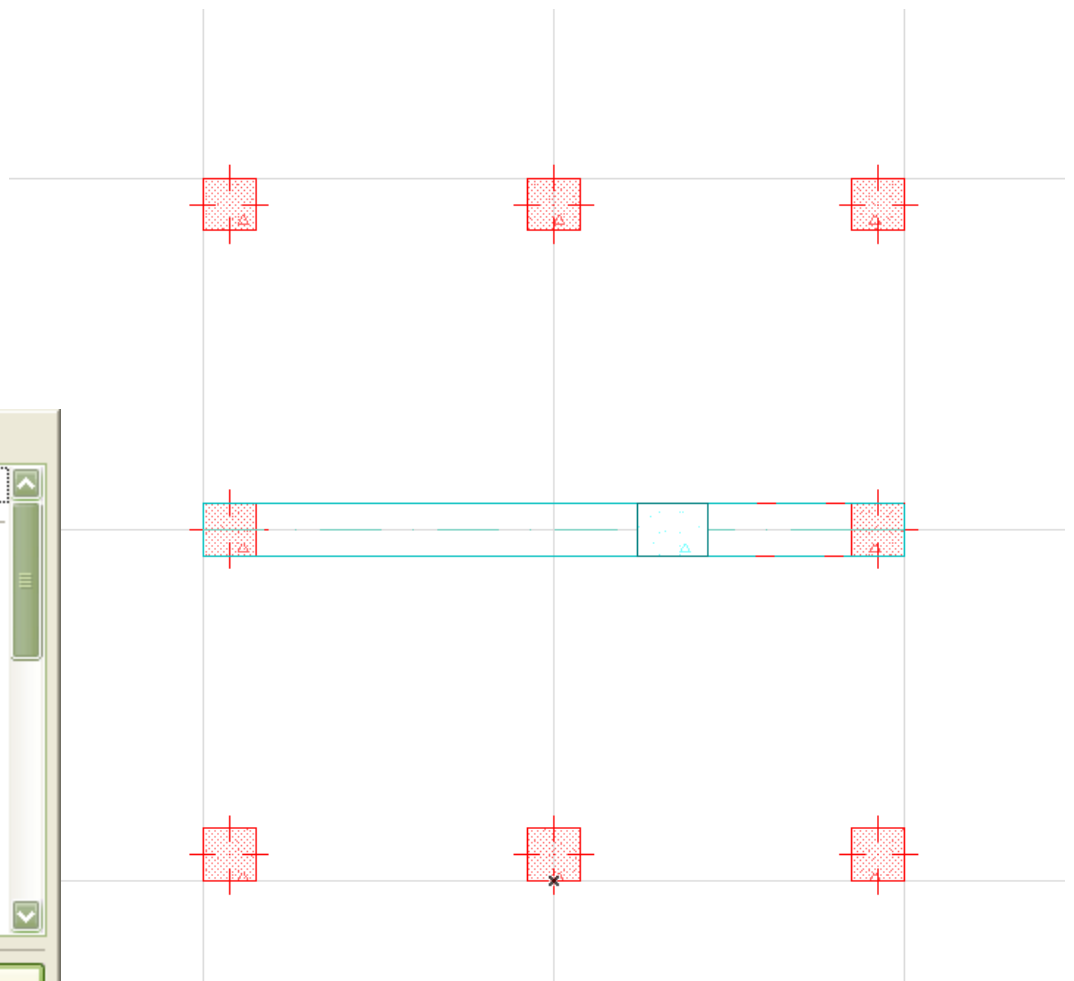
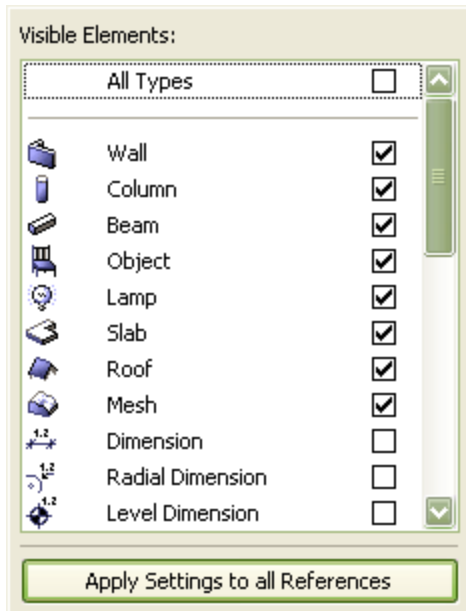
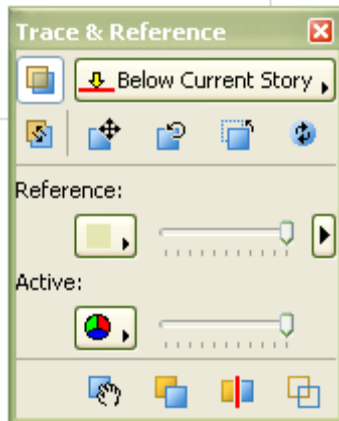

Подешавање окружења

Селекција и информације о елементима

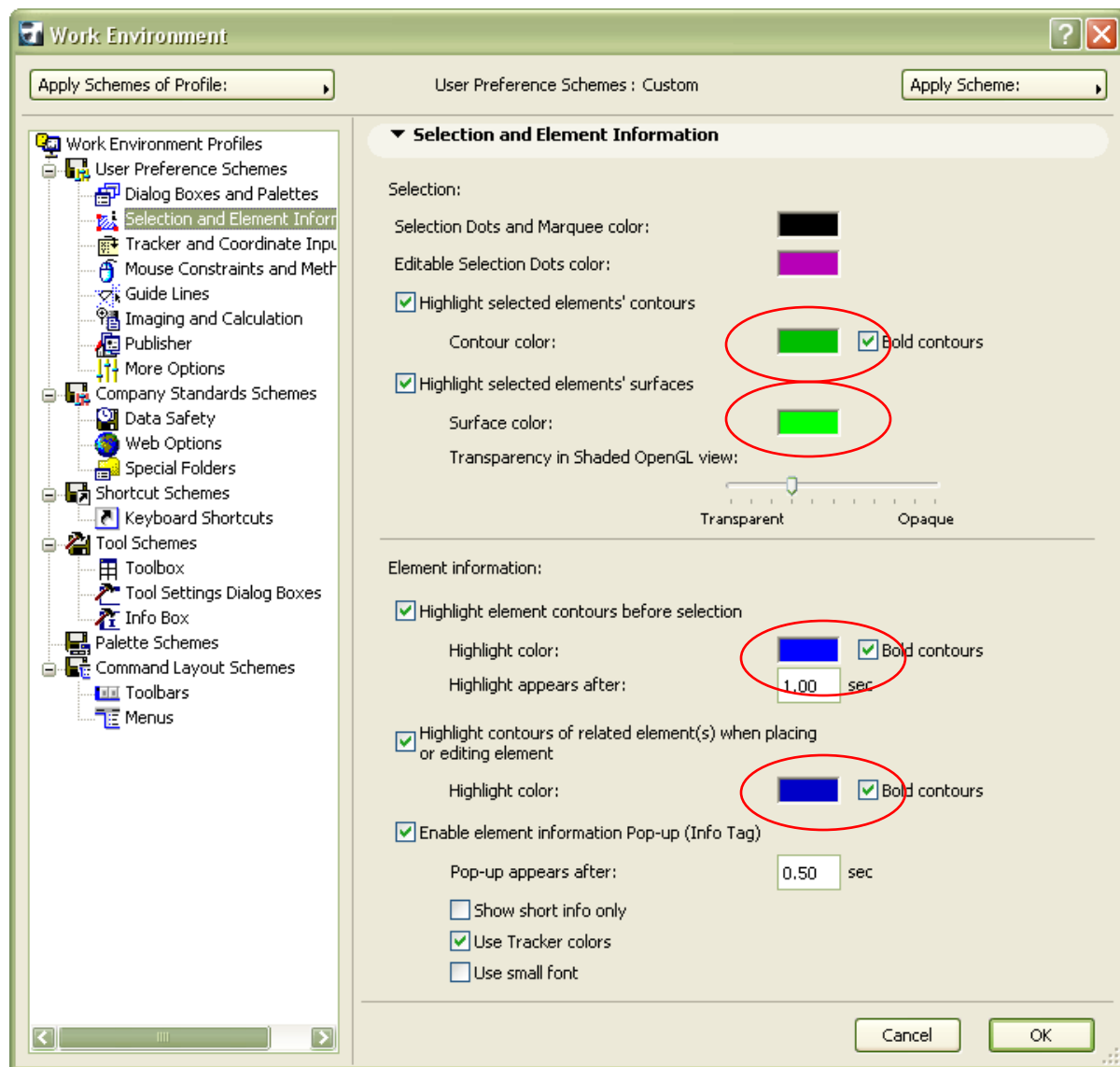

Подешавање окружења

Аутоматско
чување
података

Временско и
по броју
корака

Undo
ограничења

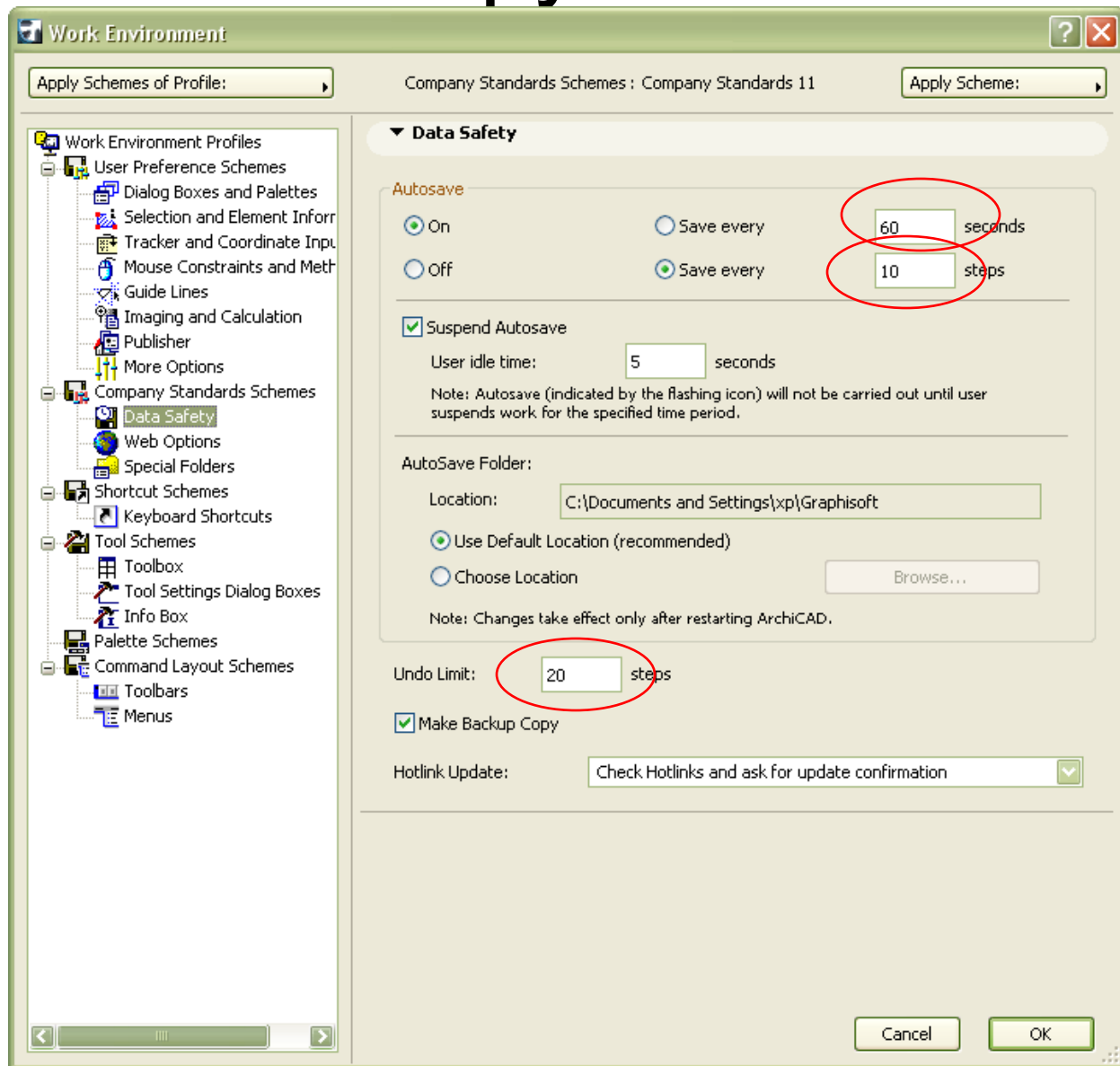

Подешавање окружења

Убацивање
скраћеница за
команде

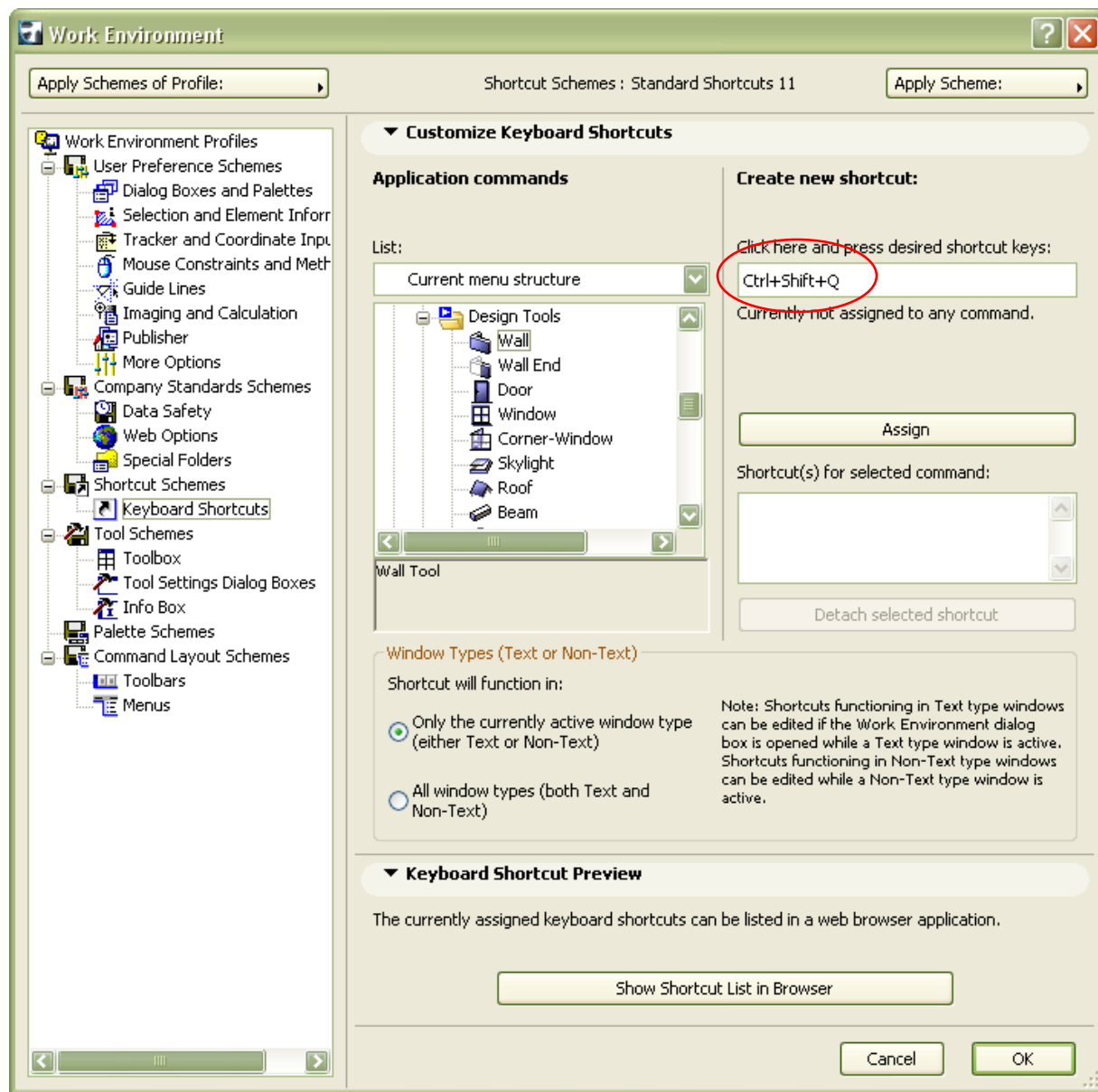

Marquee

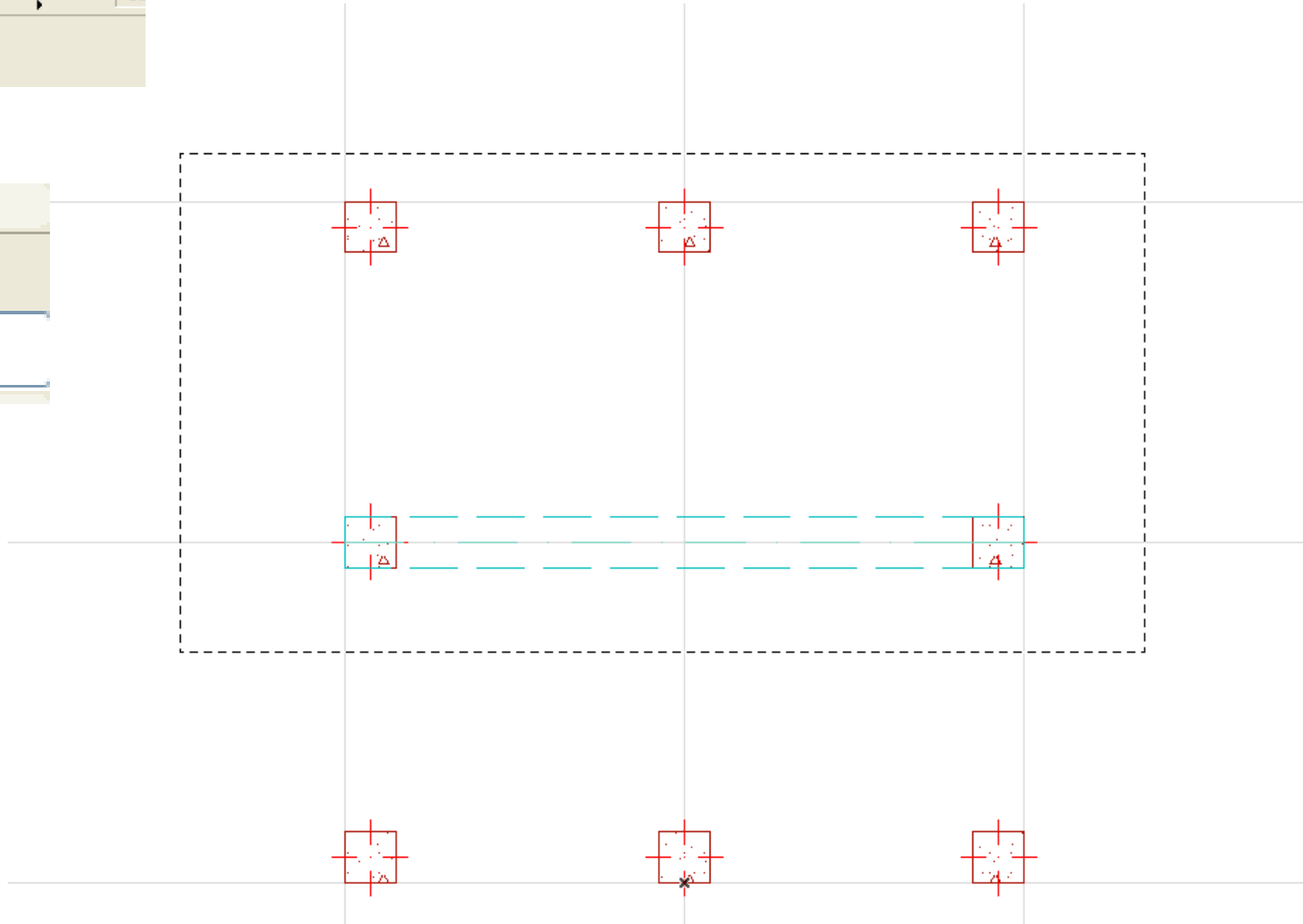

Marquee

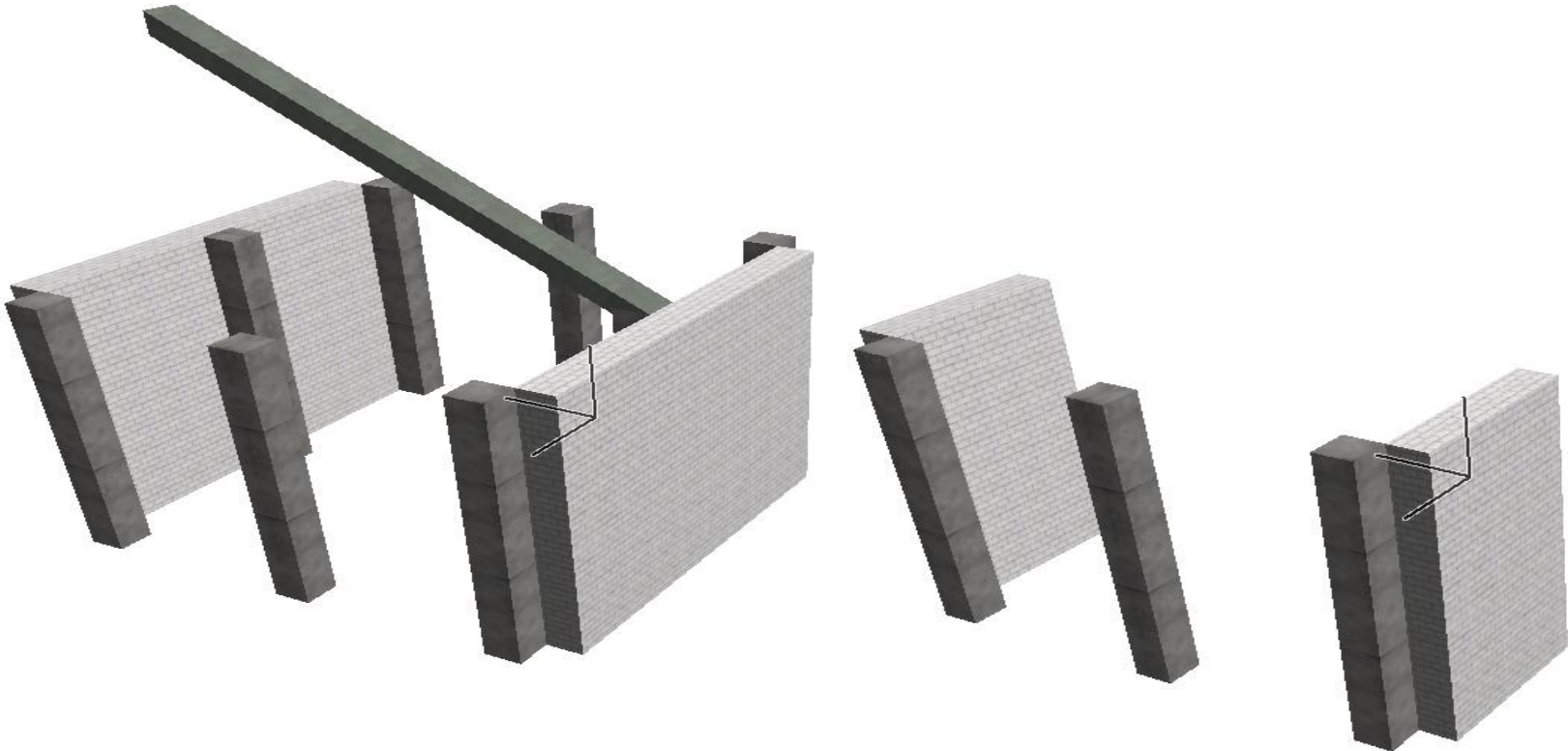

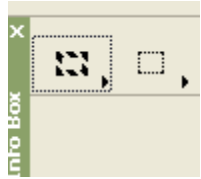

Marquee

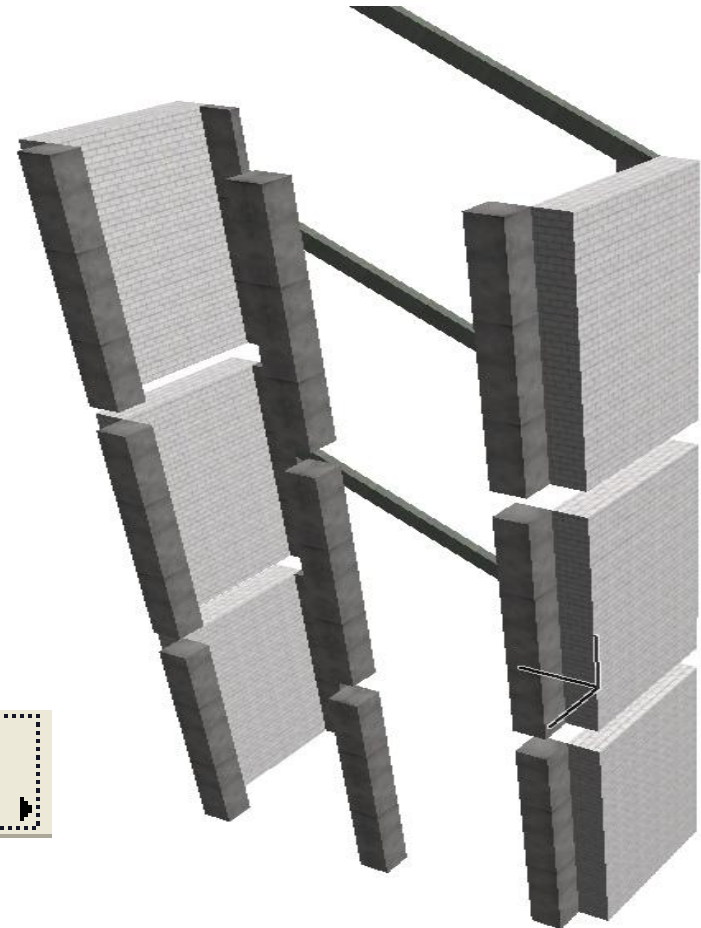
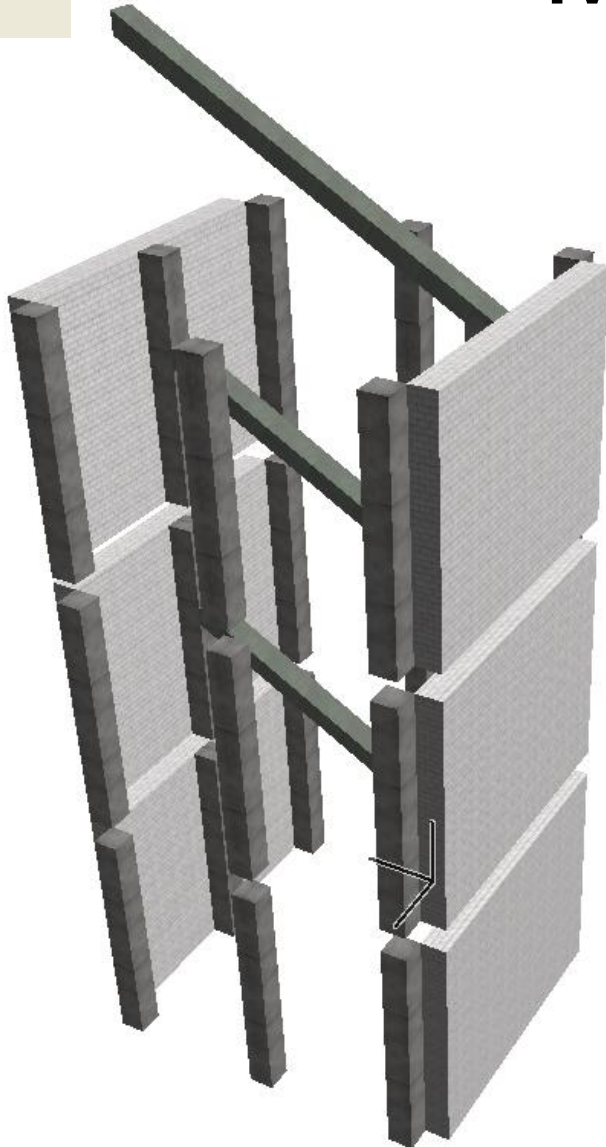

Hot spot

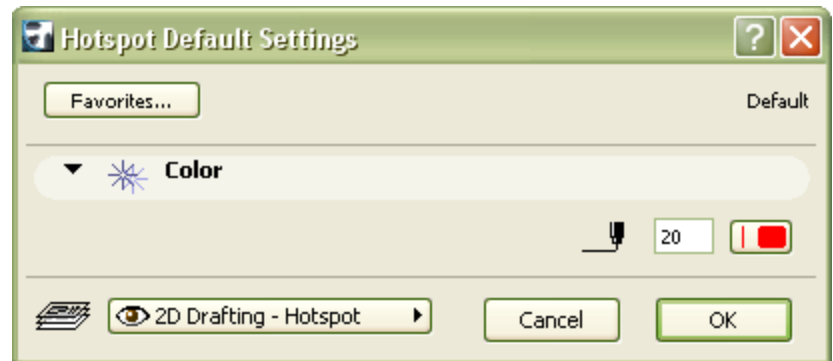
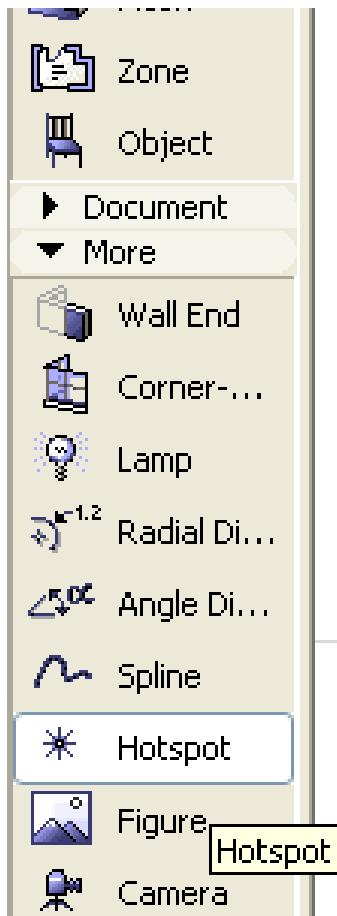

Крајеви зидова

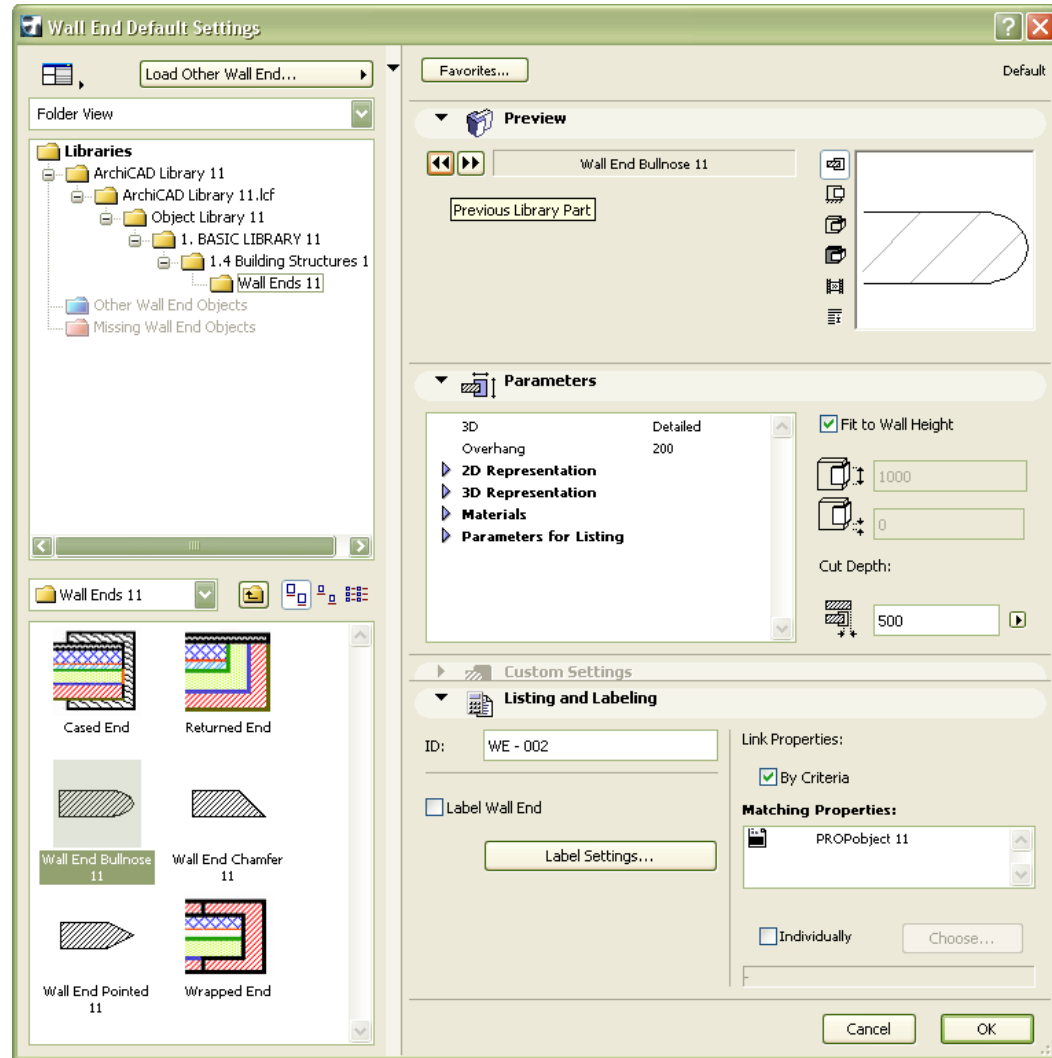
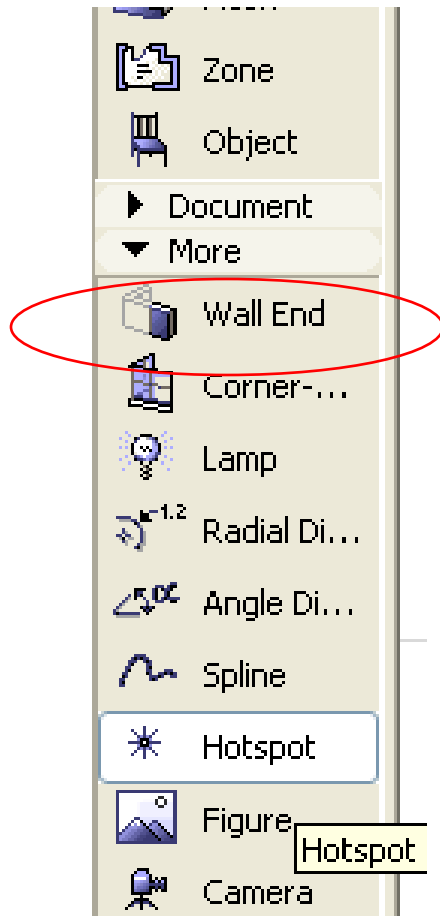

Крајеви зидова

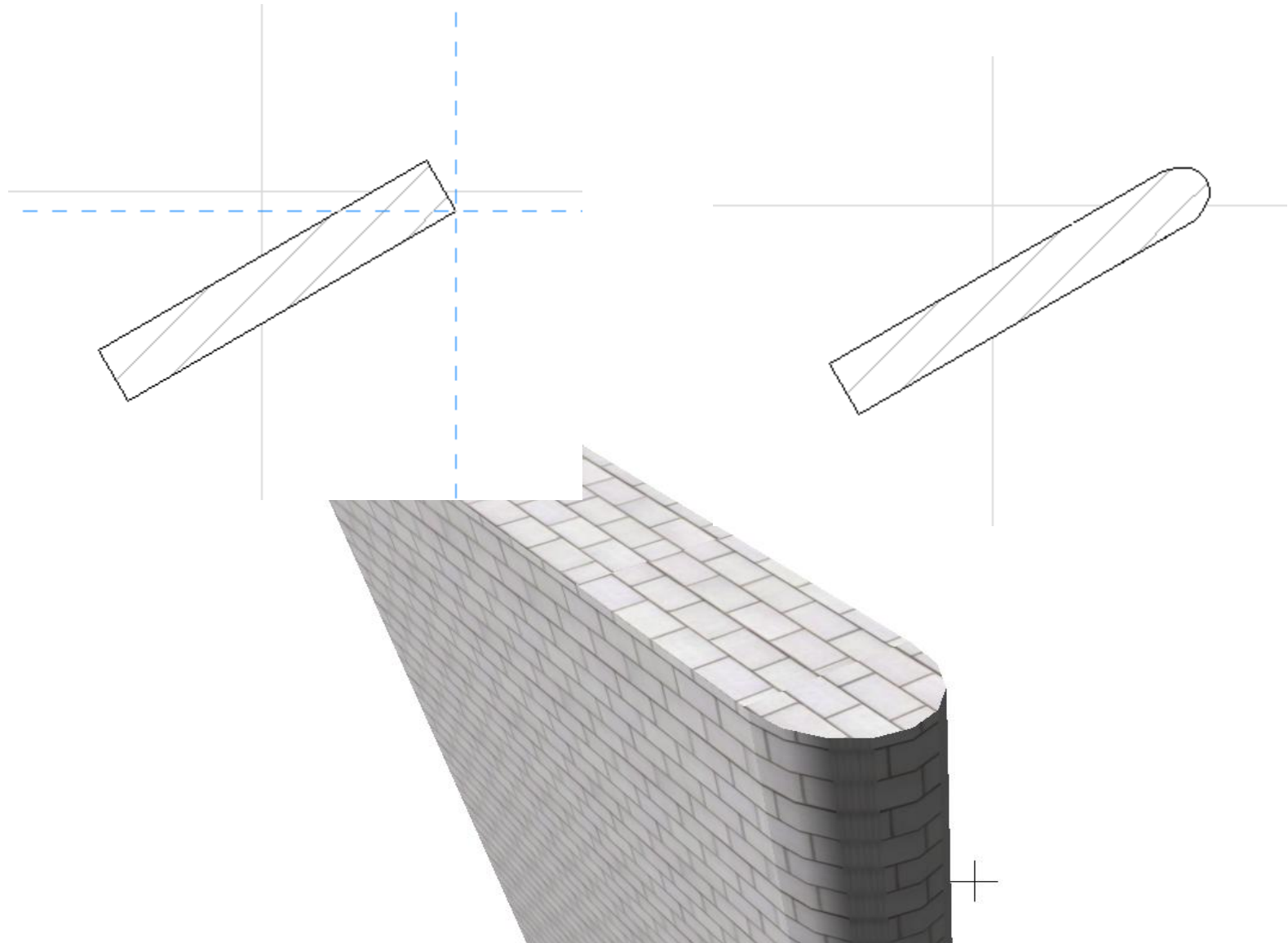

Мерења – брза – measure (M)

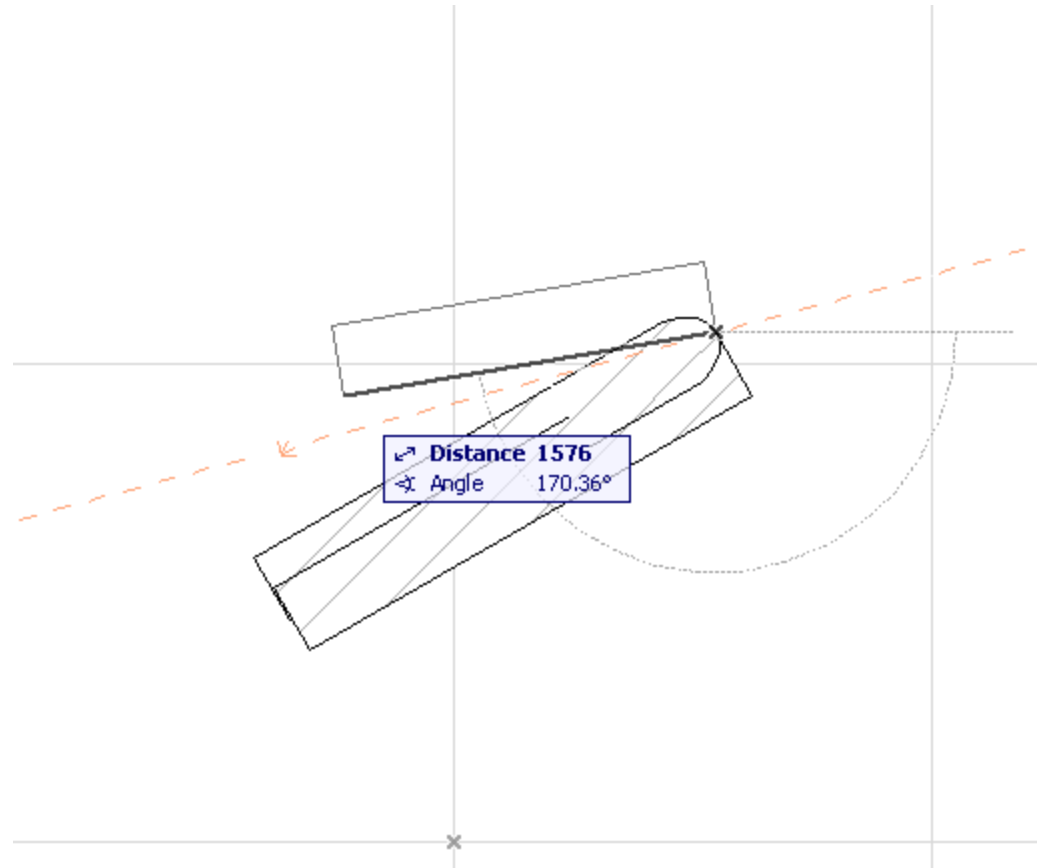
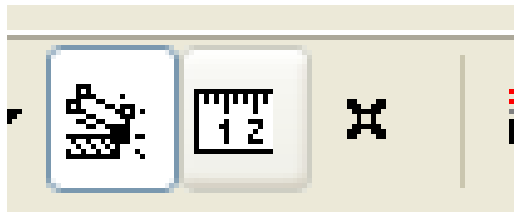

Capture – копирање особина

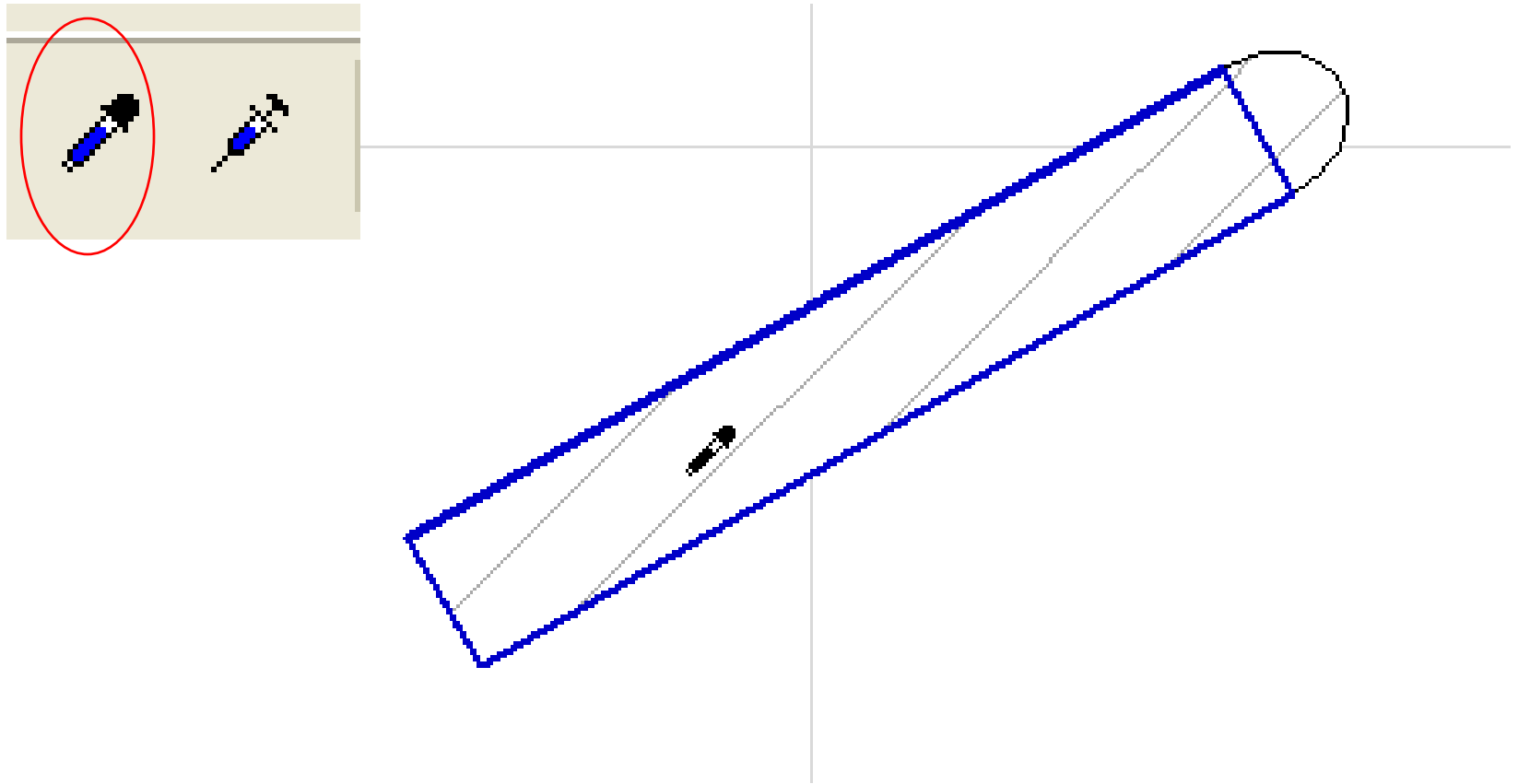

Inject – давање копираних особина

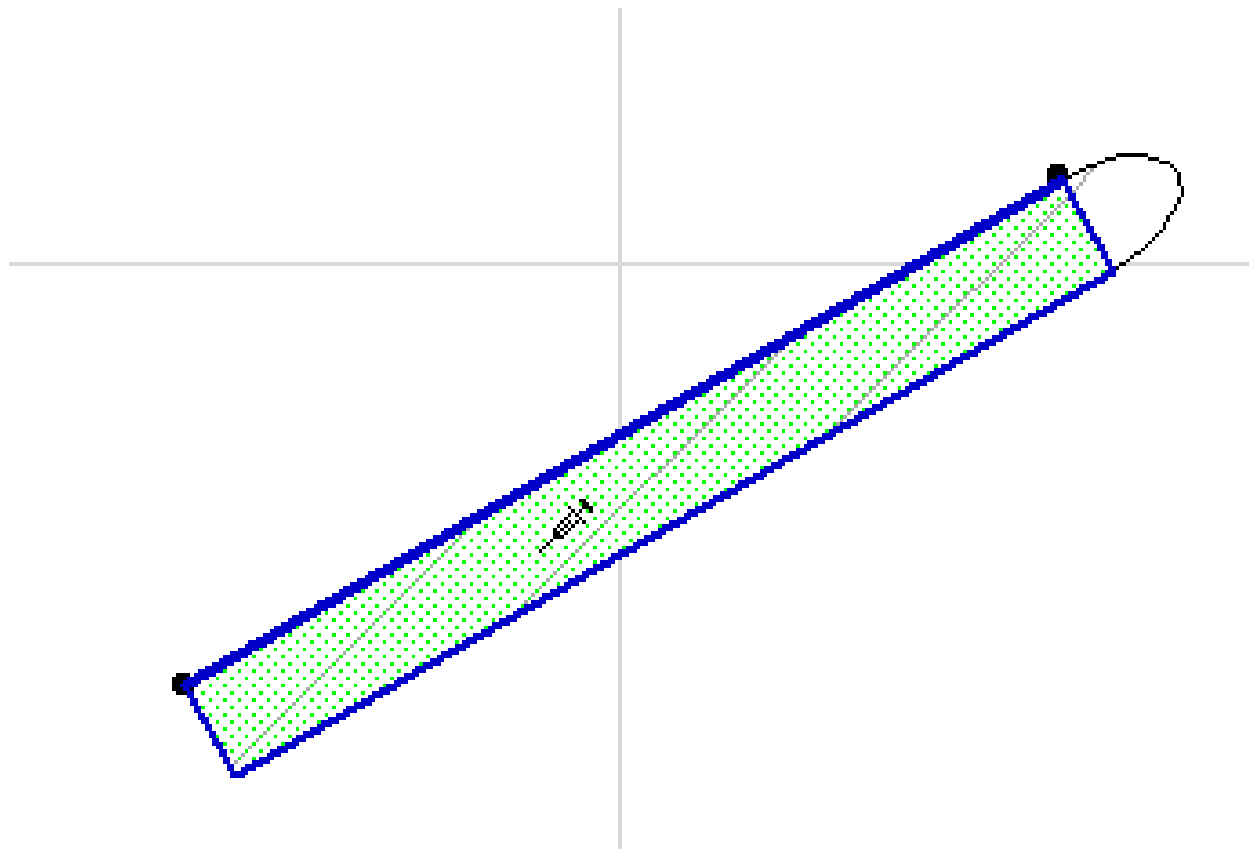
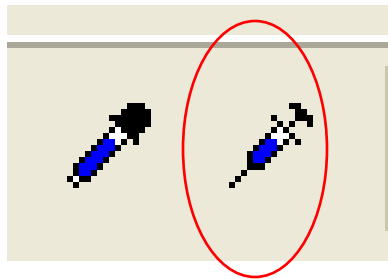

Find and Select

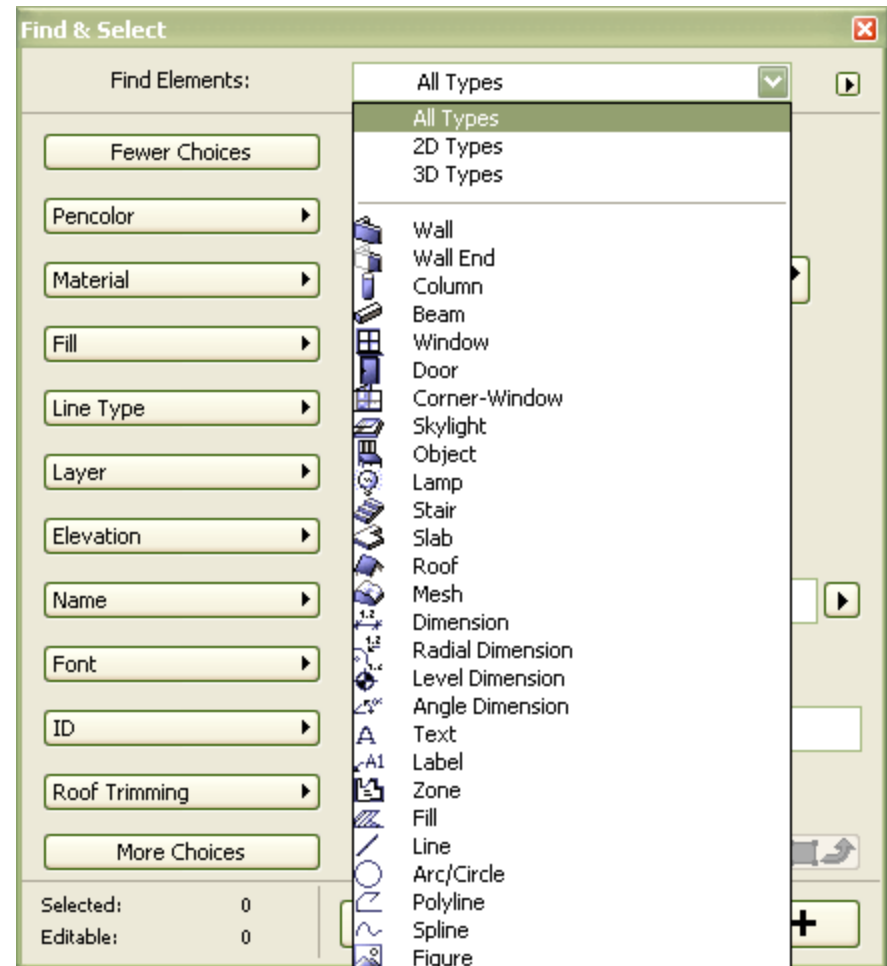
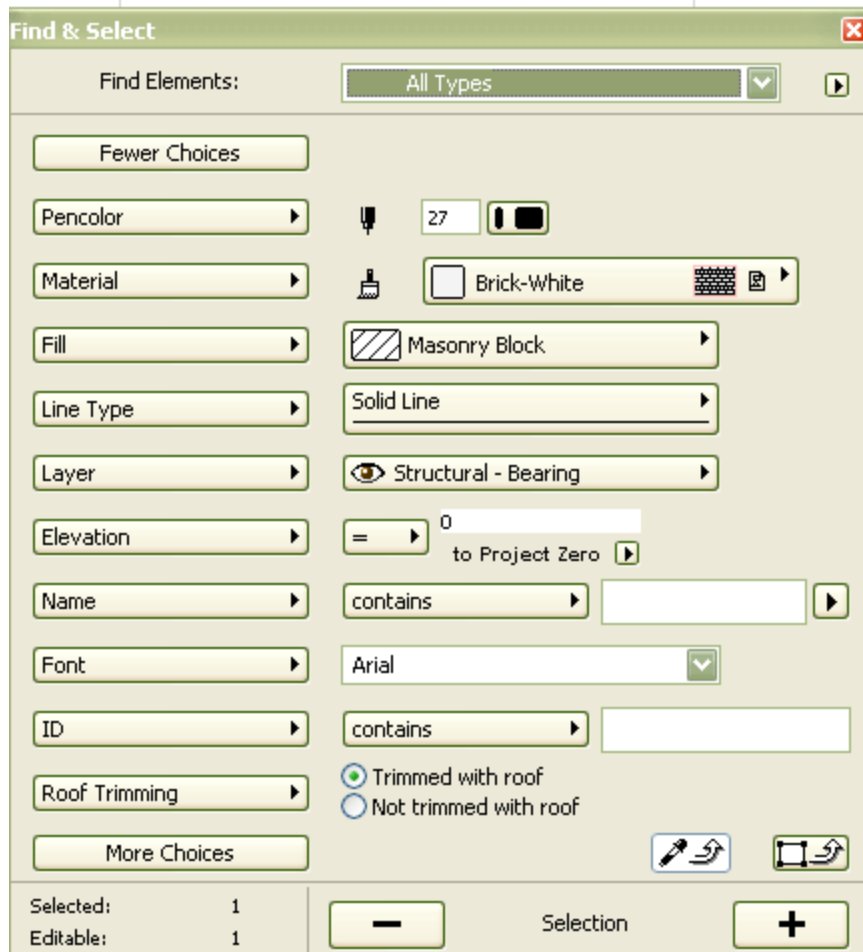

Висина пресека хоризонтала

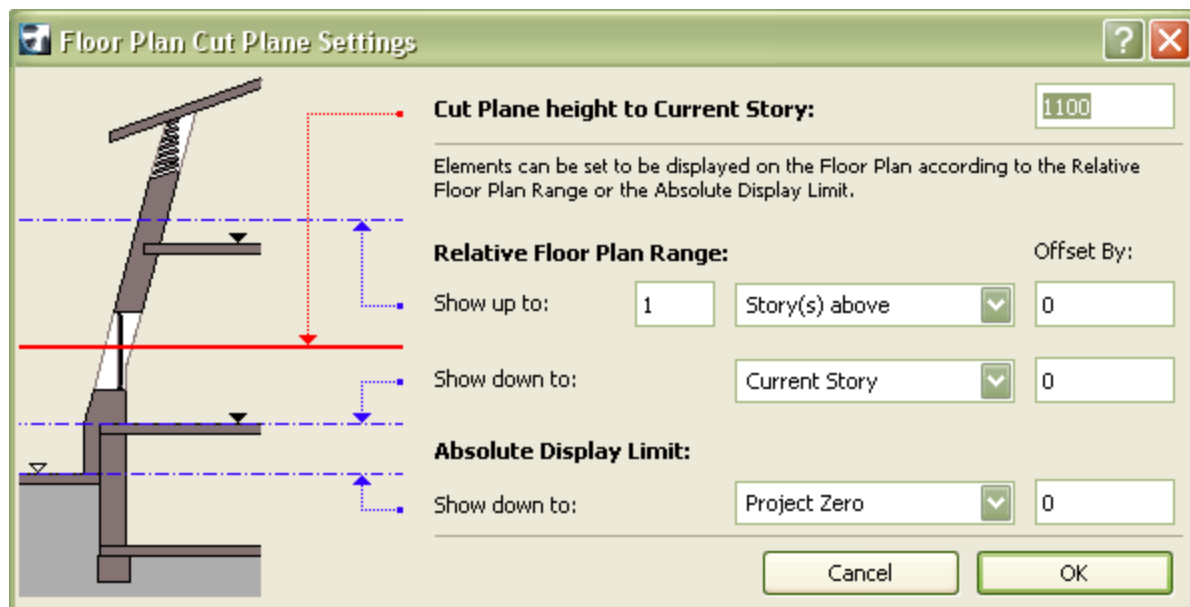
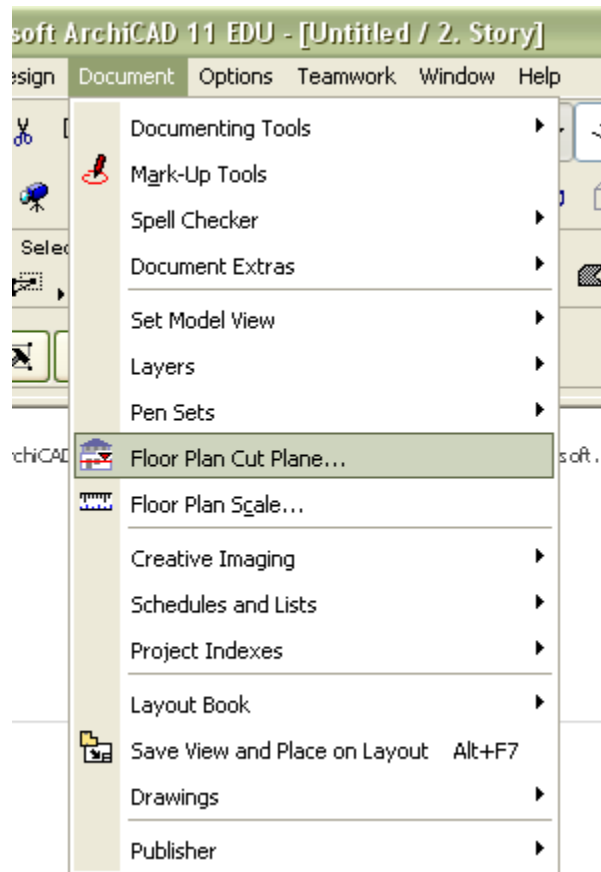

Аутоматско котирање

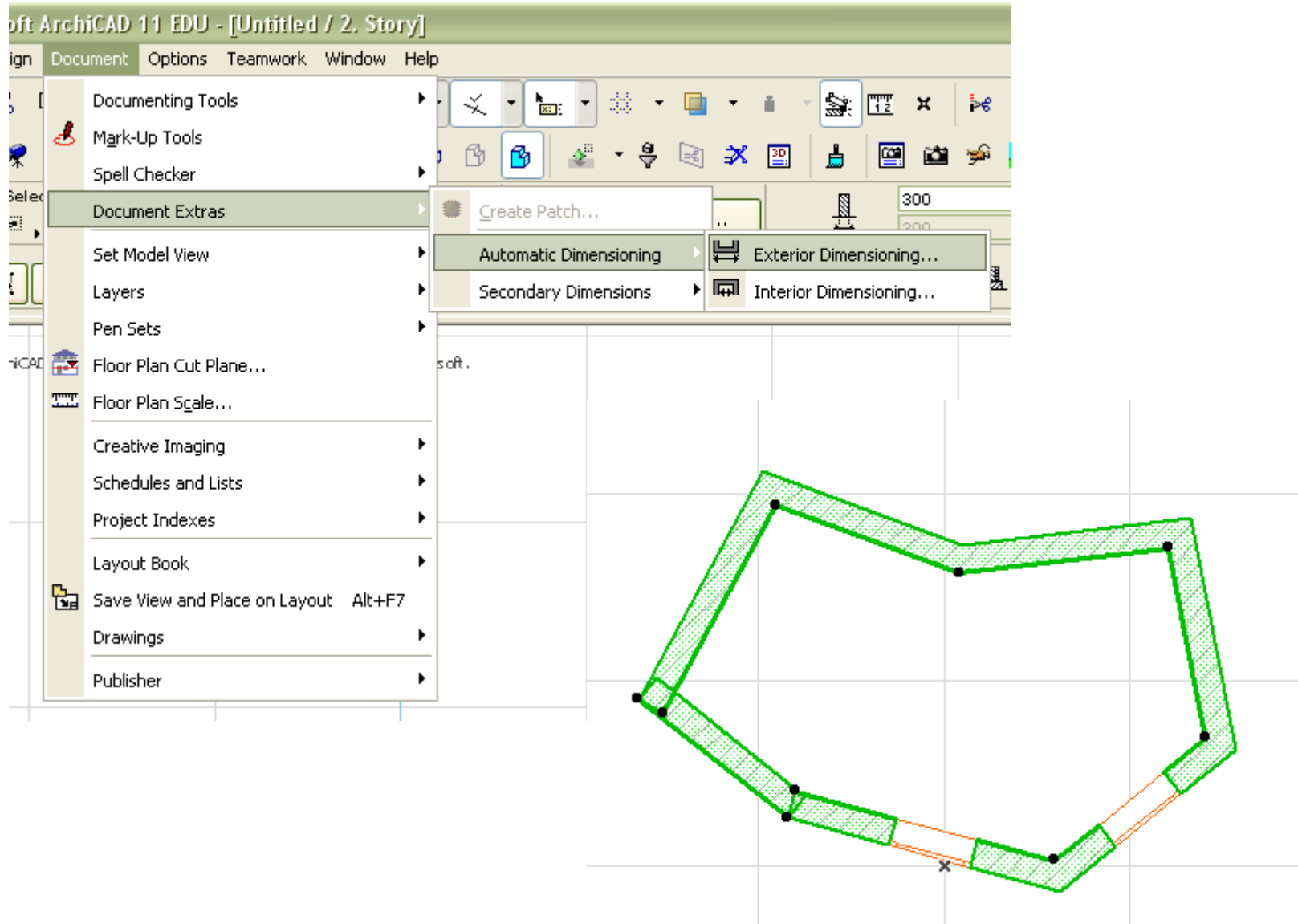

Аутоматско котирање

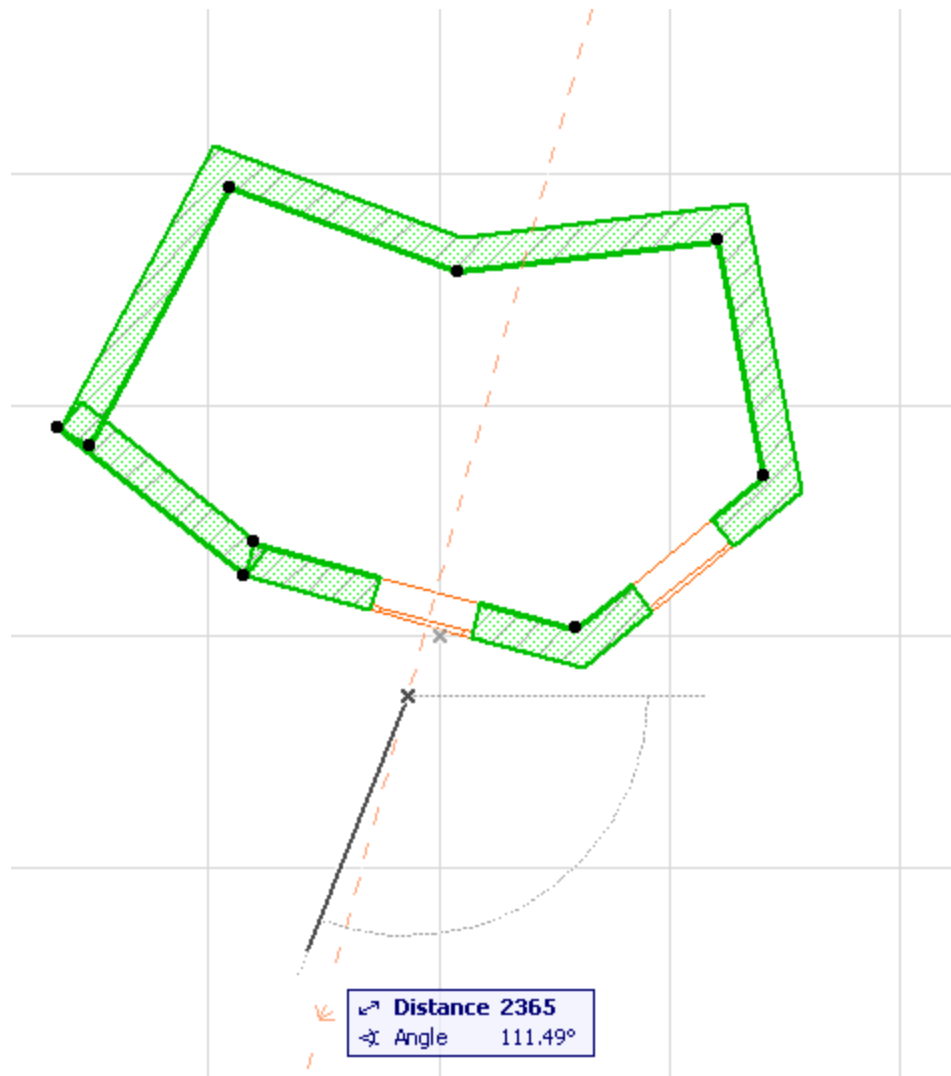
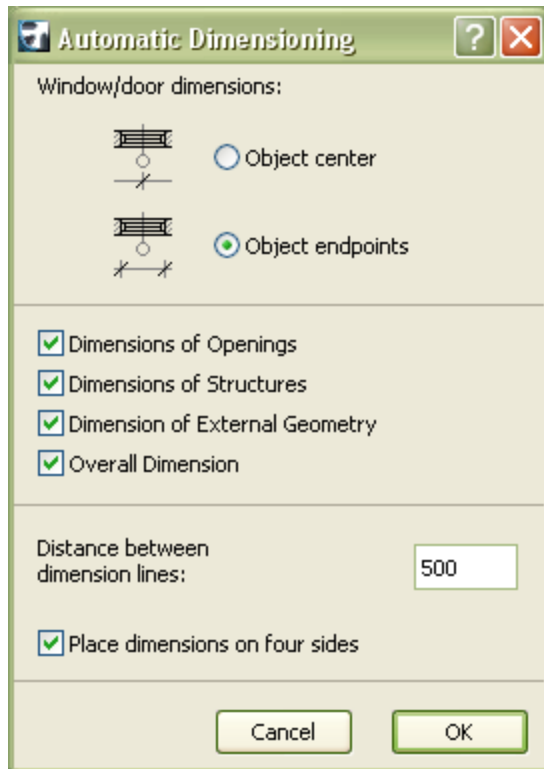

Аутоматско котирање

