

Софтвери у грађевинарству.

Предавање III

Пет палета - помоћна трака

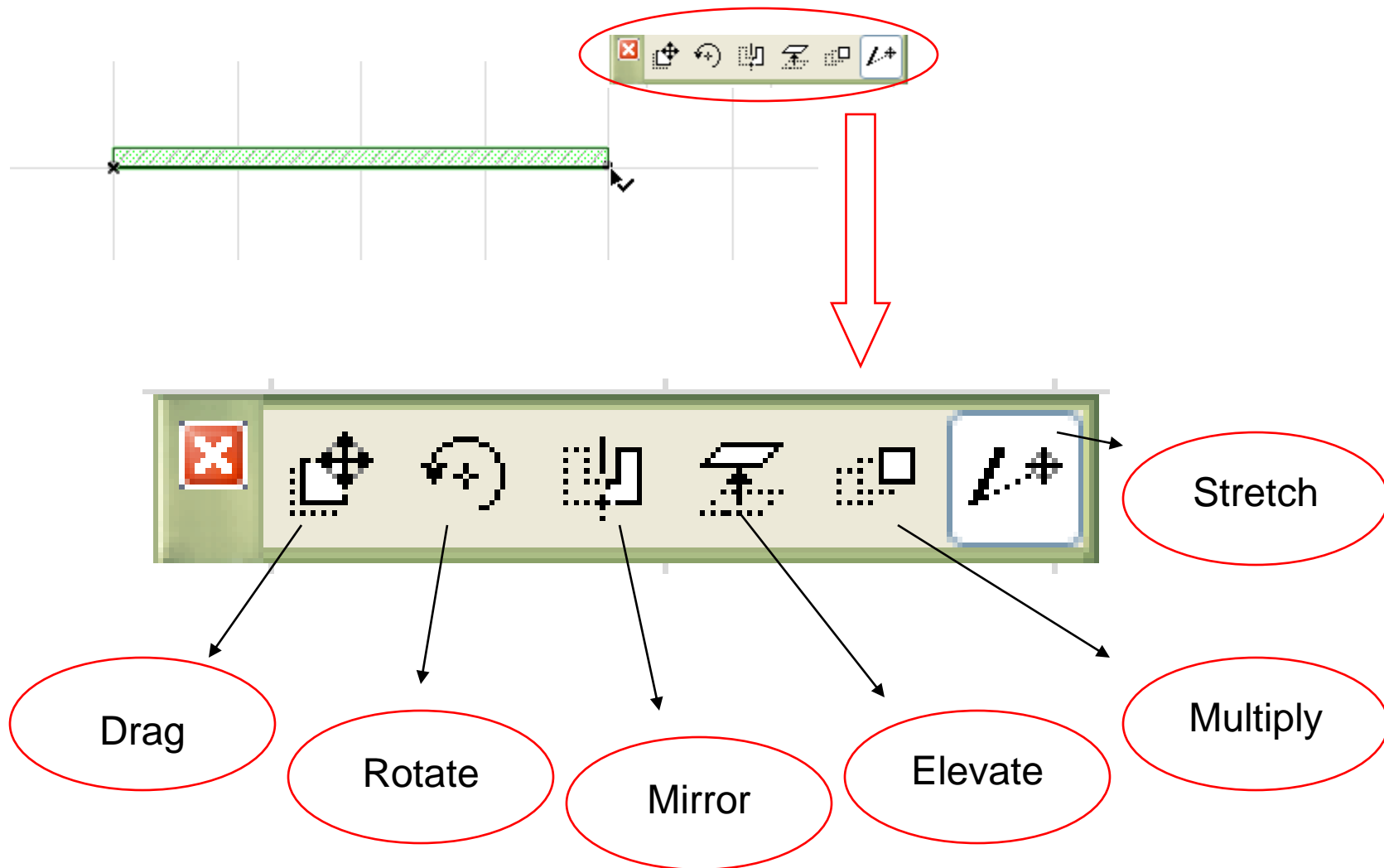

Пет палета - помоћна трака

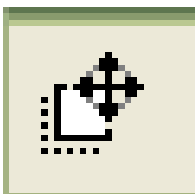

Drag

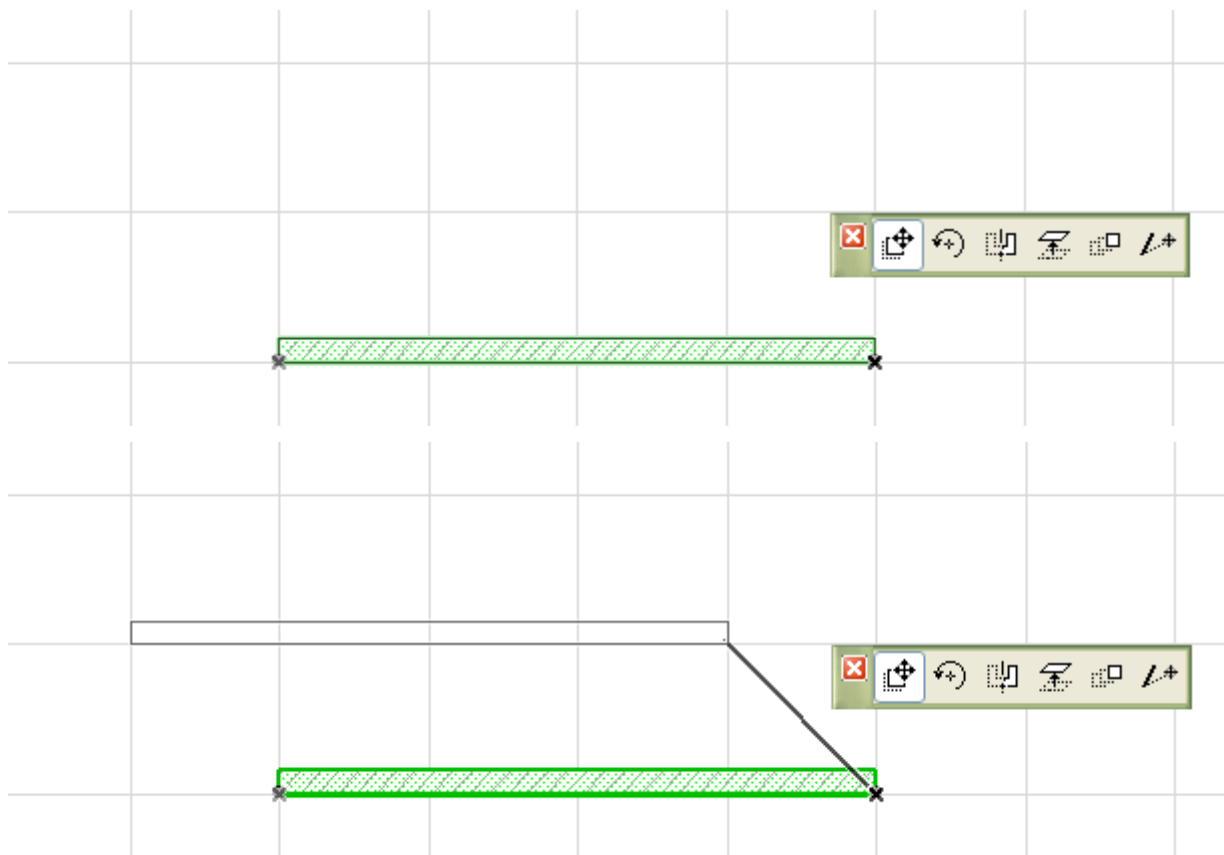

Пет палета - помоћна трака

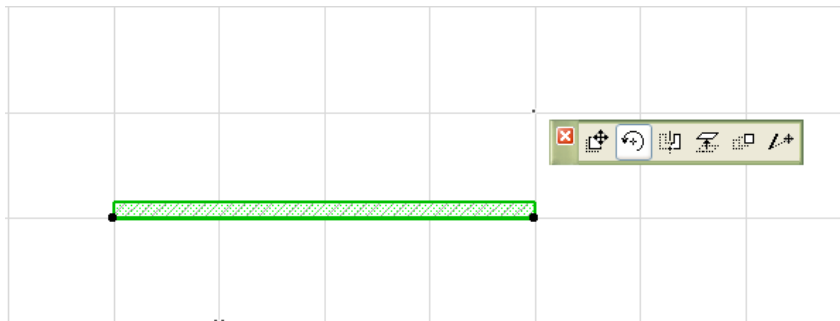
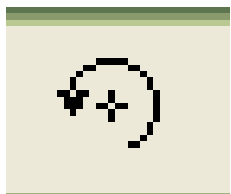

Rotate

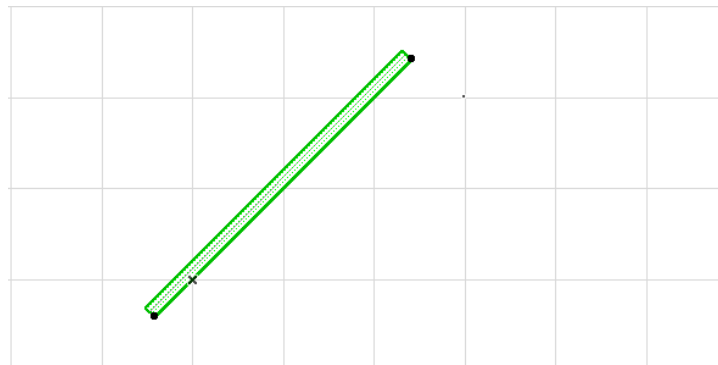
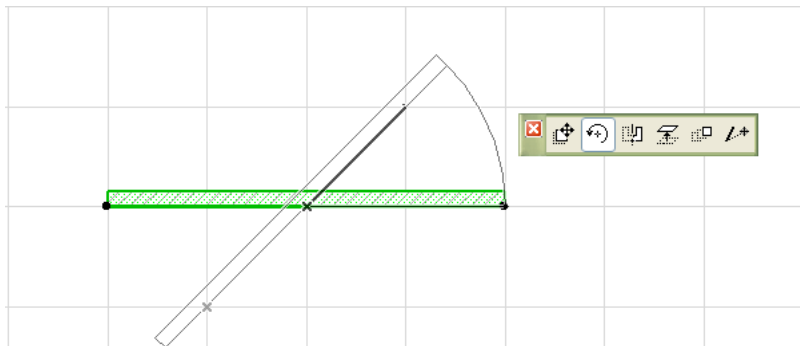
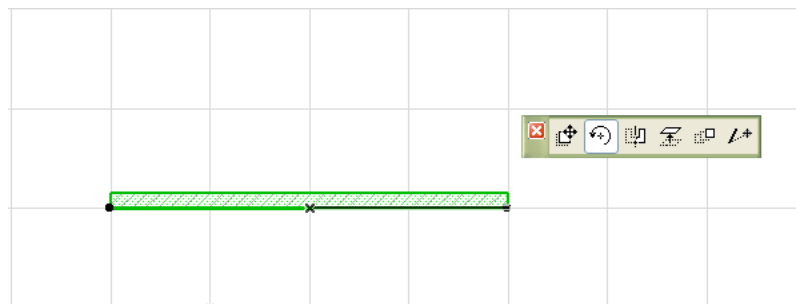
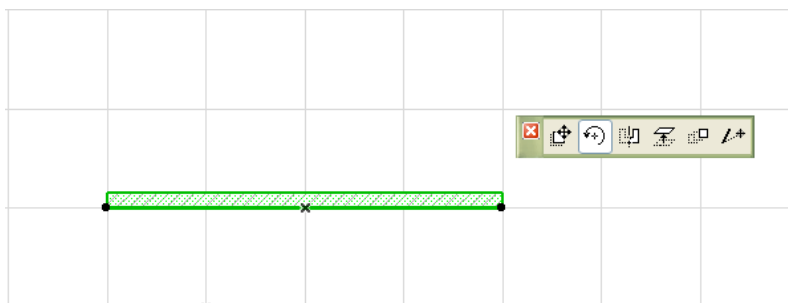

Пет палета - помоћна трака

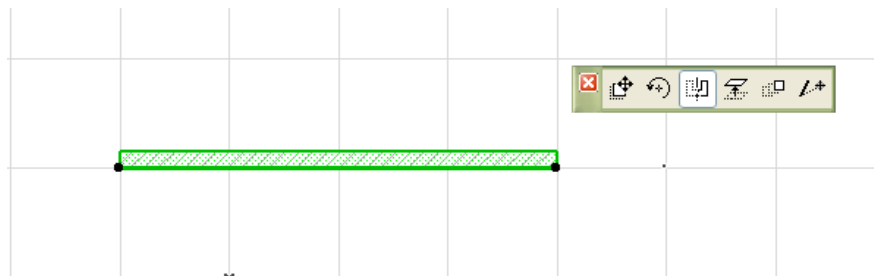
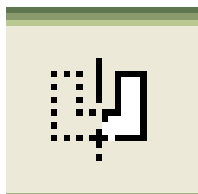

Mirror

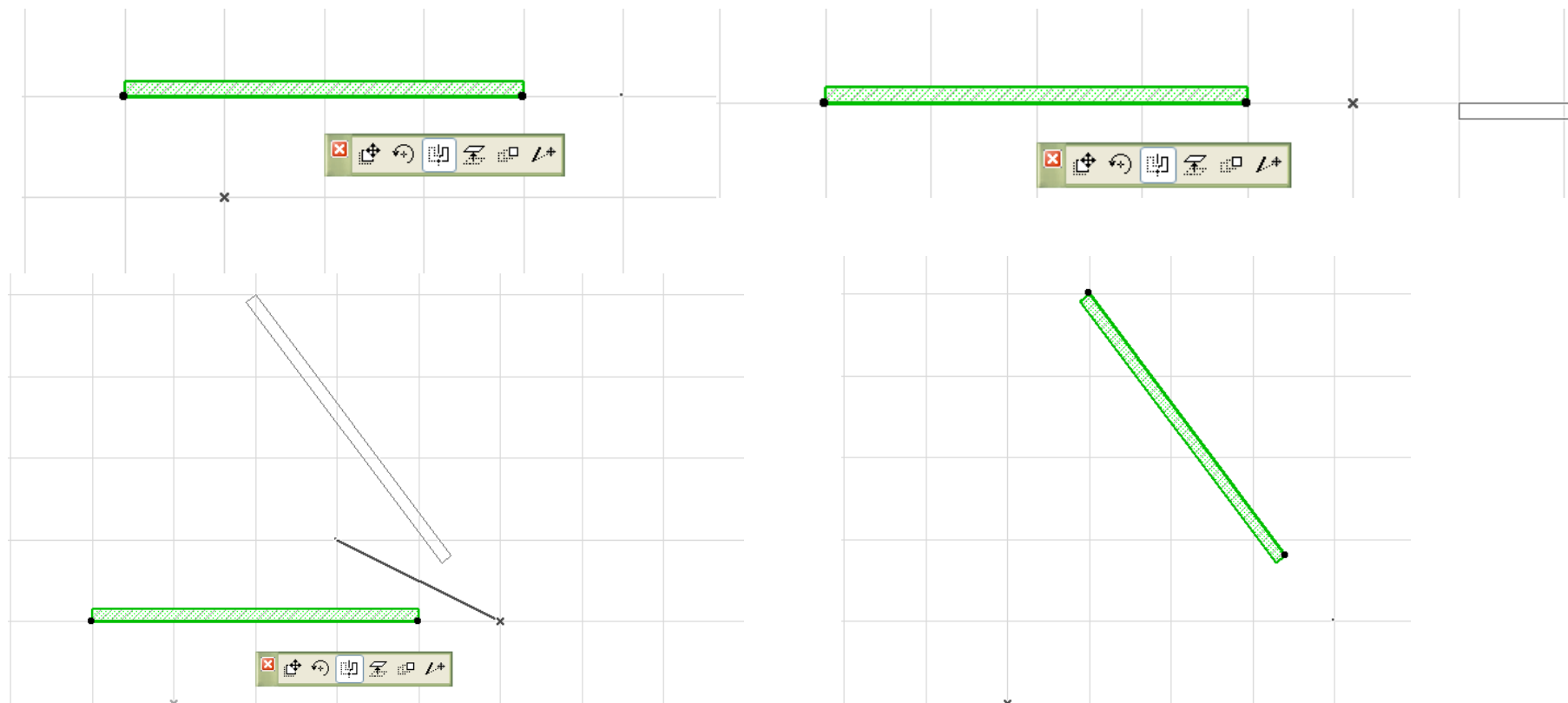

Пет палета - помоћна трака

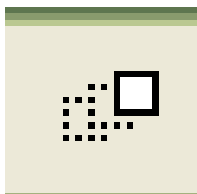

Multiply



Multiply [?] [X]

Choose an action:

Drag Rotate Elevate Matrix

Number of copies:

Vertical displacement:

Increment Distribute

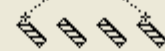
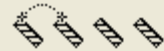

Spread... Distribute -1

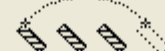
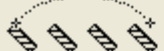

Cancel OK

Пет палета - помоћна трака

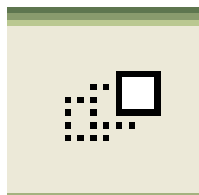

Multiply

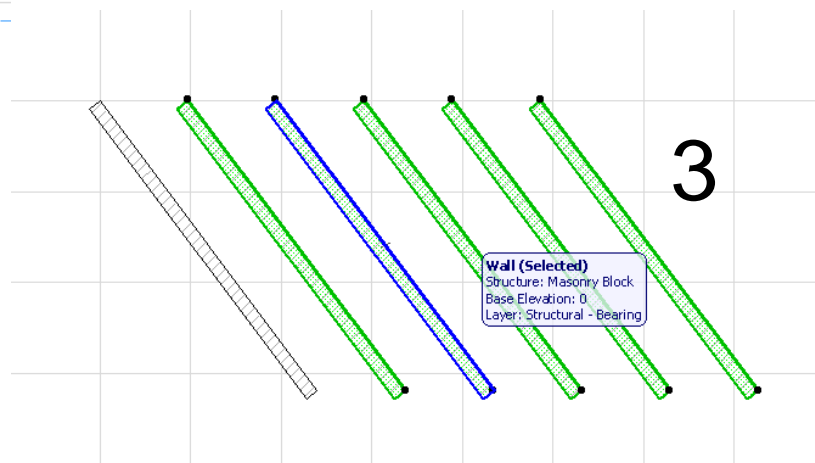
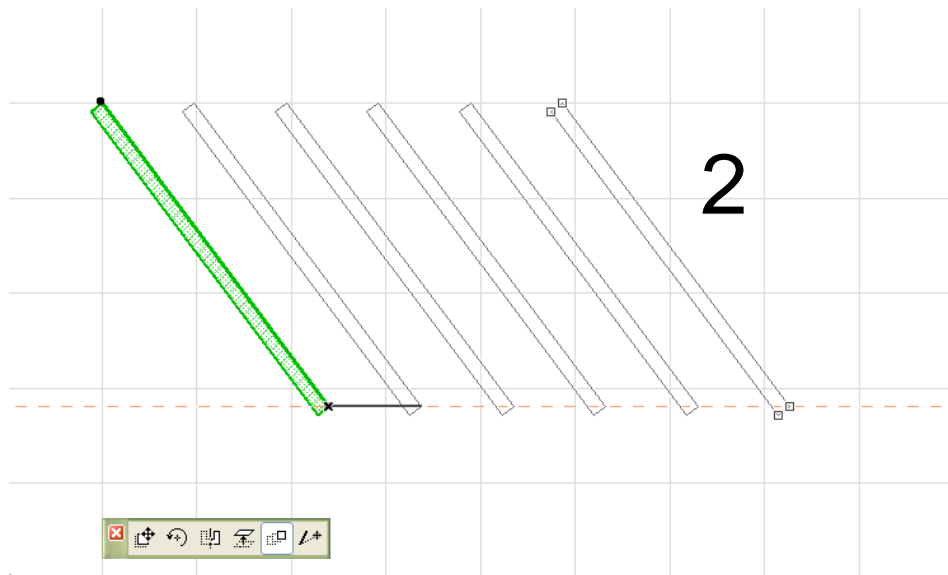
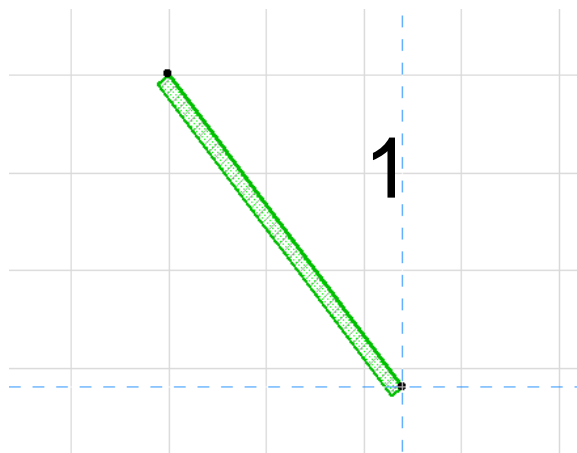

Пет палета - помоћна трака

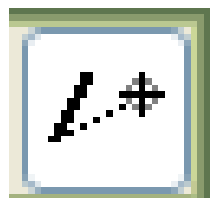

Stretch

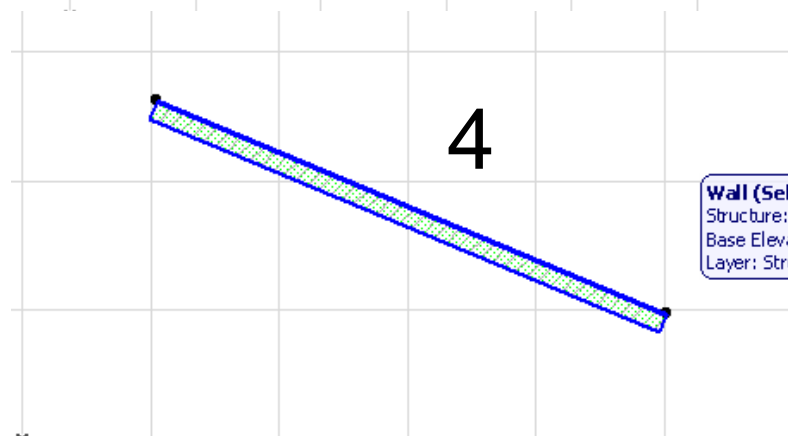
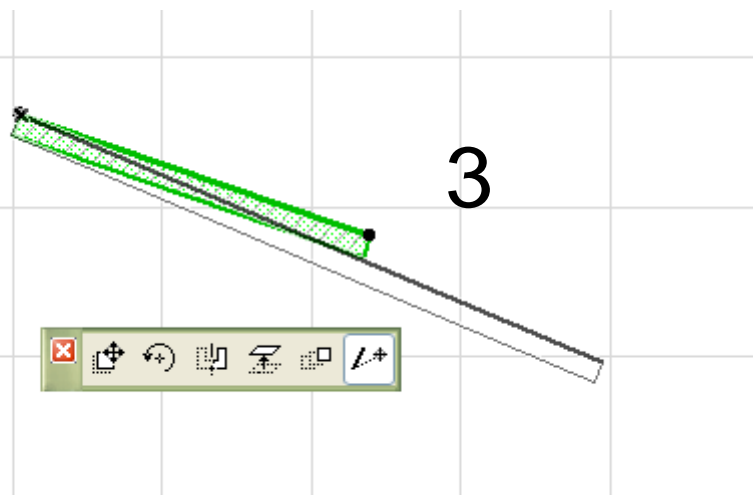
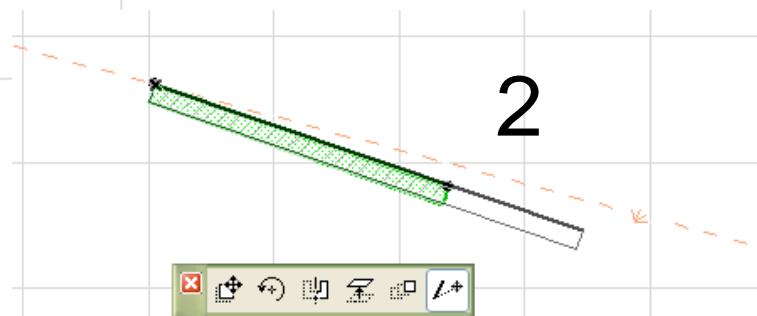
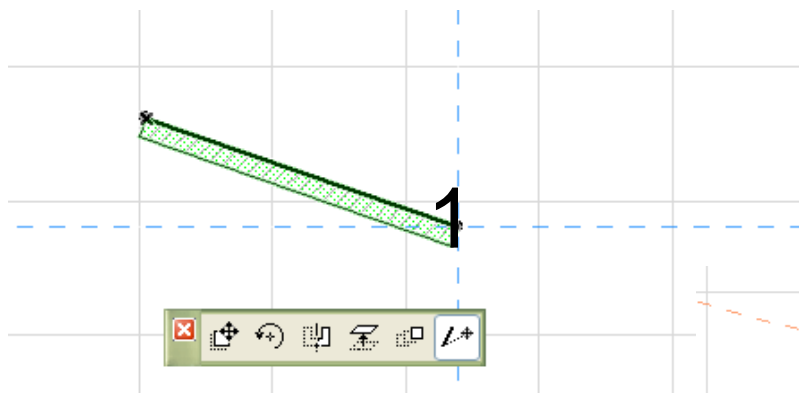

Цртање зидова по координатама

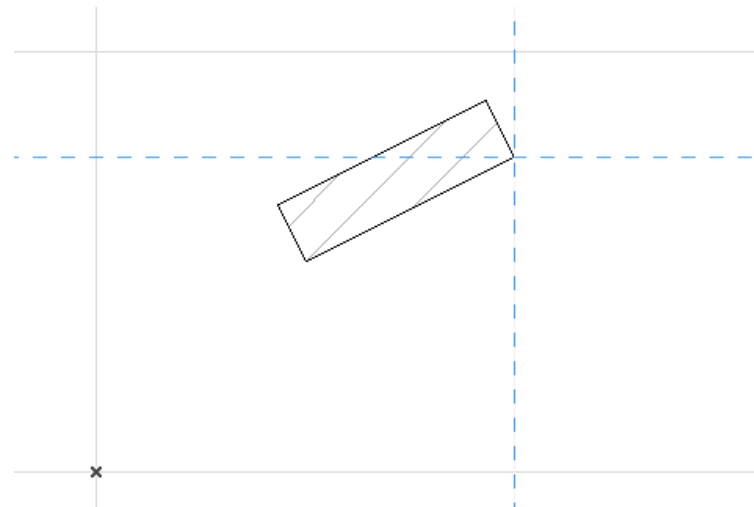
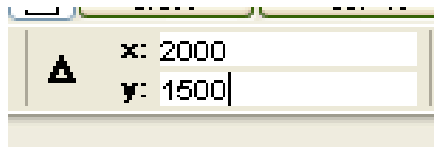
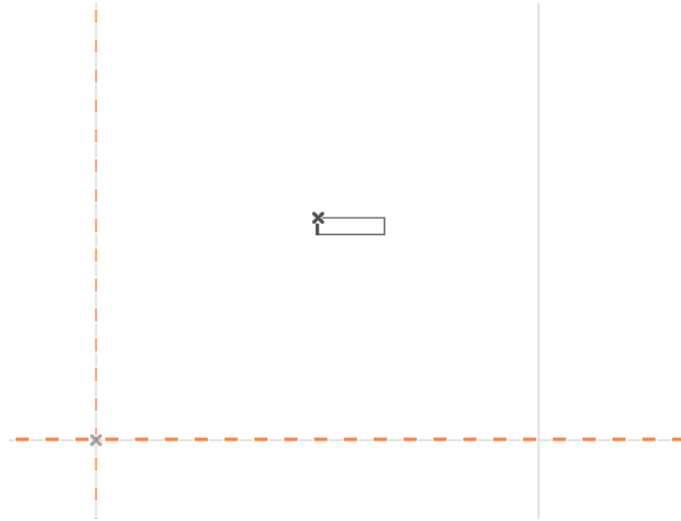
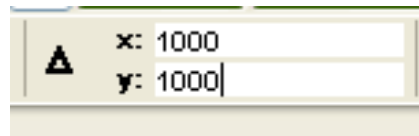

Чување врста зидова објекта у фаворитима

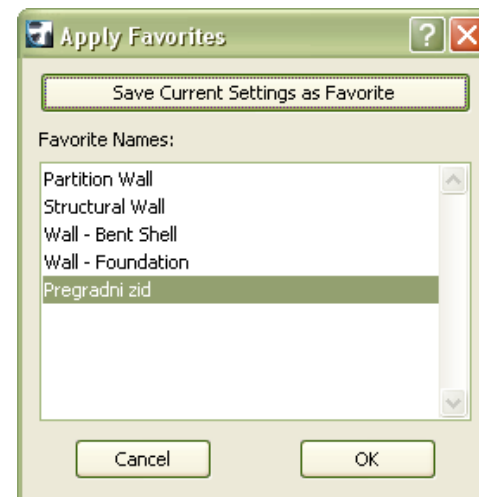
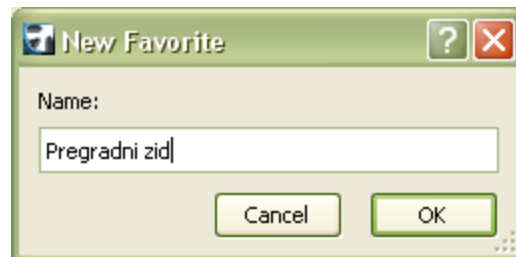
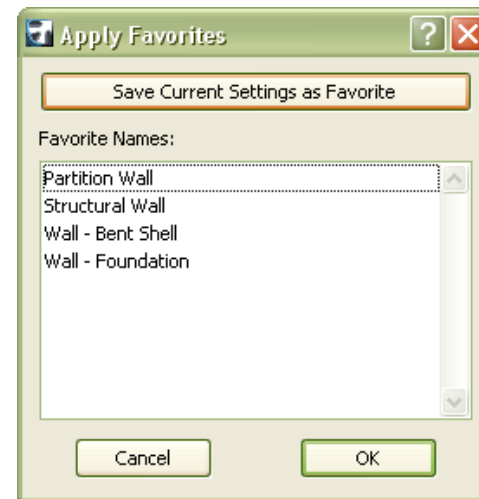
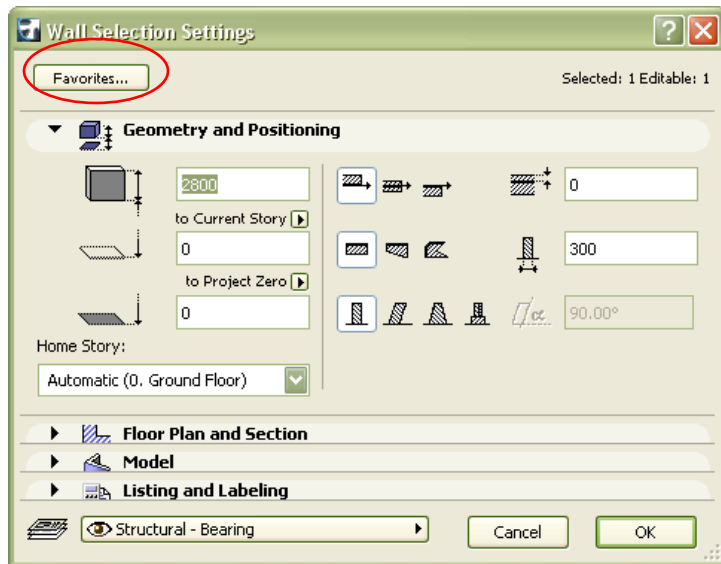

Цртање континуалних изломљених зидова

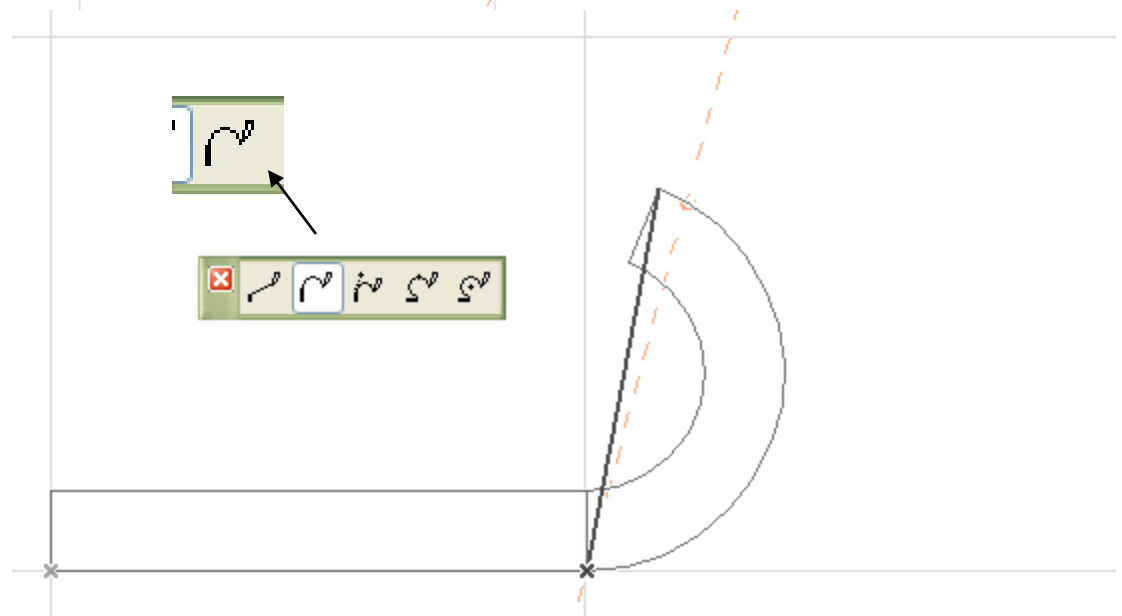
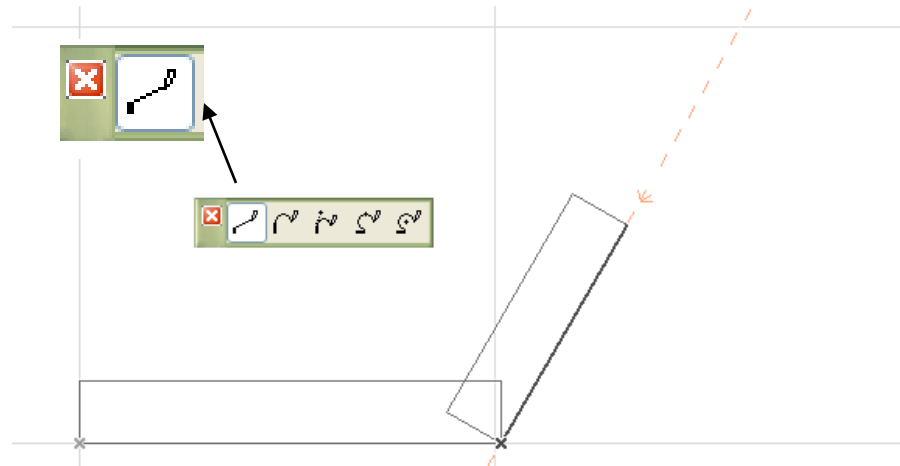
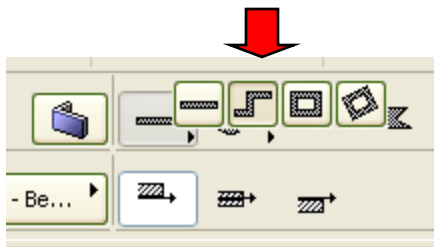

Цртање континуалних изломљених зидова

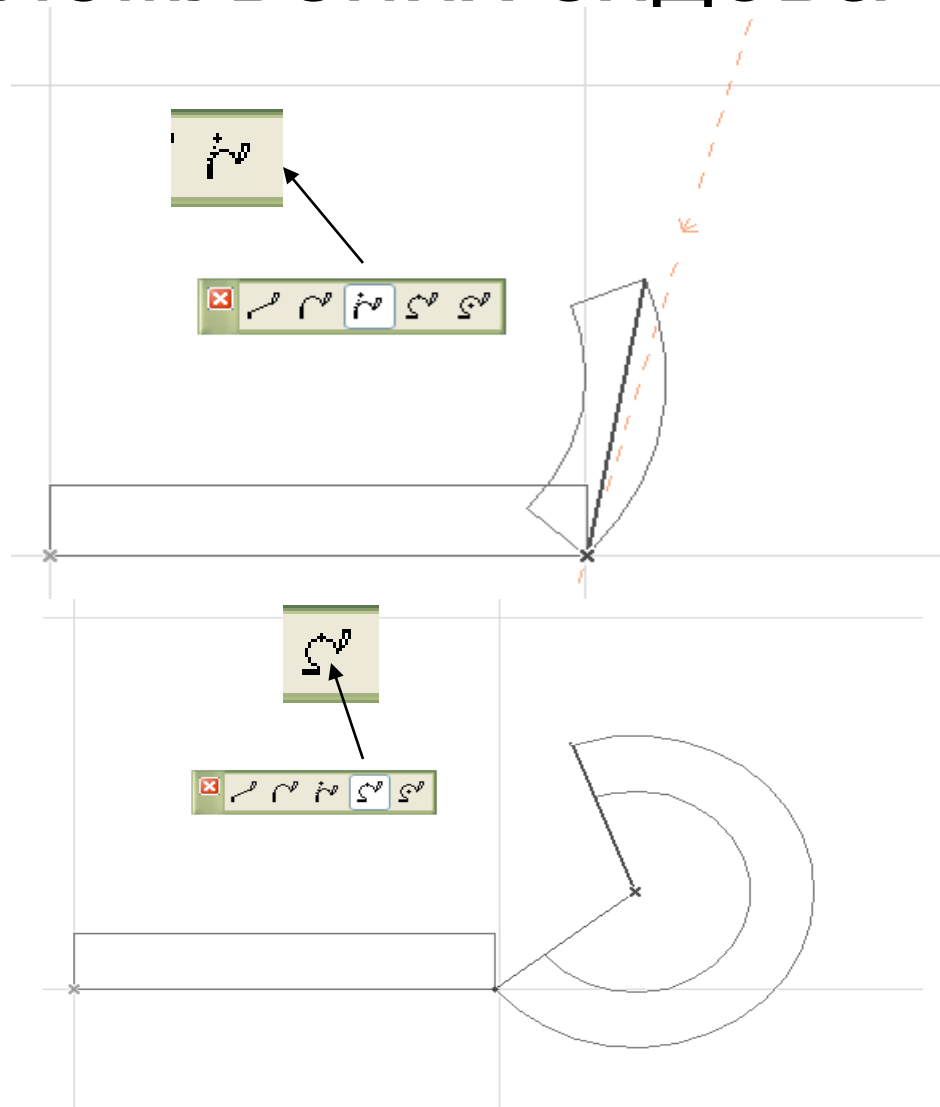
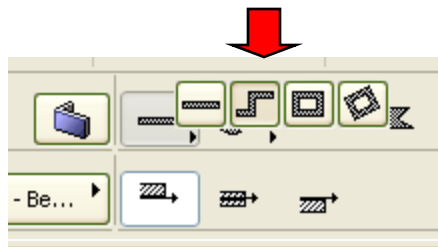

Цртање континуалних изломљених зидова

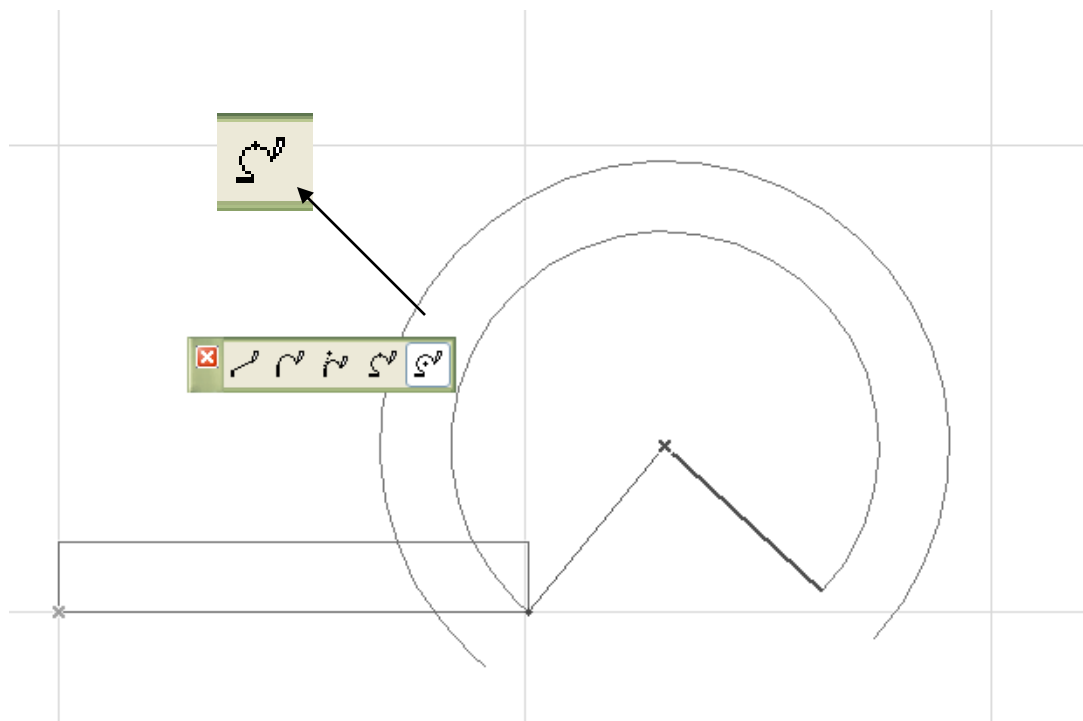
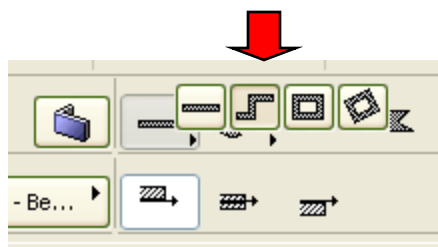

Цртање правоугаоних зидова

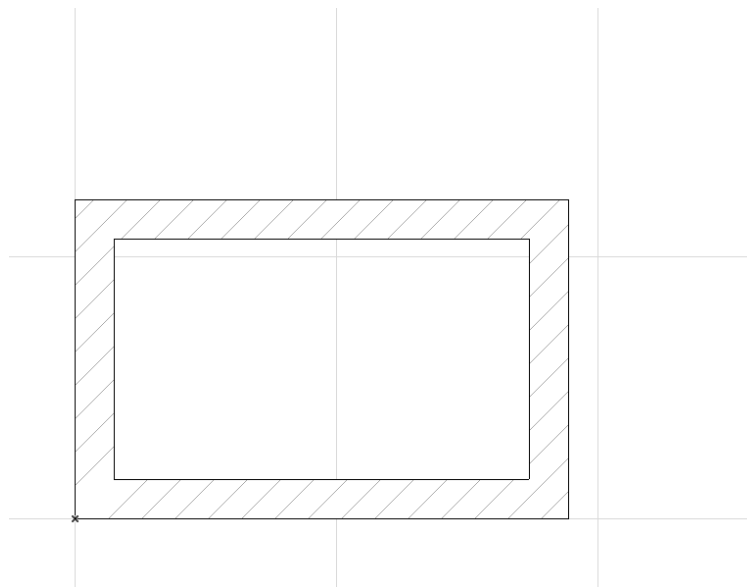
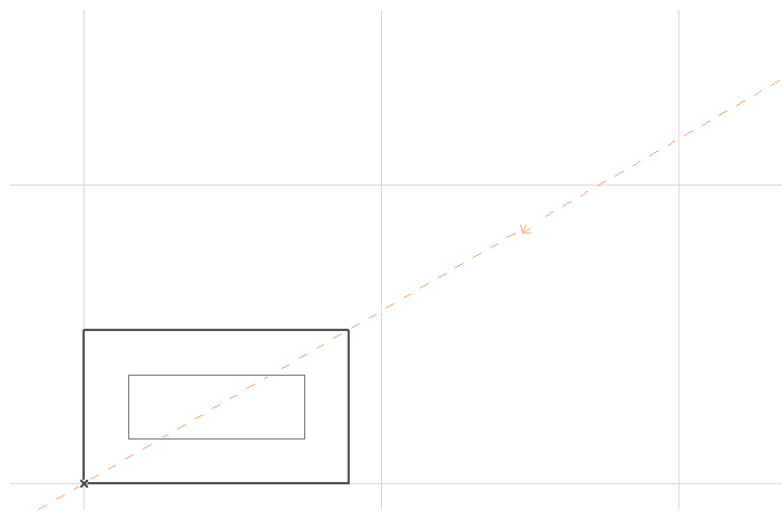
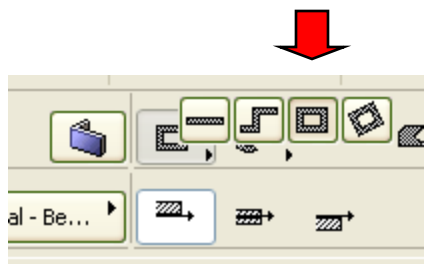

Цртање правоугаоних зидова под углом

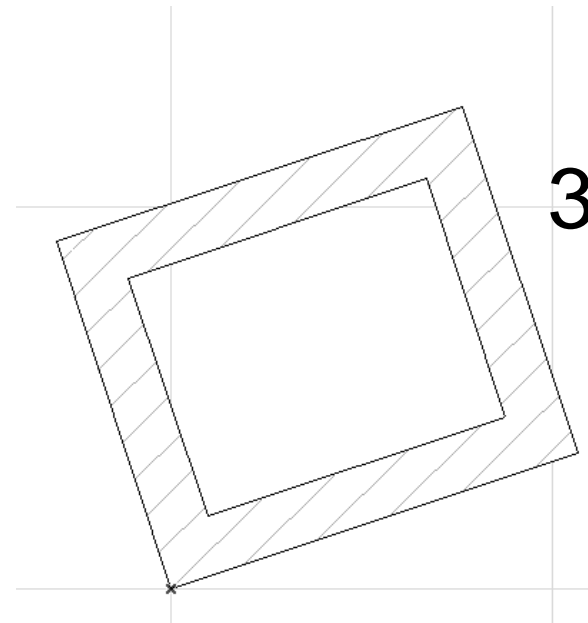
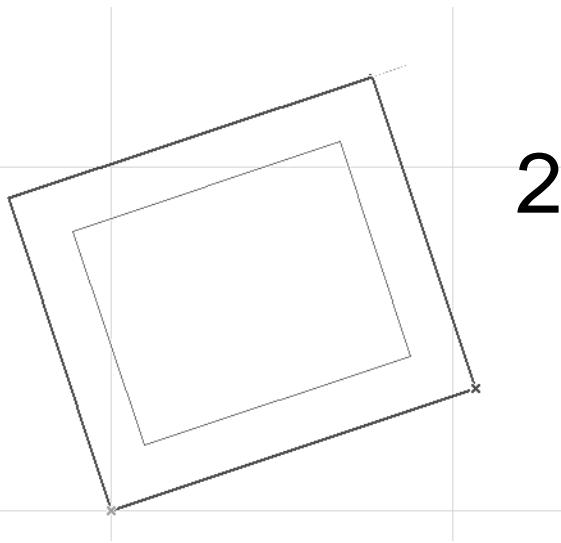
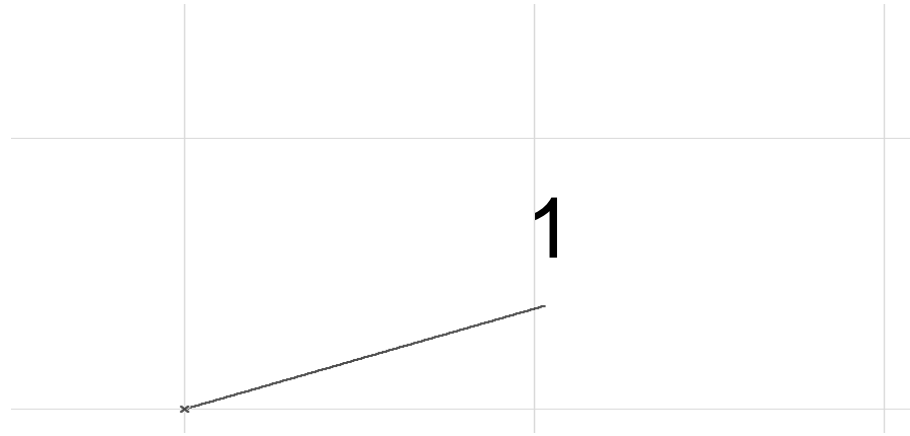
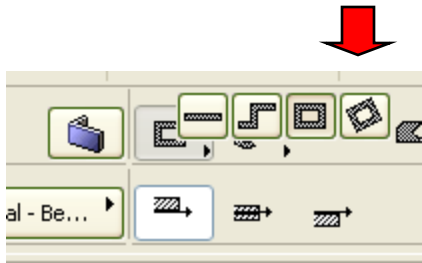

Груписање - раздвајање

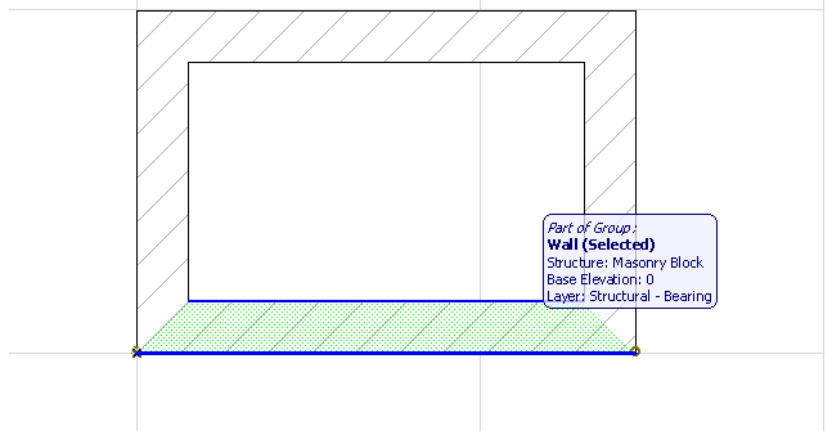
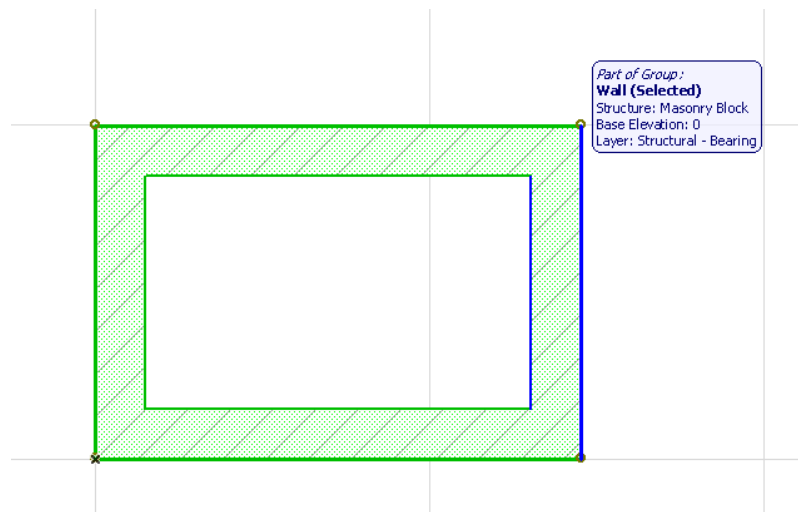

Цртање кружних зидова

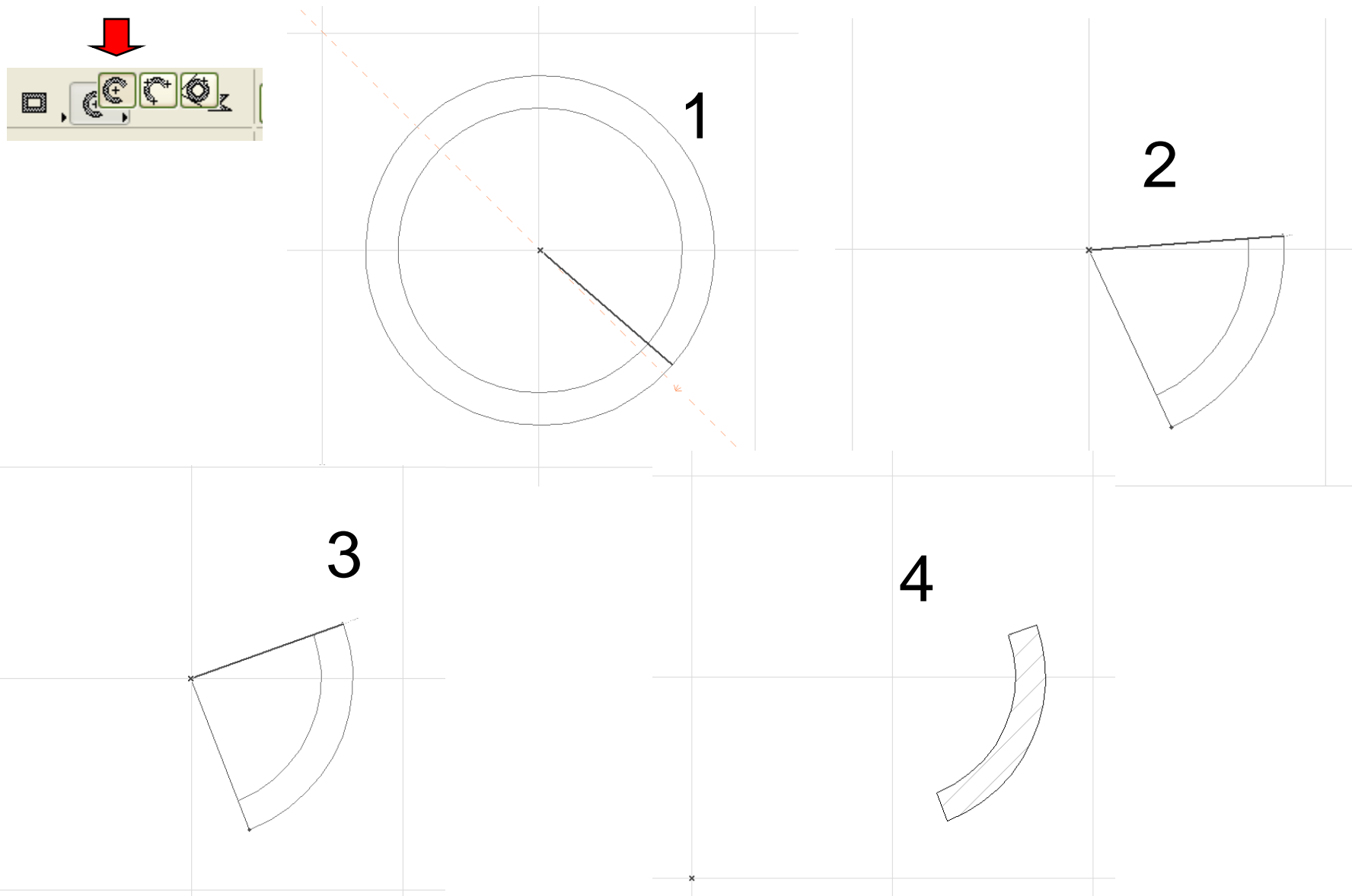

Цртање кружних зидова

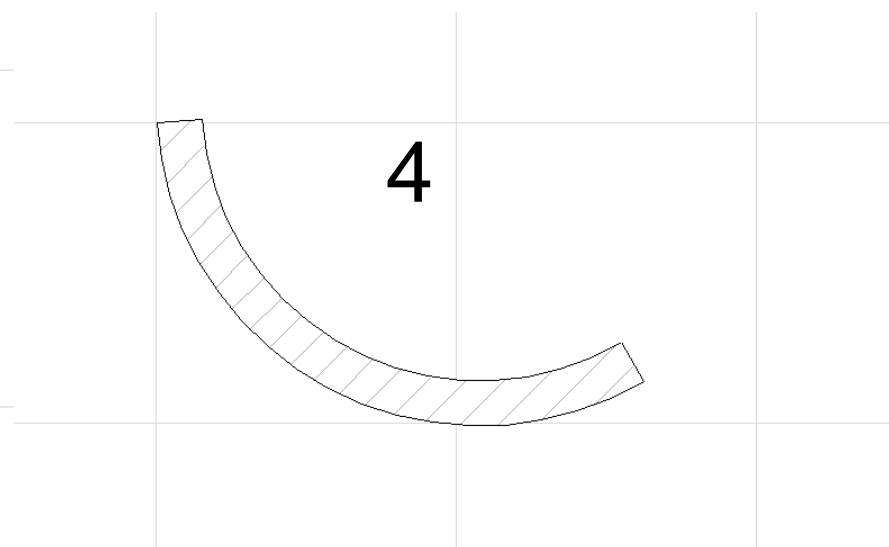
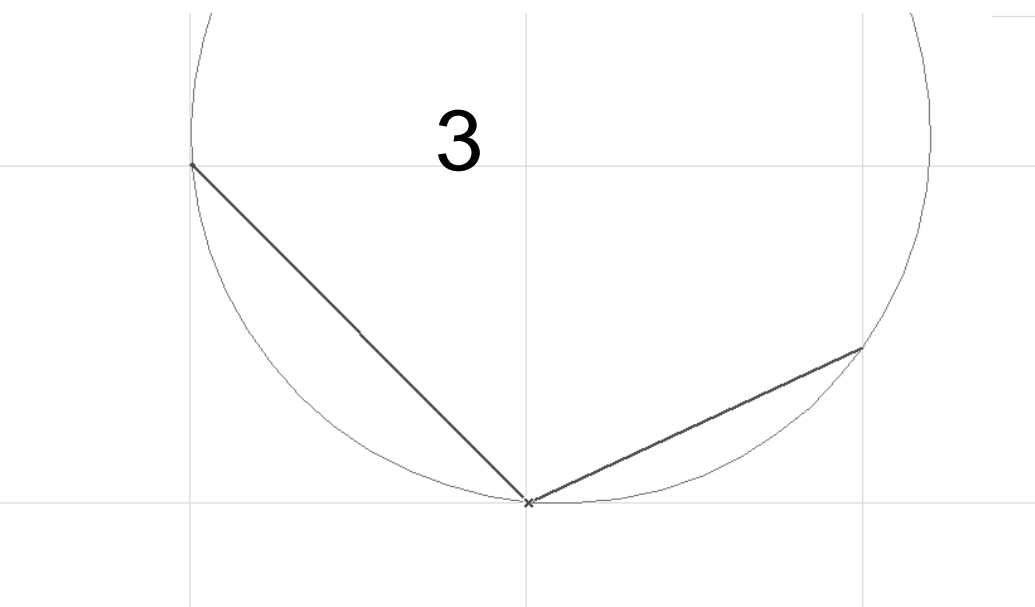
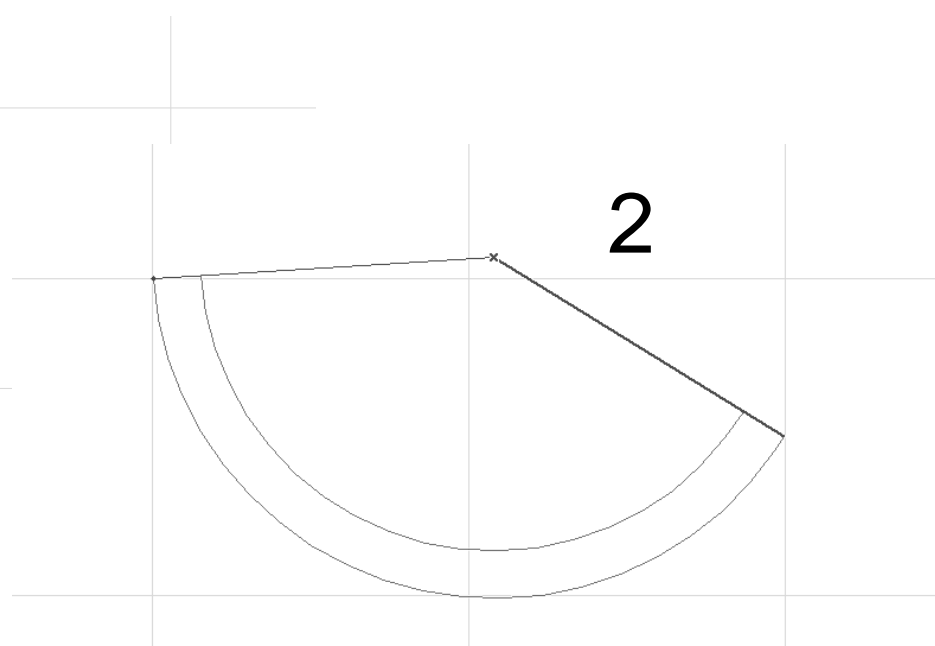
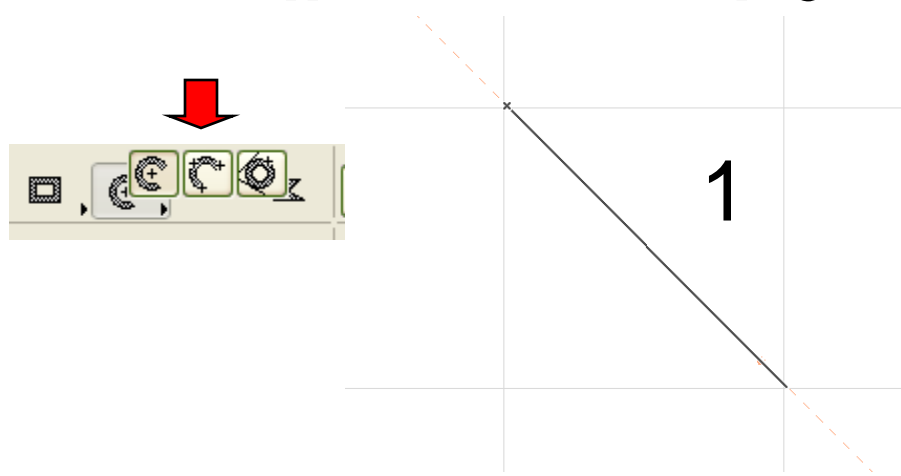

Зидови са променљивом дебљином

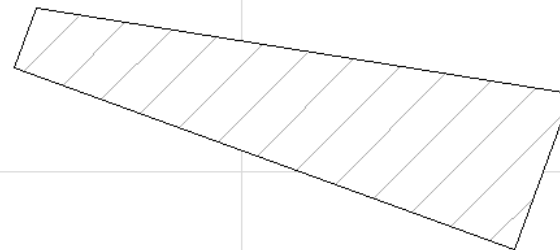
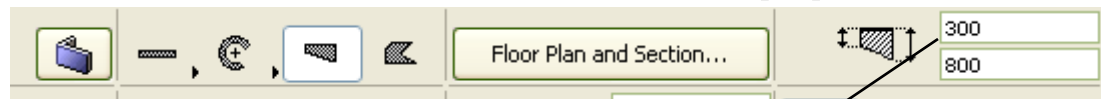

Плоче

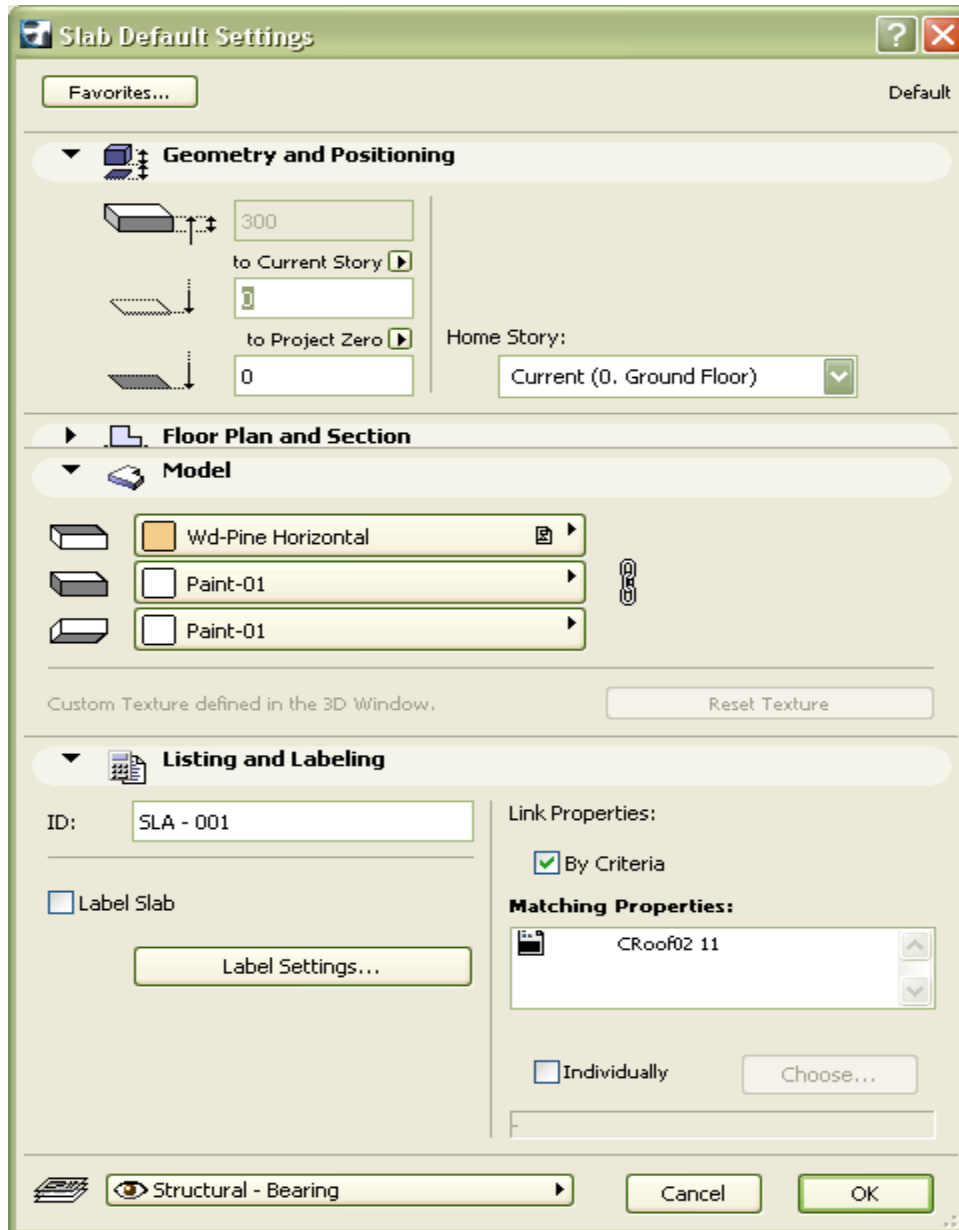

Цртање плоча

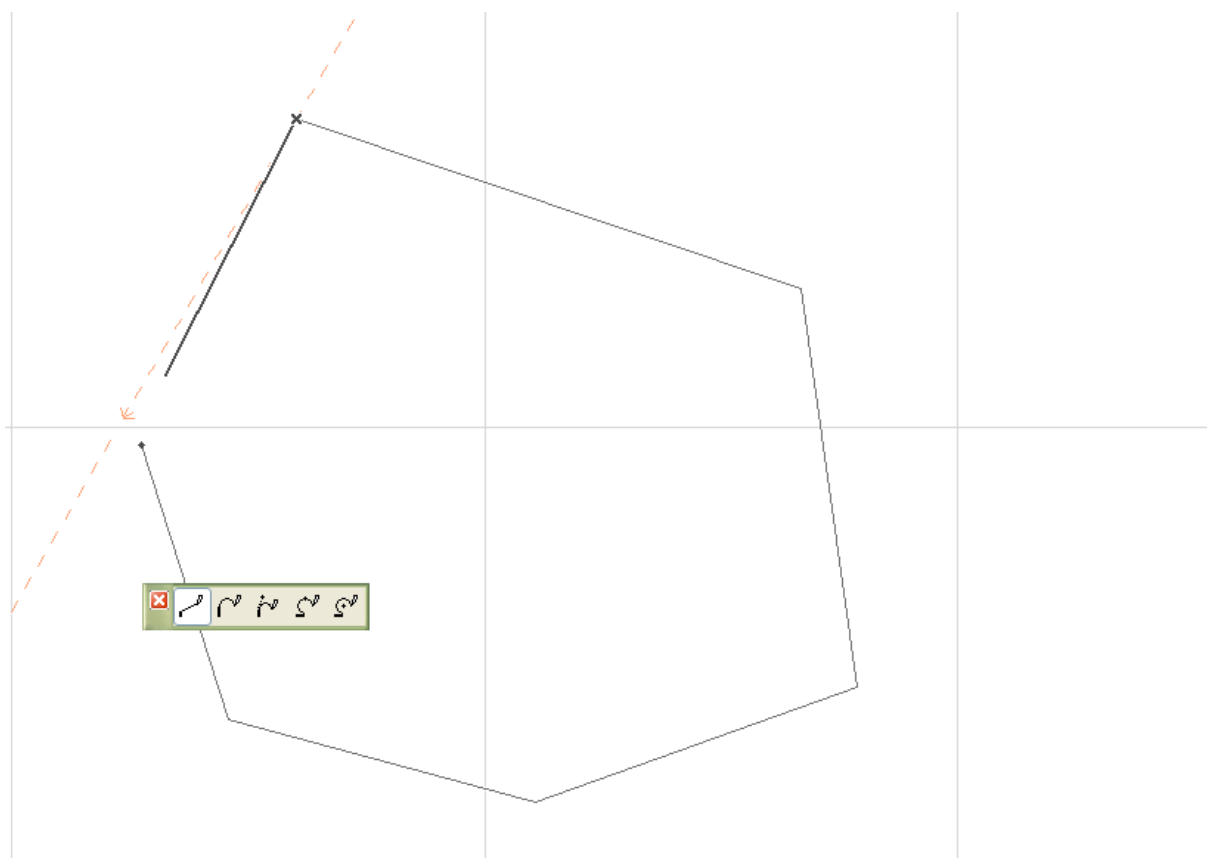
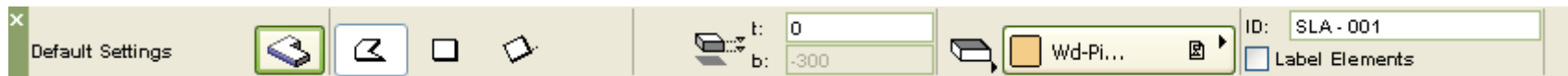

Цртање плоча

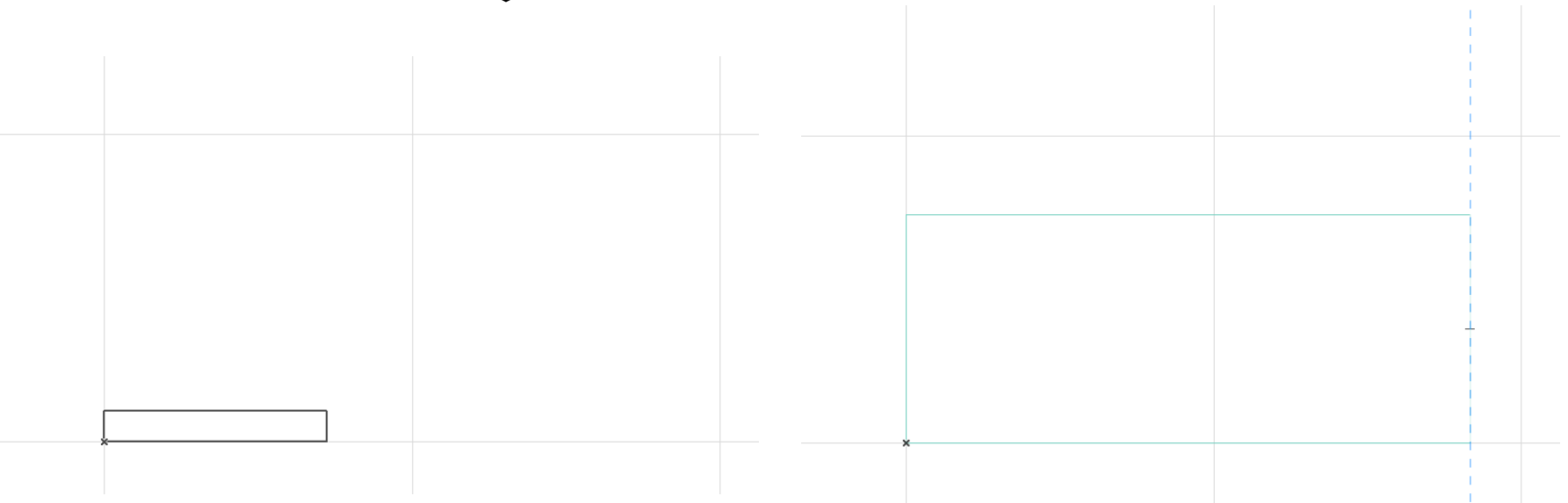
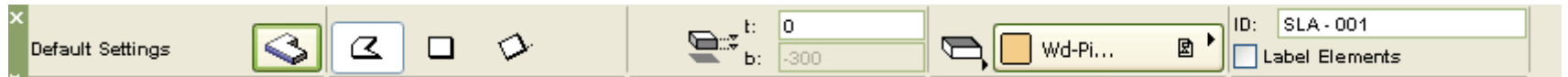

Цртање плоча

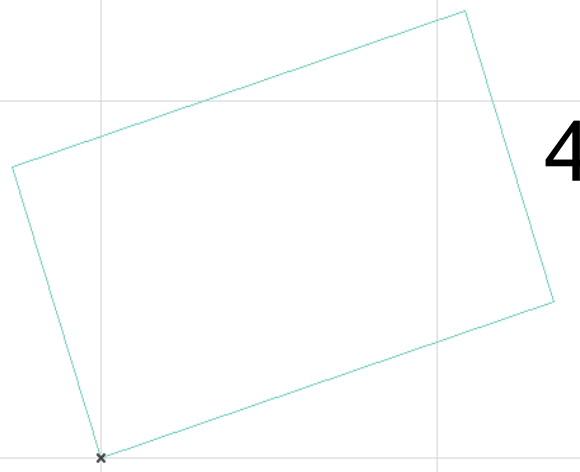
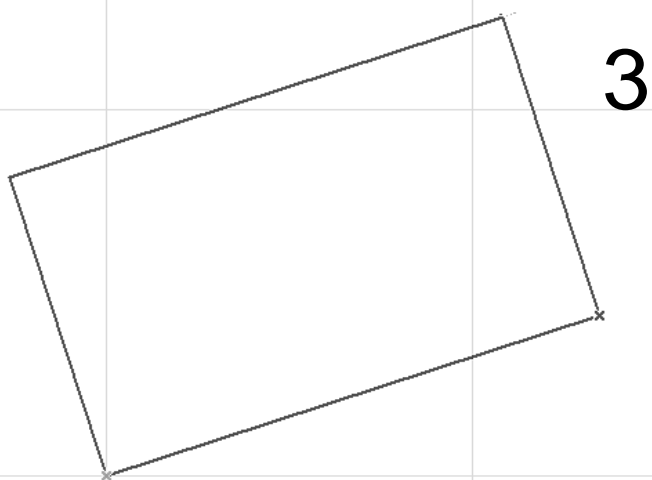
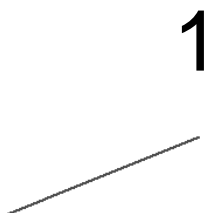
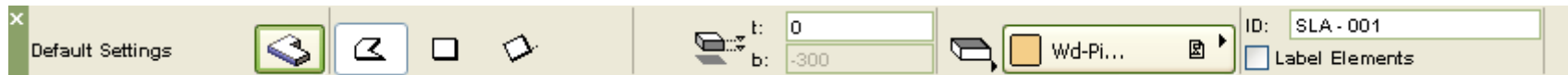

Цртање лукова на плочама

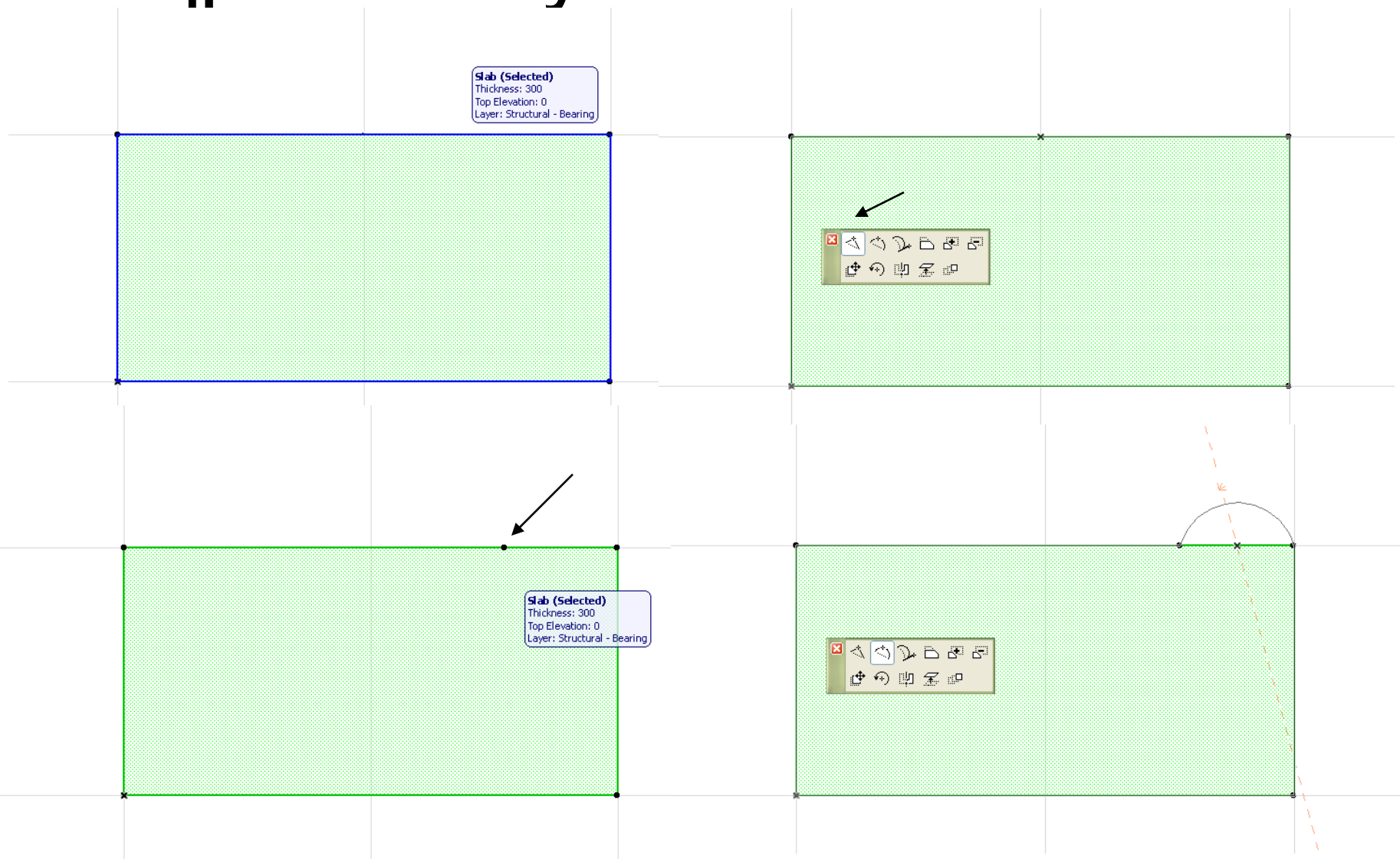

Модификовање плоча

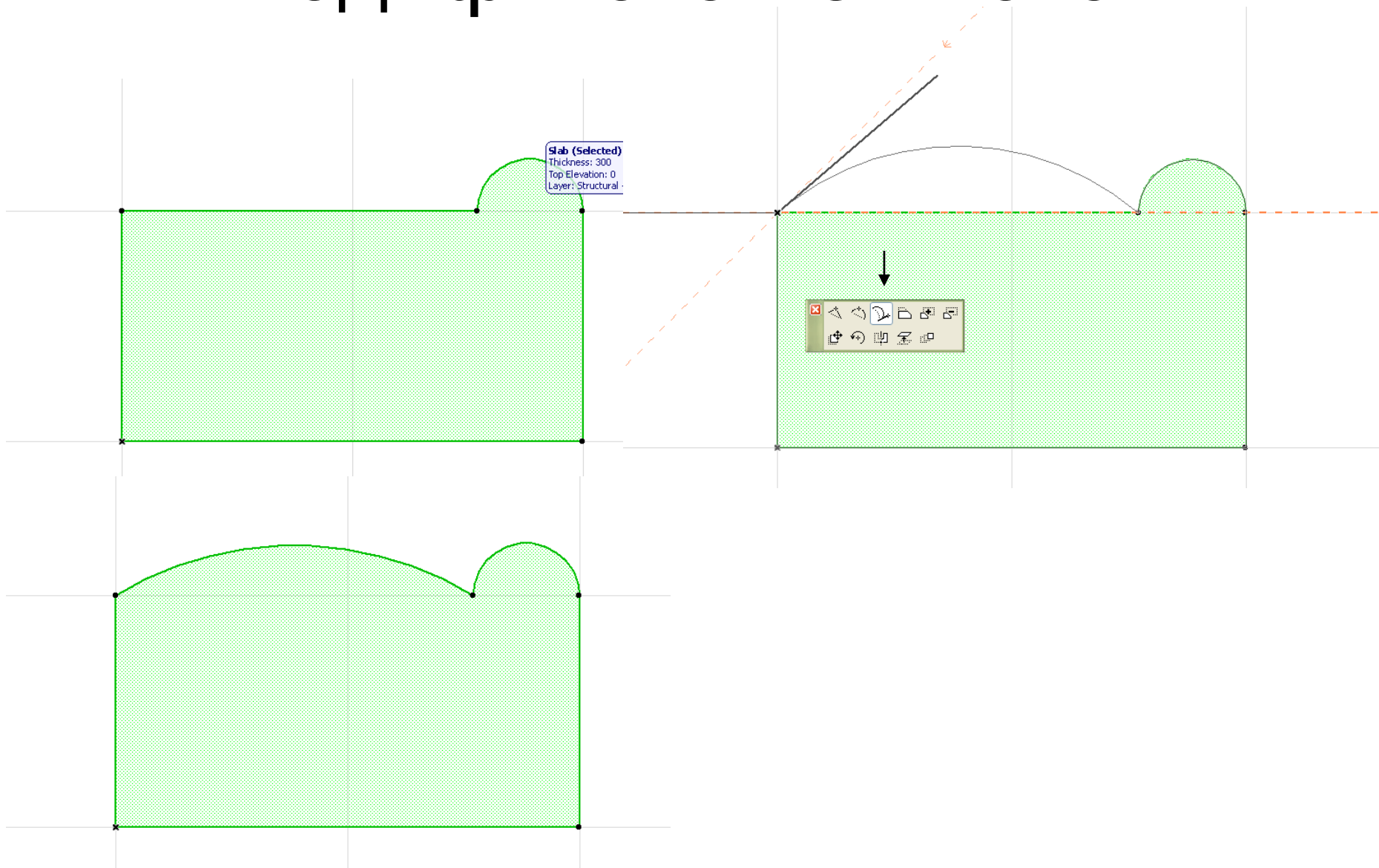

Модификовање плоча

Slab (Selected)
Thickness: 300
Top Elevation: 0
Layer: Structural - Bearing

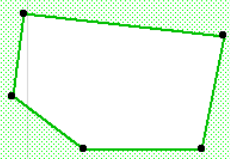

Модификовање плоча

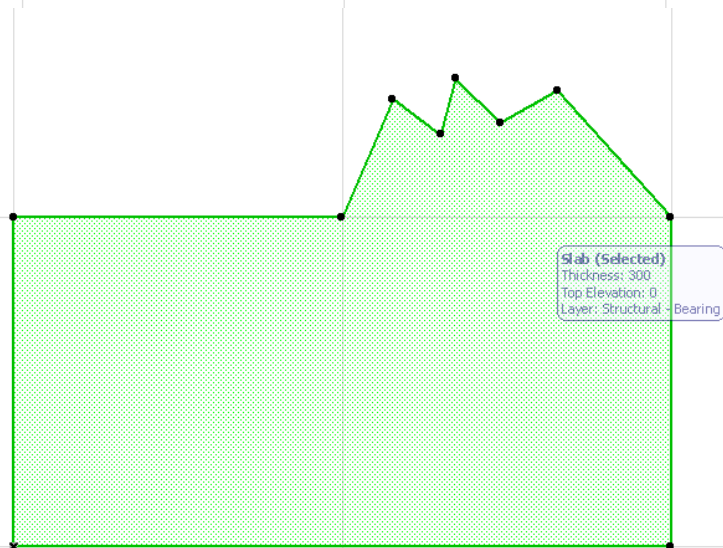
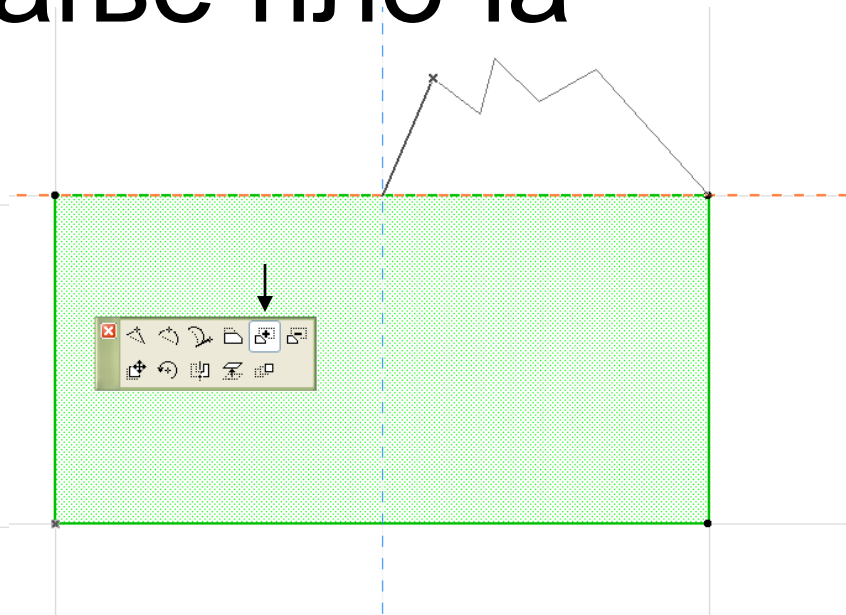
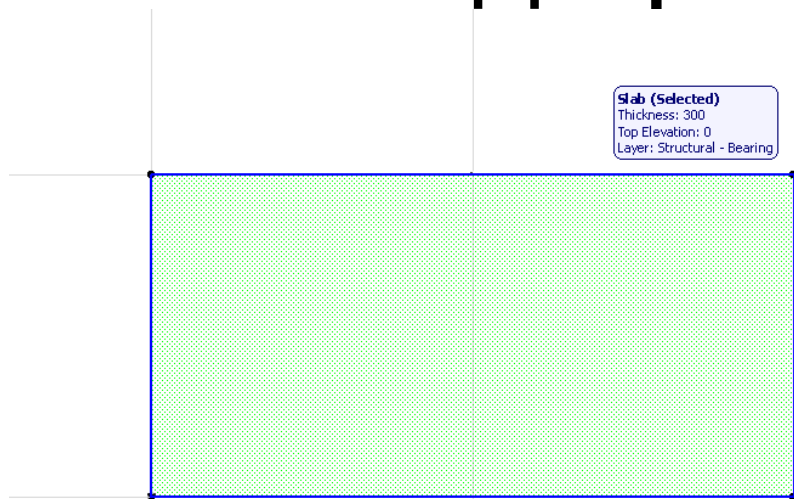

Коришћење магичног штапића

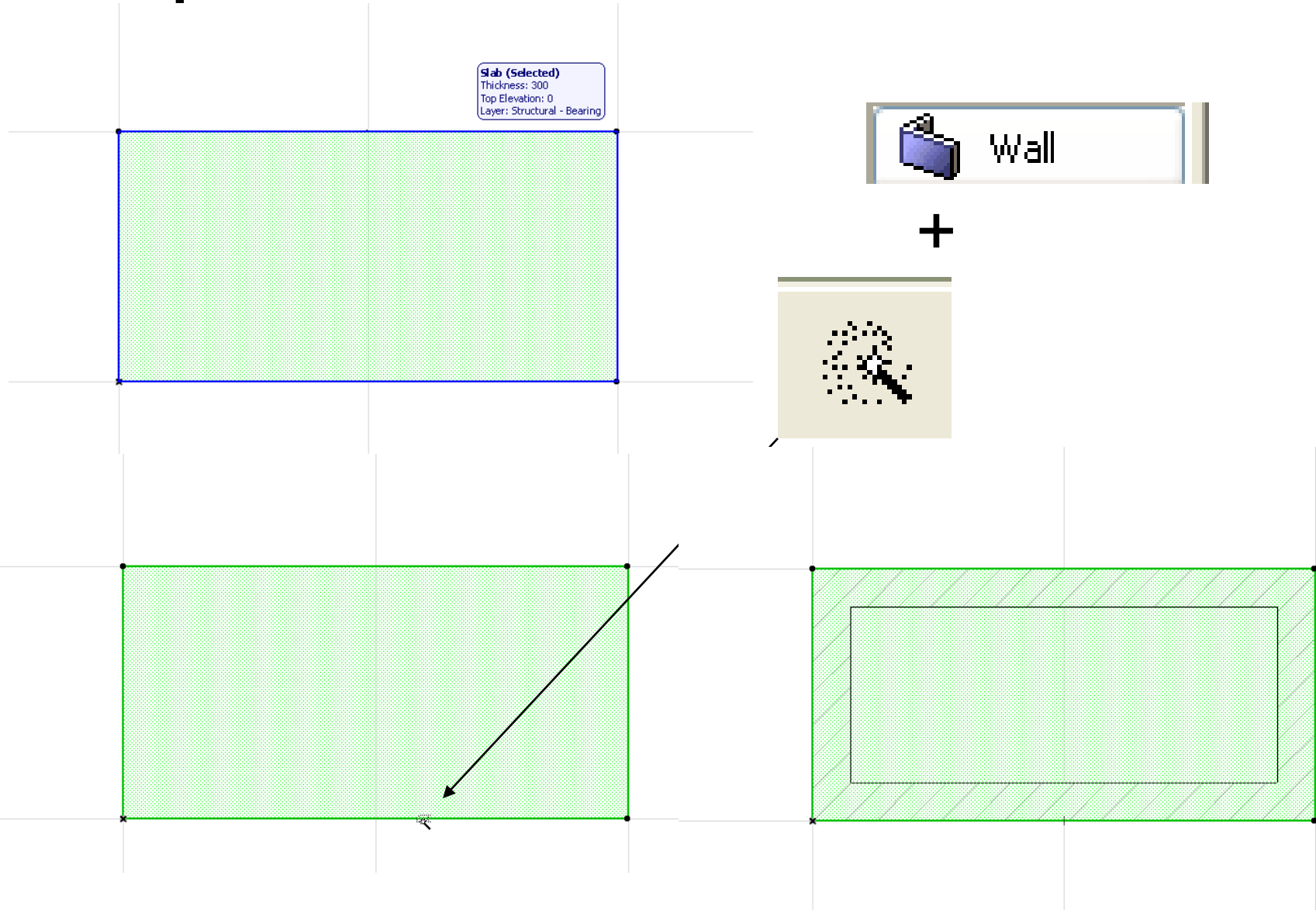

Дељење зидова на више делова

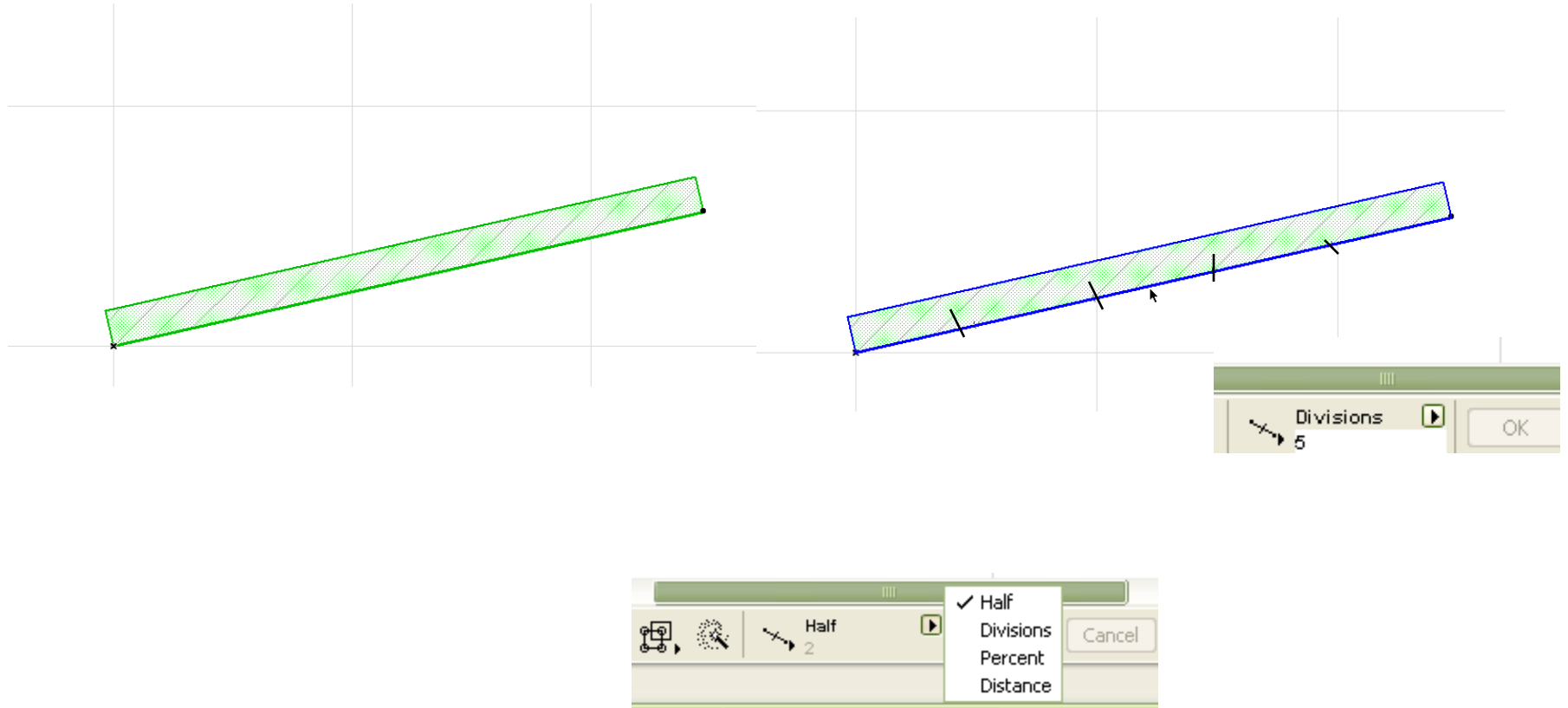

Кривљење зида под косином

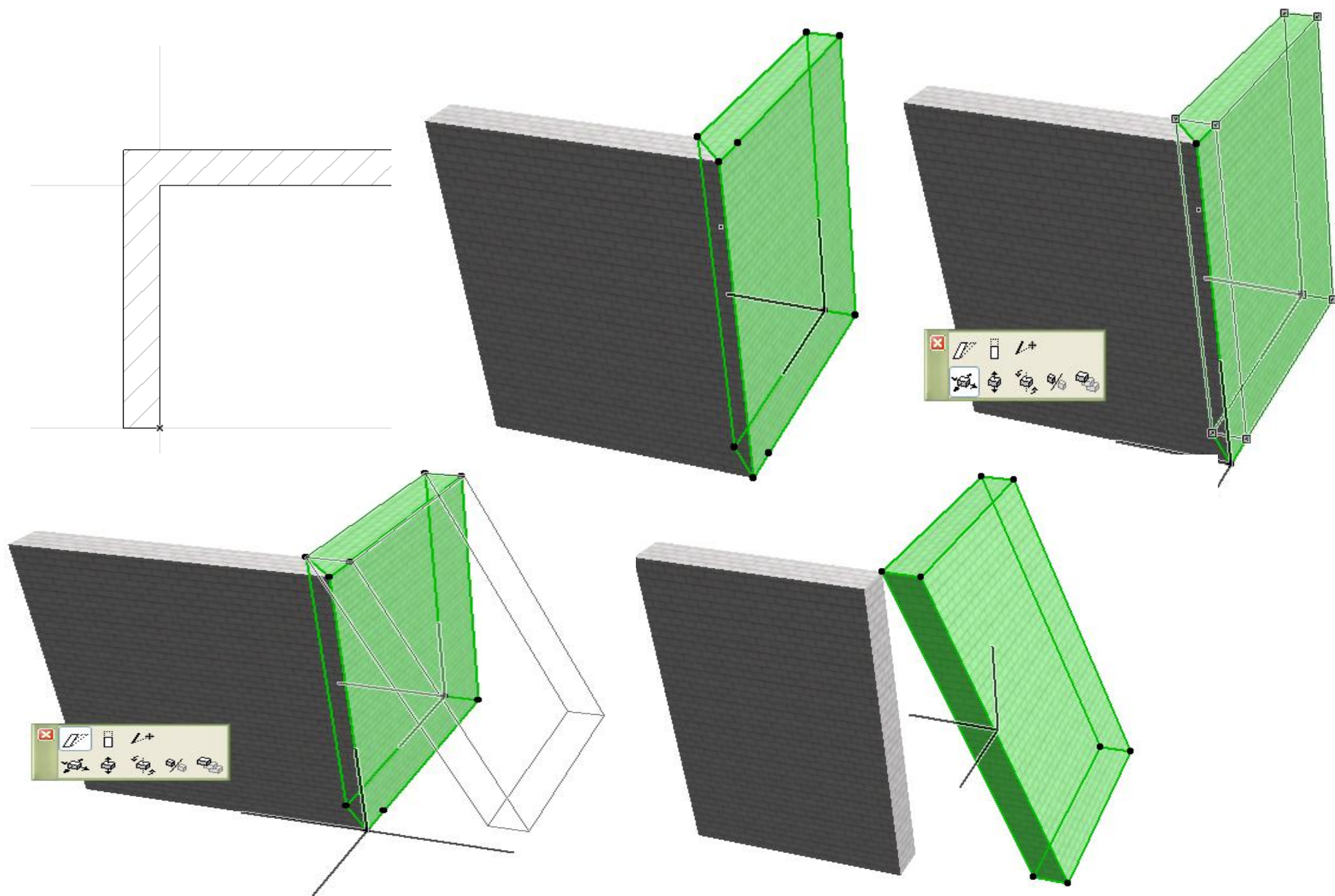

Мењање висине зидова

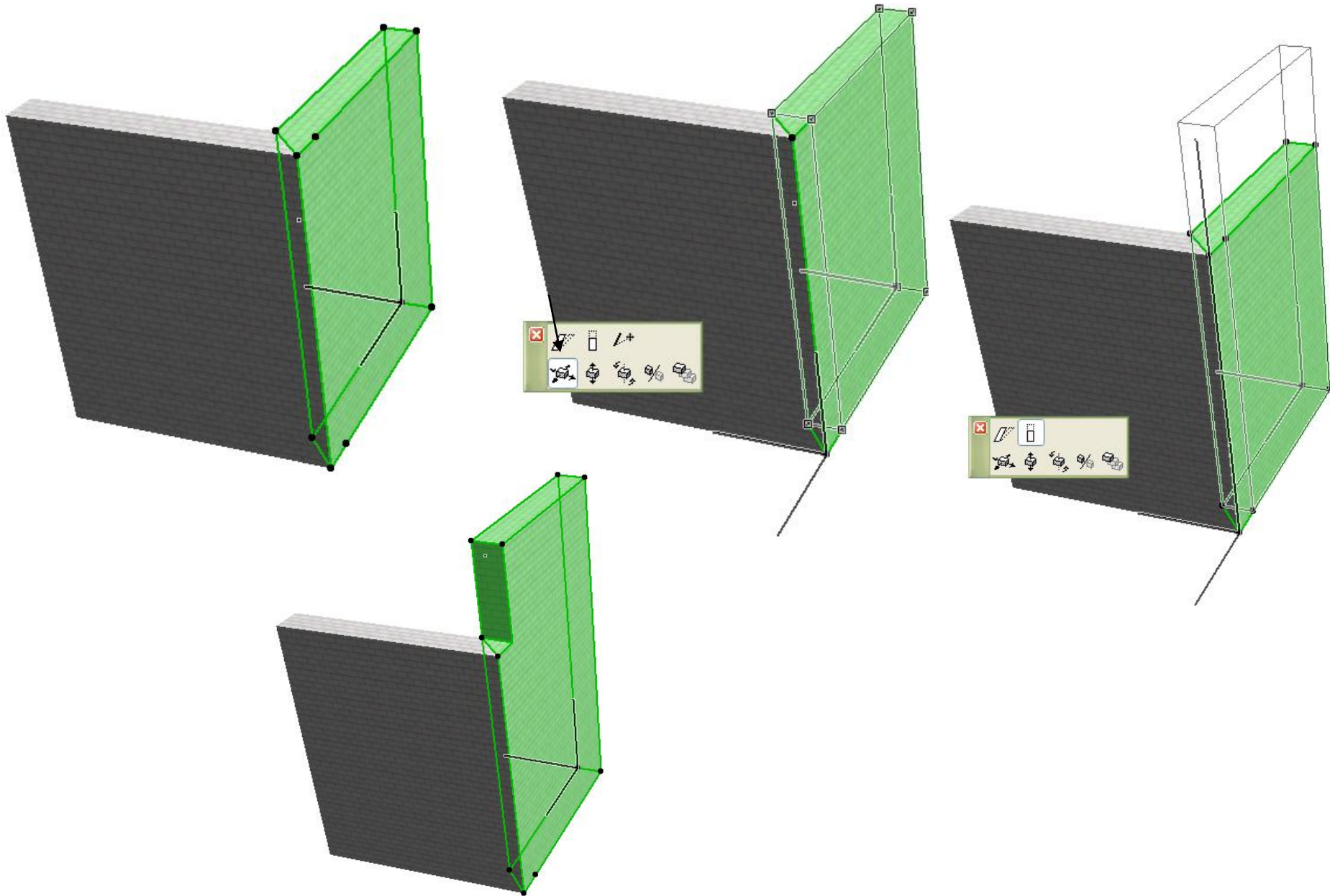

Померање зидова по равни

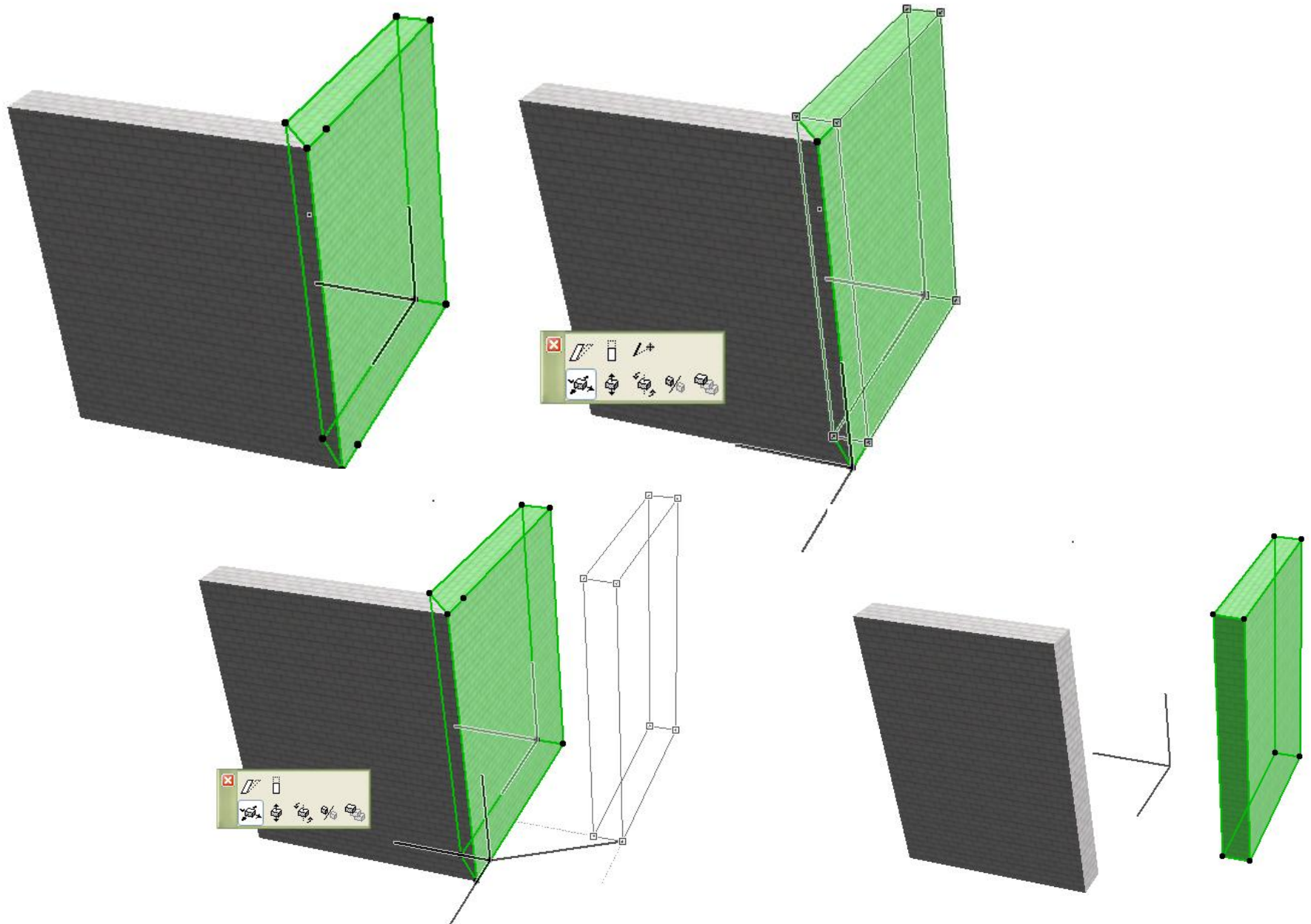

Померање зидова по висини

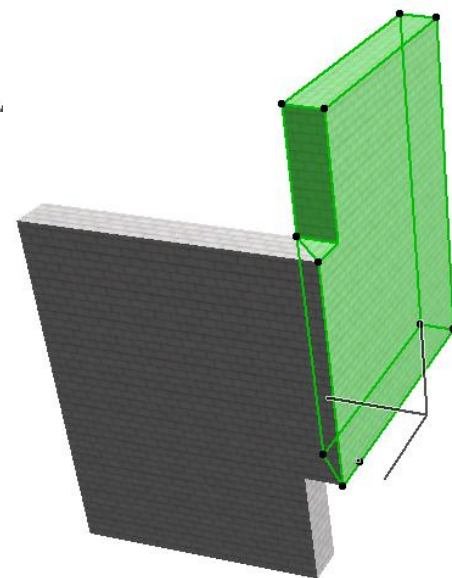
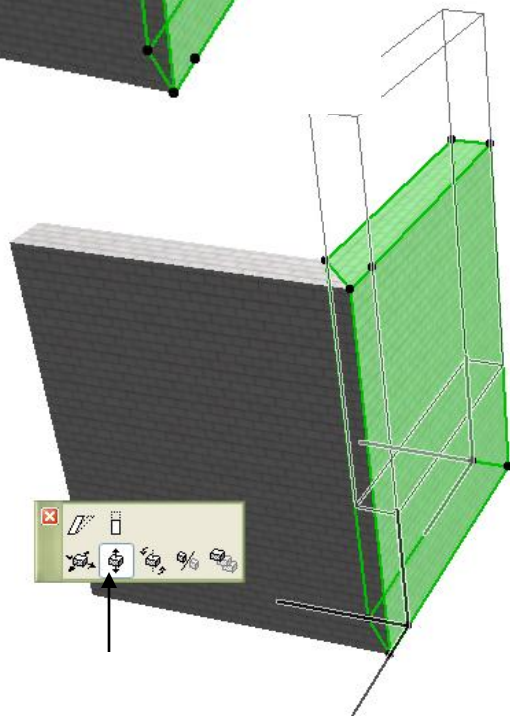
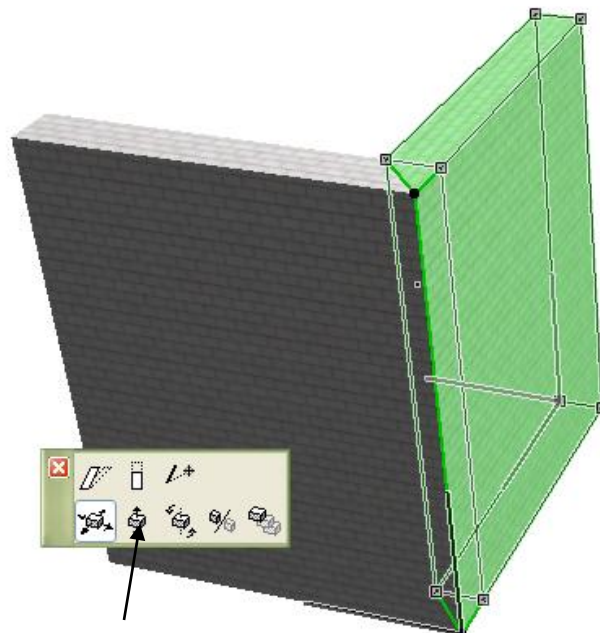
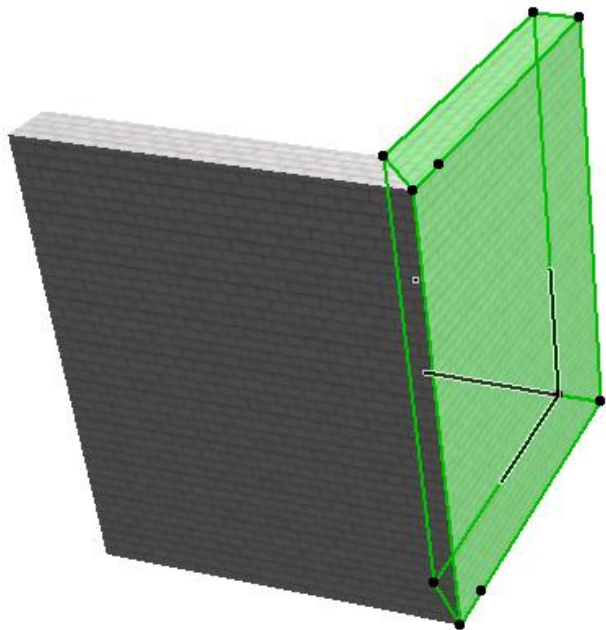

Ротирање зидова

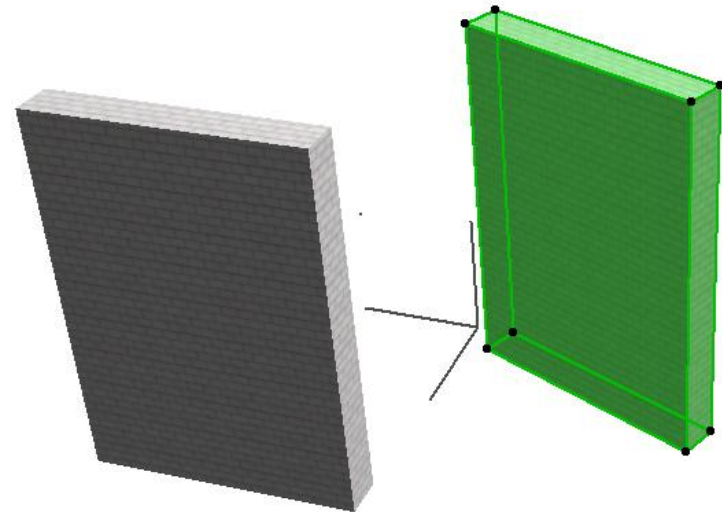
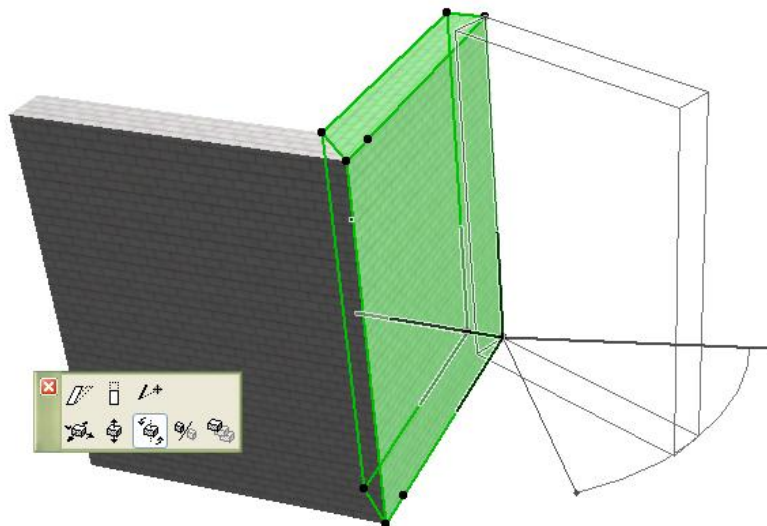
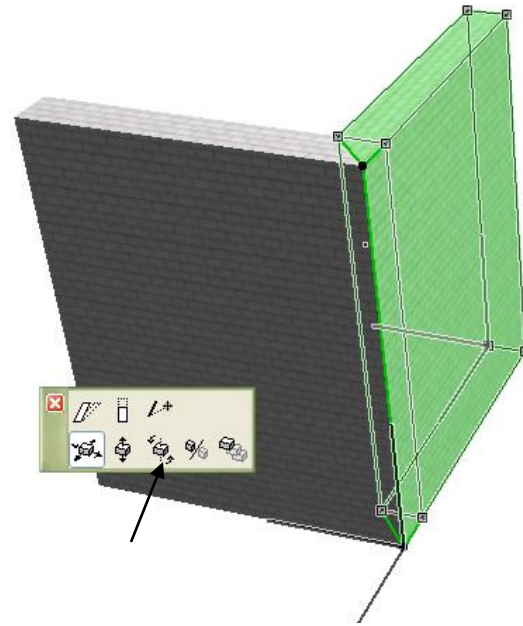
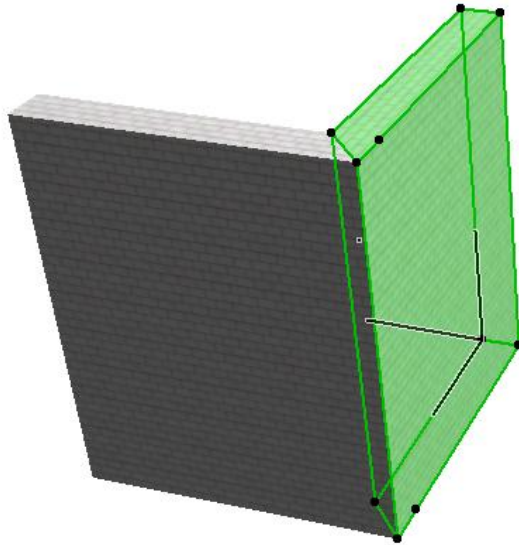

Чување приказа који тренутно видимо у 3D прозору

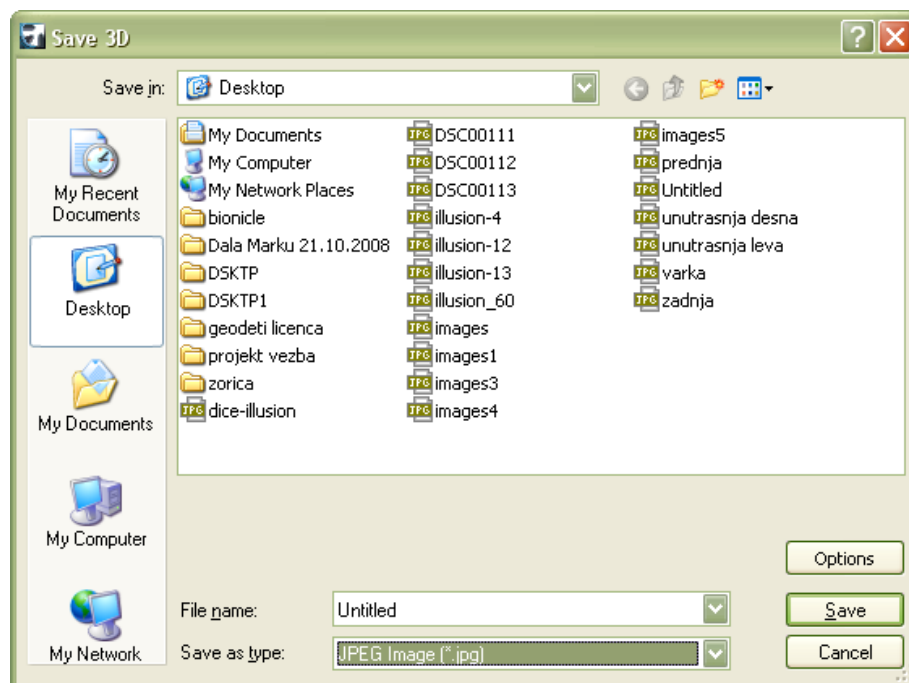

Спратови (stories)

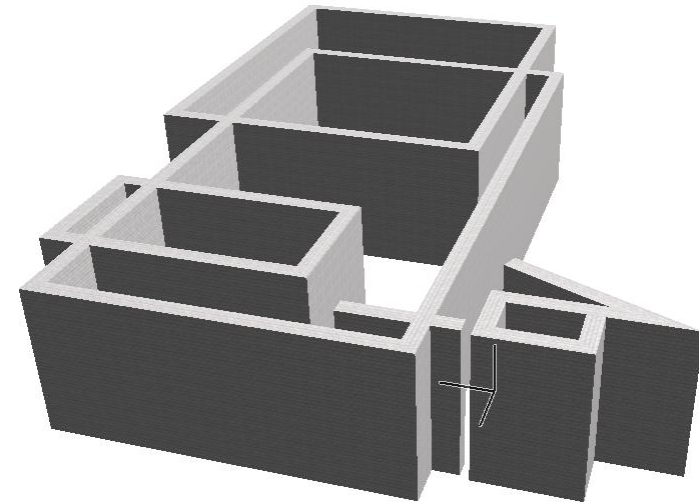
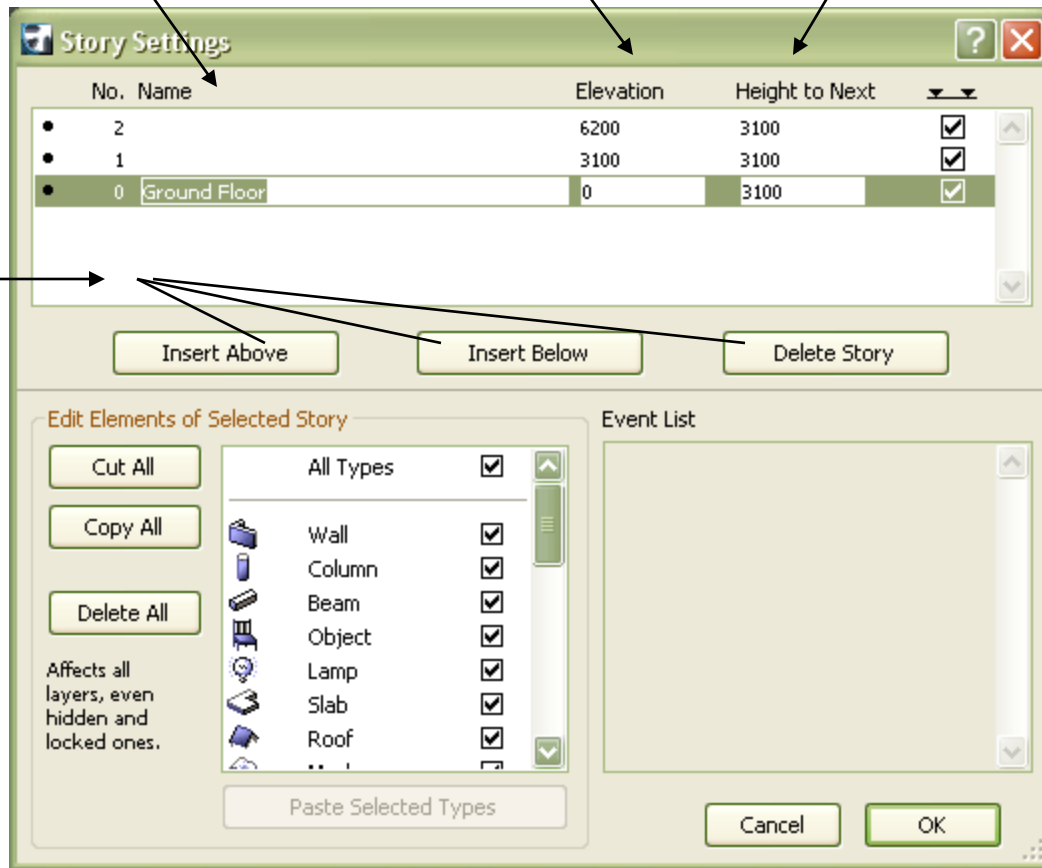

Копирање спратова - етажа

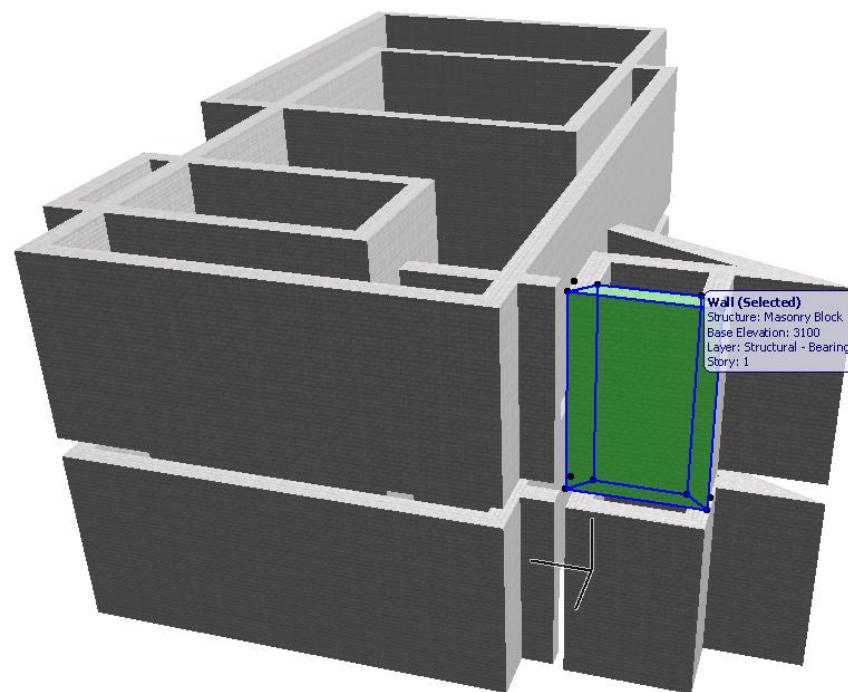
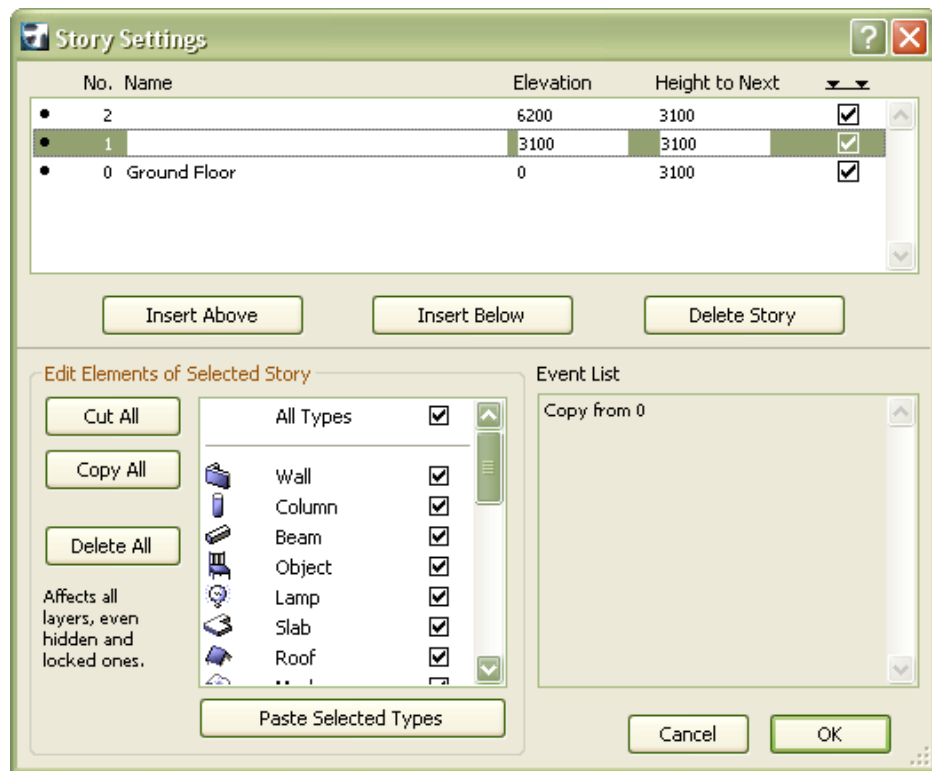

1. COPY ALL
2. Selekcija etaže
3. PASTE SELECTED TYPES

Лејери

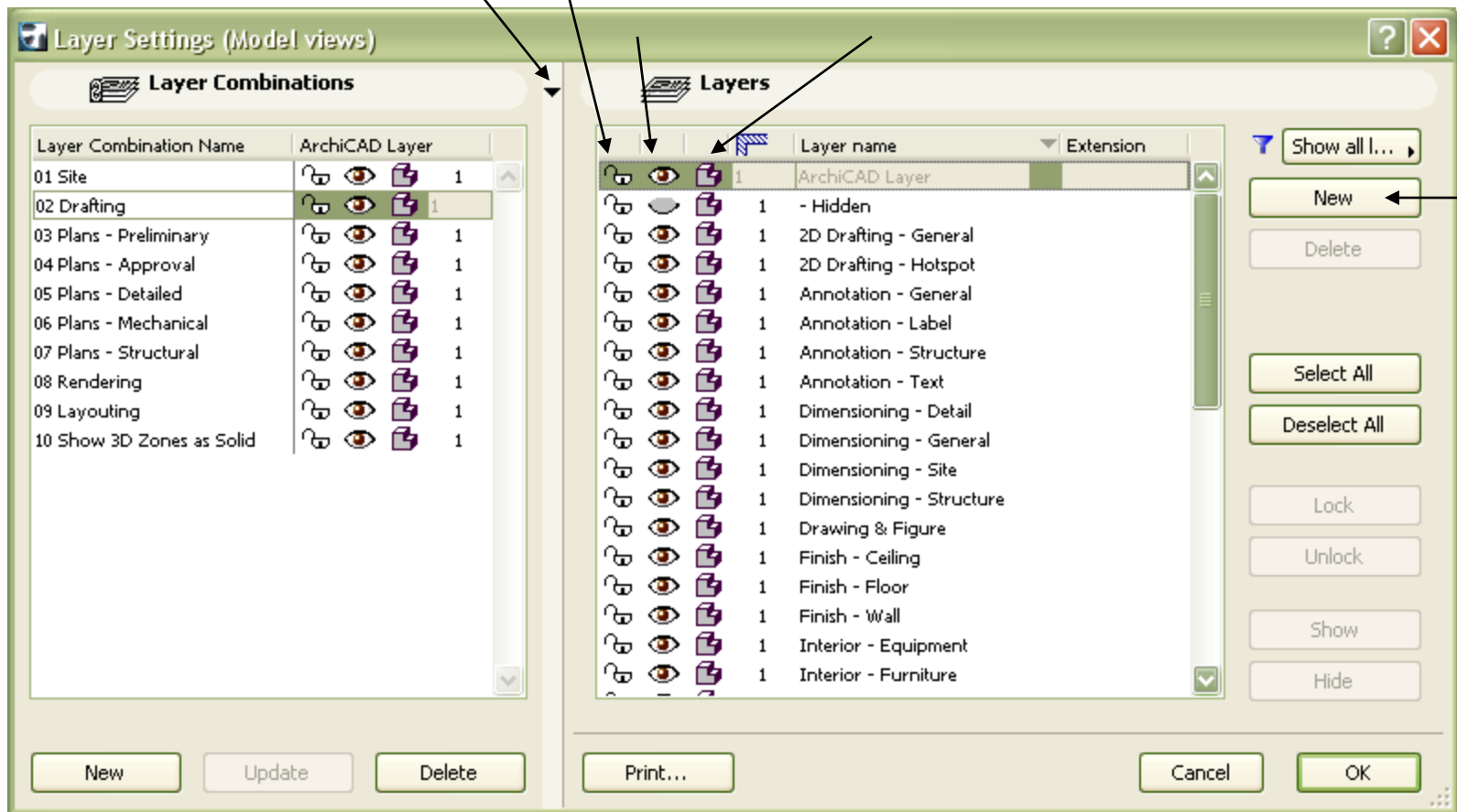

Лејери

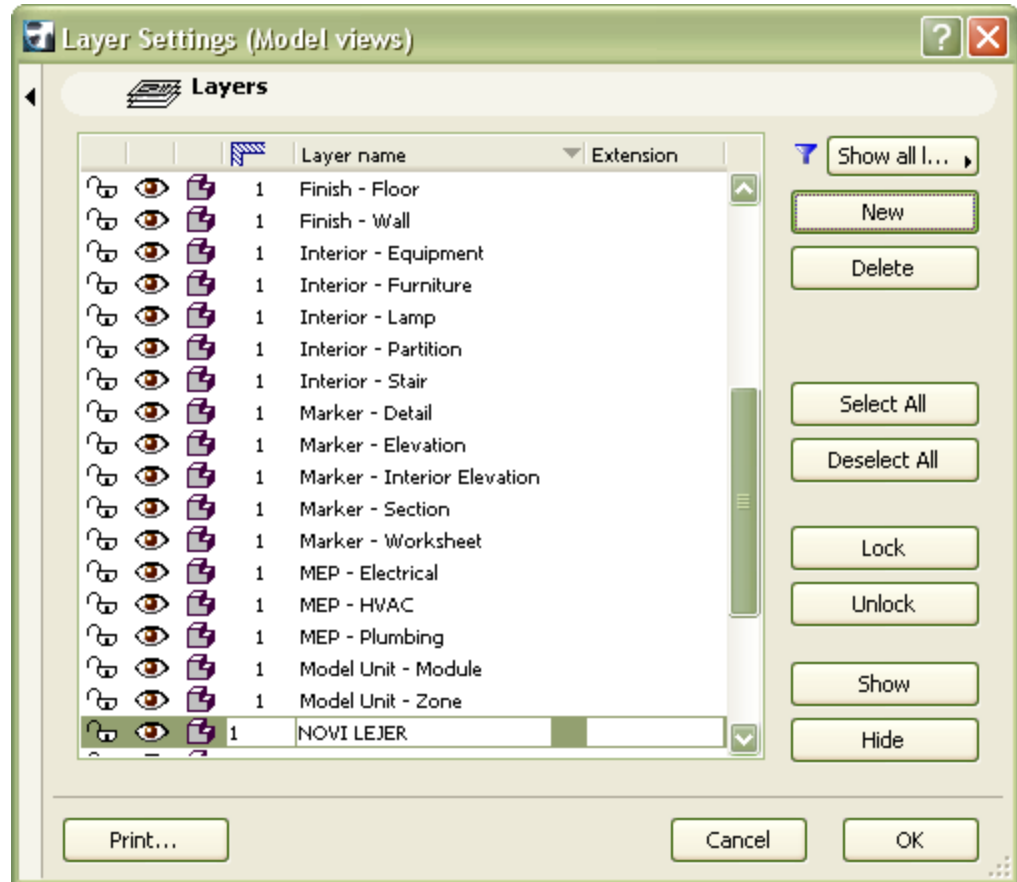
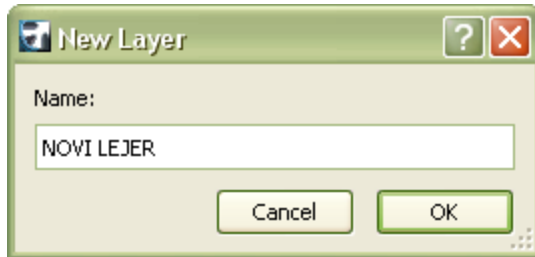



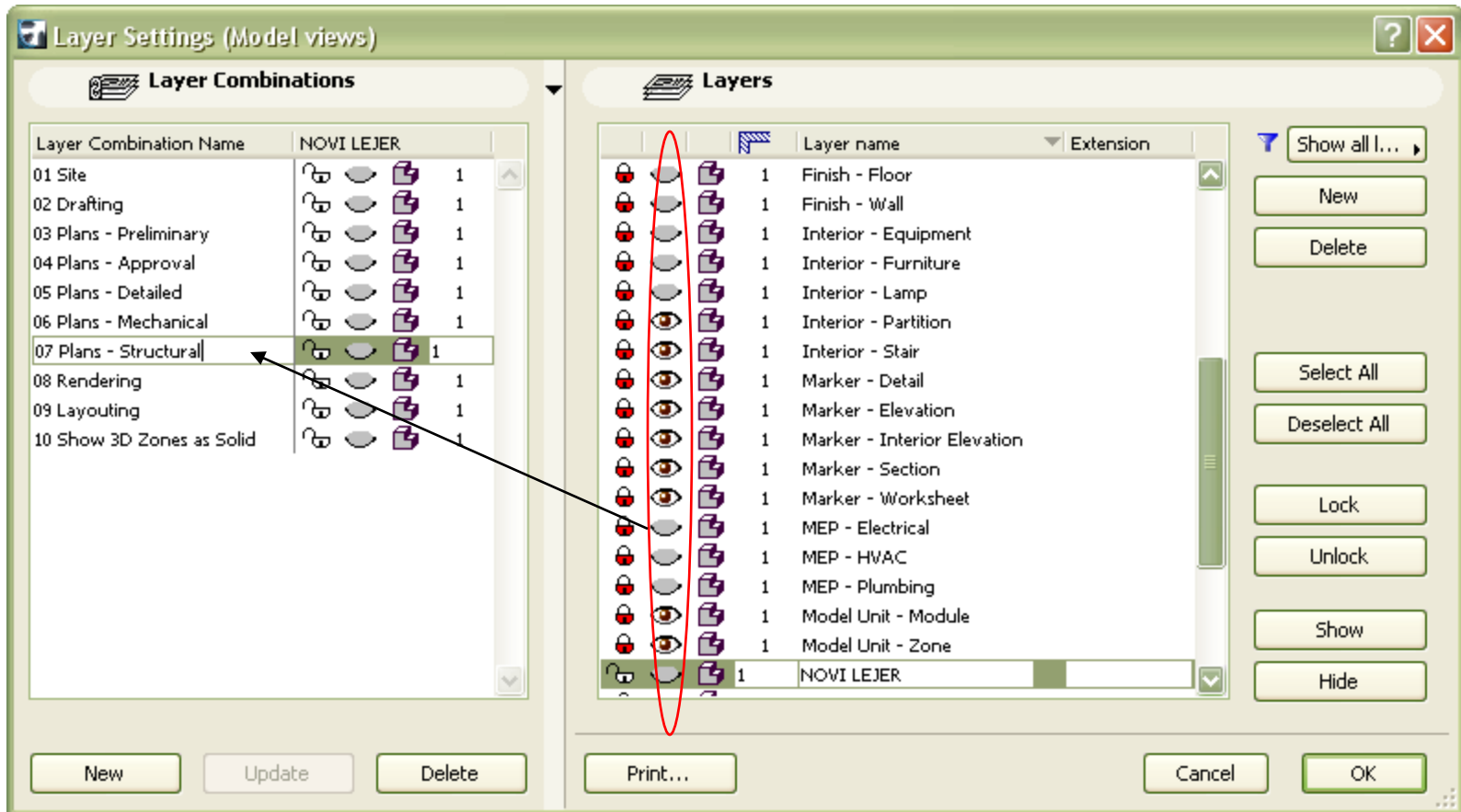

Комбинација лејера

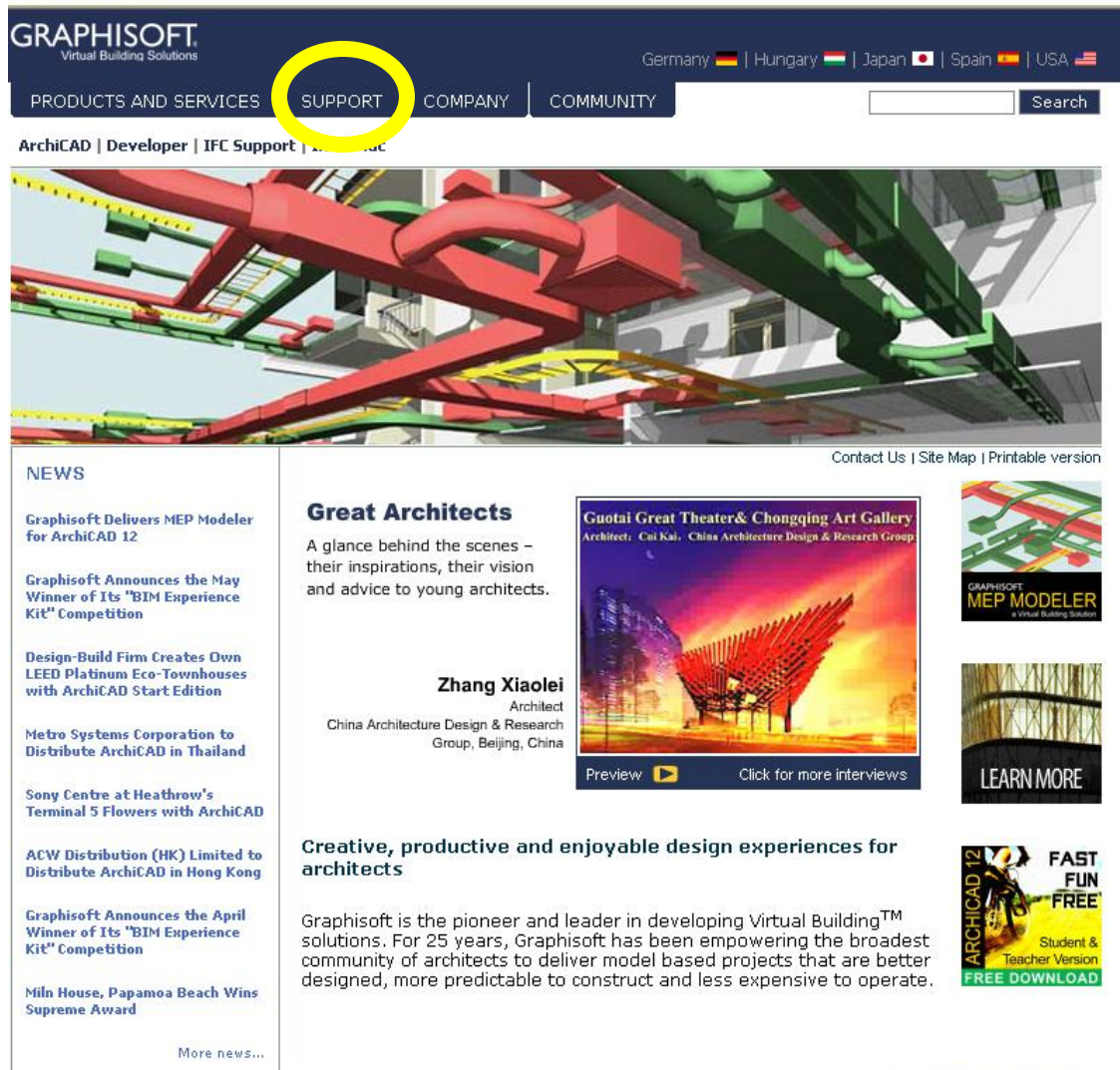

Преузимање лиценце за ArchiCAD



GRAPHISOFT
Virtual Building Solutions

Germany  | Hungary  | Japan  | Spain  | USA 

PRODUCTS AND SERVICES **SUPPORT** COMPANY COMMUNITY

ArchiCAD | Developer | IFC Support | ...

NEWS

- Graphisoft Delivers MEP Modeler for ArchiCAD 12
- Graphisoft Announces the May Winner of Its "BIM Experience Kit" Competition
- Design-Build Firm Creates Own LEED Platinum Eco-Townhouses with ArchiCAD Start Edition
- Metro Systems Corporation to Distribute ArchiCAD in Thailand
- Sony Centre at Heathrow's Terminal 5 Flowers with ArchiCAD
- ACW Distribution (HK) Limited to Distribute ArchiCAD in Hong Kong
- Graphisoft Announces the April Winner of Its "BIM Experience Kit" Competition
- Miln House, Papamoa Beach Wins Supreme Award

More news...

Great Architects

A glance behind the scenes – their inspirations, their vision and advice to young architects.

Zhang Xiaolei
Architect
China Architecture Design & Research Group, Beijing, China

Guotai Great Theater & Chongqing Art Gallery
Architect: Cui Kai, China Architecture Design & Research Group

Preview  Click for more interviews

Contact Us | Site Map | Printable version

MEP MODELER
A Virtual Building Solution

LEARN MORE

ARCHICAD 12 **FAST FUN FREE!**
Student & Teacher Version
FREE DOWNLOAD

support

Преузимање лиценце за ArchiCAD

GRAPHISOFT
Virtual Building Solutions

Germany  | Hungary  | Japan  | Spain  | USA 

PRODUCTS AND SERVICES | SUPPORT | COMPANY | COMMUNITY

Search

ArchiCAD

You are here: [Home](#) → [Support](#)



- ArchiCAD**
- Desktop
- IFC Support
- Intel Mac

[Contact Us](#) | [Site Map](#) | [Printable version](#)

Service and Support

With partners in more than 80 countries, Graphisoft provides an excellent support network, offering you quality service wherever you are.

This section provides you answers to frequently asked questions, or to download updates or free add-ons to Graphisoft products.

Because we know that sometimes the best answers come from you, we maintain very active and lively community sites like the popular [ArchiCAD-Talk Forum](#) and [ArchiCADWiki](#).



Преузимање лиценце за ArchiCAD

GRAPHISOFT
Virtual Building Solutions

Germany  | Hungary  | Japan  | Spain  | USA 

PRODUCTS AND SERVICES | SUPPORT | COMPANY | COMMUNITY

Downloads

You are here: [Home](#) → [Support](#) → [ArchiCAD](#)



[Contact Us](#) | [Site Map](#) | [Printable version](#)

ArchiCAD

[ArchiCAD Wiki](#)

[Documentation](#)

[Downloads](#)

[Links](#)

[System Requirements](#)

[Developer](#)

[IFC Support](#)

[Intel Mac](#)

Related Topics

[Graphics Card Compatibility Database](#)
[ArchiCAD-Talk User Forum](#)
[How to get ArchiCAD?](#)
[Interactive Training Guide](#)
[What's happening?](#)

ArchiCAD Support Area

Welcome to the ArchiCAD Support area!

Here you can find all sorts of information you will need when using ArchiCAD in practice. Your problem may be addressed with a bug fixer patch in the [Downloads](#) section or with a relevant technical note on the [ArchiCAD Wiki](#) site. For information on other ArchiCAD-related pages visit the [Links](#) section of the ArchiCAD Support page.

Latest News:

ArchiCAD to Ecotect add-on connection is now available for download.





July 21, 2008

The add-on is capable to transfer Zone information to Ecotect using gbXML format for analysis. [Click here](#) to download the [Model Preparation Guide](#).



Преузимање лиценце за ArchiCAD

GRAPHISOFT
Virtual Building Solutions

Germany  | Hungary  | Japan  | Spain  | USA 

PRODUCTS AND SERVICES | SUPPORT | COMPANY | COMMUNITY

You are here: [Home](#) → [Support](#) → [ArchiCAD](#) → [Downloads](#)

[Contact Us](#) | [Site Map](#) | [Printable version](#)

ArchiCAD

[ArchiCAD/Wiki](#)

[Documentation](#)

[Downloads](#)

[Links](#)

[System Requirements](#)

[Developer](#)

[IFC Support](#)

[Intel Mac](#)

related Topics

- [Free ArchiCAD Educational](#)
- [Free ArchiCAD Trial](#)
- [Free ArchiCAD Documentation](#)
- [Other GDL Downloads](#)

Downloads

How to update ArchiCAD

In order to keep your ArchiCAD current and always have the latest features and bug fixes you have to update it regularly. New features are introduced in main versions of ArchiCAD while bug fixes are included both in main and sub versions. Main versions are released only on CD while sub versions are downloadable from the internet. To update your ArchiCAD to a newer main version you have to contact your local ArchiCAD provider for an install CD. For bug fixes between main versions, please start ArchiCAD 10 and go to Help menu and click on Check for Updates ... to update your ArchiCAD or click Check for Latest Library... to update your Library. If you use an earlier version of ArchiCAD click [here](#).

WIBU Driver download

Download the WIBU driver recommended by Graphisoft to use with ArchiCAD version 7.0 to version 12 [here](#).

ArchiCAD supports Apple's Tiger

Please read more details [here](#).

PlotFlow for OS X 9.0

The new PlotFlow for MAC OS X.2 and above introduces a new communication method to connect your plotter using network protocols that were not available with previous versions, like Rendezvous, LDP/LPR, AppleTalk etc. Check out the details [here](#). Download Plotflow for OS X 9.0 by clicking [here](#).

Page last updated: *Tuesday, July 22, 2008*

Free
ArchiCAD
Educational



Преузимање лиценце за ArchiCAD

GRAPHISOFT
Virtual Building Solutions

English

Step 1 Step 2 Step 3 Done!

» **Free BIM Experience Kit for Professionals** (Including ArchiCAD) »

Help & Tips

To complete registration you **must enable cookies** in your browser's settings.

If your country or region is not listed in the menu, please select "Others" from the list.

[Click here for details about the registration and download process \(PDF\)](#)

Welcome to the Graphisoft Student & Teacher Registration Webpage!

Graphisoft offers the fully functional Education Version of ArchiCAD® for Students and Teachers. To get a free ArchiCAD Education Version, just follow these steps:

Step 1: Click on the Registration & Download button and provide basic information about yourself to automatically receive an e-mail with the download link and your personal **temporary 30-day serial number**.

Step 2: After you install the program, you can apply for a **one-year renewable serial number**. You only need to provide proof of your student or teacher status to receive your one-year license.

Graphisoft also offers *Academic Version for Schools* which can be obtained by applying with [this form](#).

Choose a Country/Region: [dropdown]
Select a platform: * [dropdown]
Register & Download

- » [Apply for a one-year license](#)
- » [Renew your expired license](#)
- » [Get upgrades and add-ons](#)

About Available Downloads

» [Software Resources](#) » [Interactive Learning](#) » [For Schools](#)

ArchiCAD - 3D Architectural Design	»more info
Artlantis - Rendering and Animation	»more info
Cigraph Plug-ins for ArchiCAD	»more info
Cadimage - ArchiCAD Productivity Tools	»more info
OBJECTIVE - Object modeling tool	»more info

Popuniti
odavde
pa
nadalje